



Form 810025 (01-14)

APPLICATION AND AGREEMENT FOR USE OF HIGHWAY RIGHT-OF-WAY FOR UTILITIES ACCOMMODATION

FOR DEPARTMENT USE ONLY

Permit Number	714-2016-004	Highway Number	IA 10	County	O'Brien
DOT Project Number		F 986 (1)		Expiration/Completion Date	

APPLICANT (INDIVIDUAL OR COMPANY)

First Name	Middle	Last Name	Phone Number	Ext.
Company Name			Phone Number	Ext.
Street Address			State	ZIP Code
1300 Main Street			TX	77002

INSTALLATION TO BE ACCOMMODATED

Approval is hereby requested to enter within the state highway right-of-way for the accommodation of a utility installation as detailed on the attachments and further described as follows:

The installation shall consist of:

The pipeline is a 30 inch Crude Oil line that is to be installed, operated and maintained by Dakota Access, LLC. The pipeline installation (road crossing) will be performed via the bore and jack method. The bore and jack method is a technically advanced process involving specialized equipment and skilled operators. The bore size will be around the same size as the nominal pipe and 120 feet in length

and shall be located as shown on the detailed plan attached hereto. (See current Iowa Department of Transportation Utility Accommodation Policy for submittal of detailed plan requirements.)

WORK SITE LOCATION

The proposed work as described above is located in Section 5 & 8, Twp. 94 North, Range 42 West on Highway No. 10 generally located 0.36 (miles) East (direction) from Monroe Avenue (city, county line, or other land line). Work proposed is more specifically located as being from 37.92 (Milepost #) and 68+81 (Highway Station) to 37.92 (Milepost #) and 68+81 (Highway Station) on the _____ side of highway.

Applicant Signature and Agreement

I have read this Agreement, understand its provisions, and agree to abide by it and the utility accommodation policy of the Iowa Department of Transportation

Name of Agent (Print or Type)	Agent/Owner (Signature)	Title
Rick Hoyer		Land & ROW Manager
Name of Owner (Print or Type)	Date	
Dakota Access, LLC	7-10-2015	

CITY ACTION (IF PROPOSED WORK IS WITHIN AN INCORPORATED CITY, CITY ACTION IS REQUIRED)

"The undersigned city joins in the grants embodied in the above permit executed by the Iowa Department of Transportation on condition that all of the covenants and undertakings therein running to the Iowa Department of Transportation shall inure to the benefit of the undersigned city and recommends action on said permit application as noted below by the delegated city official".

Recommend Approval Do Not Recommend Approval None Required

Handwritten Signature	Title	Date
	Authorized Official for the City of	

COUNTY ACTION (IF PROPOSED WORK CROSSES COUNTY RIGHT-OF-WAY, COUNTY ACTION IS REQUIRED)

"The undersigned county joins in the grants embodied in the above permit executed by the Iowa Department of Transportation on condition that all of the covenants and undertakings therein running to the Iowa Department of Transportation shall inure to the benefit of the undersigned county and recommends action on said permit application as noted below by the delegated county official".

Recommend Approval Do Not Recommend Approval None Required

Handwritten Signature	Title	Date
	Authorized Official for the County of	

(DOT/FHWA Signatures and Agreements on next page)

Special Requirements - In addition to the stipulations below, the following special requirements shall apply to this permit:

FEDERAL HIGHWAY ADMINISTRATION ACTION (WHEN REQUIRED)

Recommend Approval Do Not Recommend Approval None Required

Authorized FHWA Representative Signature

Date

DEPARTMENT OF TRANSPORTATION FINAL ACTION

Application Approved Application Denied

Authorized Highway District Representative

Permit Number

Date

Signature *Blair Klenker*

Notice of intention to start construction or maintenance activities on the highway right-of-way shall be made to:

Local DOT Contact Person (Type or Print Name)

Phone Number

Street Address

City/Town

State

ZIP Code

IA

AGREEMENTS

The utility company, corporation, applicant, permit holder or licensee, (hereinafter referred to as the Permit Holder) agrees with the Iowa Department (hereafter referred to as Department) that the following stipulations and those special requirements as listed on this page shall govern under this permit.

A. General

1. The installation shall meet the requirements of local municipal, county, state, and federal Iowa franchise rules and regulations, regulations and directives of the Iowa State Commerce Commission; the Department of Natural Resources, all rules and regulations of the Department and any other laws or regulations applicable.
2. The Permit Holder shall be fully responsible for any future adjustments of the facilities within the established highway right-of-way caused by highway construction or maintenance operations.
3. Non-compliance with any of the terms of the Department's policy, permit or agreement, may be considered cause for shut-down of utility construction operations or withholding of relocation reimbursement until compliance is assured, or revocation of the permit. The cost of any work caused to be performed by the State in removal of non-complying construction will be assessed against the Permit Holder.

4. The work described in this permit shall be completed as proposed in compliance with the stipulations and special requirements within one year from the date Department approval is received for said request. Failure on the part of the Permit Holder to abide by the stipulations or in constructing the work described as stipulated and within the time frame stated shall render this agreement and request null and void. The Permit Holder also agrees to save the State of Iowa and the Department harmless of any damages or losses that may be sustained by any person, or persons, on account of the conditions and requirements of this agreement.

B. Construction and Maintenance

1. The location, construction and maintenance of the utility installation covered by this application shall be in accordance with the current Department's Utility Accommodation Policy.
2. Before beginning any work in the highway right-of-way, it is the responsibility of the Permit Holder to obtain an easement from the drainage district if necessary. The Department assumes no responsibility for advising the Permit Holder of each location of a drainage district crossing. It is the Permit Holder's responsibility to locate these crossings and obtain any necessary easements or permission from the drainage district. See Code of Iowa, Chapter 468 for additional information.
3. A copy of the approved permit shall be available on the job site at all times for examination by Department officials.
4. All traffic control including sign placement and flagging are the responsibility of the Permit Holder. The original placement of signs and their removal upon completion of the work shall be accomplished by the Permit Holder.
5. Operations in the construction and maintenance of said utility installation shall be carried on in such a manner as to cause minimum interference to or distraction of traffic on said highway.
6. After November 24, 2008, all personnel in the highway right-of-way shall wear ANSI 107 Class 2 apparel at all times when exposed to traffic or construction equipment.

C. Liability

1. The Permit Holder shall indemnify and save harmless the State of Iowa, its agencies and employees, from any and all causes of action, suits at law or in equity, for losses, damages, claims or demands, and from any and all liability and expense of whatsoever nature, arising out of or in connection with the Permit Holder's use or occupancy of the public highway.
2. The state of Iowa and the Department assume no responsibility for damages to the Permit Holder's property occasioned by any construction or maintenance operations on said highway if Permit Holder has been notified in accordance with stipulation number D.3. or if the facilities are not located in accordance with this permit.

3. The State of Iowa, its agencies or employees, will be liable for expense incurred by the Permit Holder in its use and occupancy of the highway right-of-way only when negligence of the State, its agencies or employees, is the sole proximate cause of such expense. Whether in contract, tort or otherwise, the liability of the State, its agencies and employees, is limited to the reasonable, direct expense to repair damaged utilities, and in no event will such liability extend to loss of profits or business, indirect, special, consequential or incidental damages.

D. Notification

1. The Permit Holder is responsible for contacting Iowa One-Call (1-800-282-8988) and request the location of any underground utilities forty-eight (48) hours before excavation. Before beginning work in the highway right-of-way, the Permit Holder shall also contact any other known utility located in the area of the proposed work.
2. The Permit Holder agrees to give the Department forty-eight hours notice of its intention to start construction or to perform routine maintenance on the highway right-of-way. Said notice shall be made to the contact person whose name is shown on this page.
3. The Department shall give the Permit Holder at least forty-eight hours notice of any proposed construction or maintenance work, on either existing or newly acquired right-of-way when the proposed work will be ten feet of a utility location as previously approved by the Department by permit or written agreement. The Permit Holder shall be responsible within this time frame to arrange to protect its facilities.

Disclosure Statement: The information furnished on this form will be used by the Department of Transportation to determine approval or denial of the application. Failure to provide all information will result in denial of the application. Information furnished is public information and copies may be provided to the public upon request.

Special Requirements

Minimum depth/cover to be 5 feet of cover within the ditches as measured from the top of pipe.

No open cuts will be allowed within the right of way.

Only clean material shall be used in the right of way.

Proper drainage shall be maintained at all times. All erosion control that is placed within the right of way shall be maintained. Vegetation shall be restored after completion and it will be the contractor's responsibility to remove any obstructions in the right of way placed by the contractor.

All disturbed areas shall be restored to the IDOT's requirements and satisfaction.

No equipment or material shall be stored in the right of way during non-working hours.

No parking shall be allowed on the shoulders of the roadway.

All access to the work site shall be from approved designated areas by the IDOT.

All crossings shall be constructed as approved by the IDOT.

Crossings of the highway shall be during daylight hours when visibility is clear.

Proper Traffic Control is to be done t all times in accordance to the MUTCD.

Applicant is responsible to notify 511 in advance of highway crossings.

The highway surface shall be kept clean and free of debris at all times.

Applicant is responsible for all highway crossing damages that may occur, repairs shall be done under the direction and satisfaction of the IDOT in a timely manner.

O'BRIEN COUNTY, IOWA

SECTIONS 5 & 8, TOWNSHIP 94 NORTH, RANGE 42 WEST

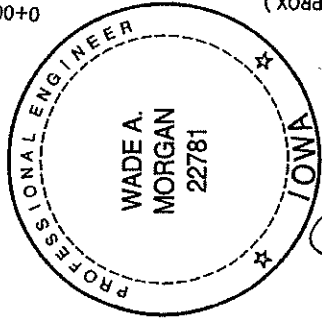
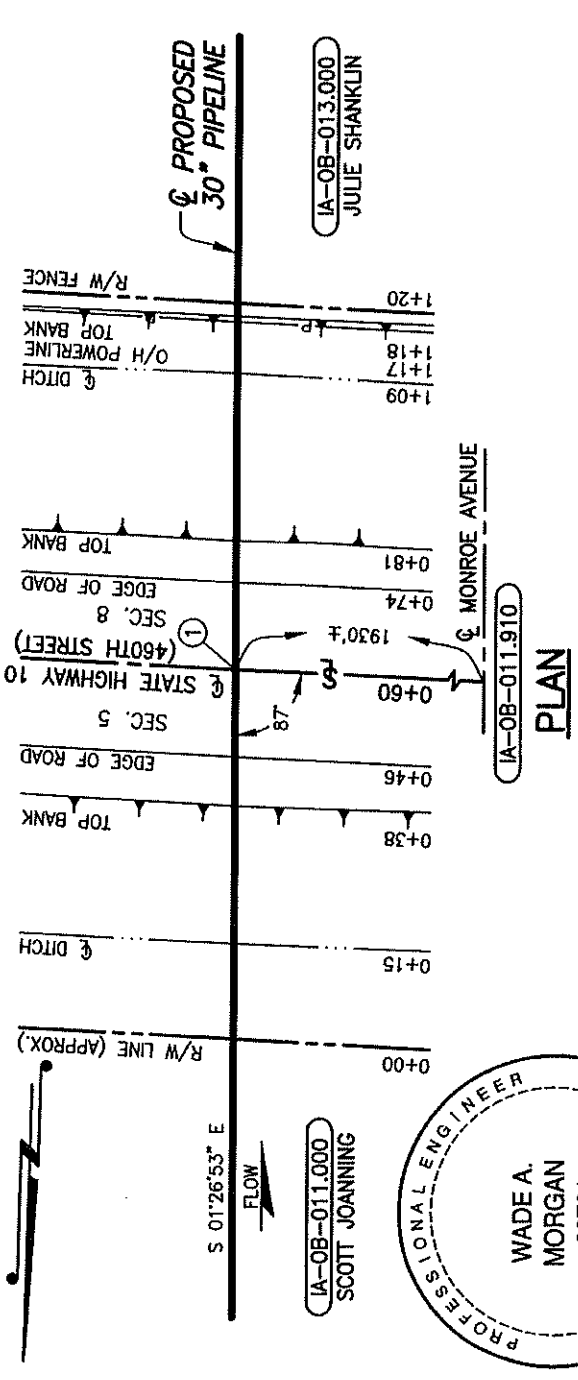

PLAN
SCALE: 1"=30'

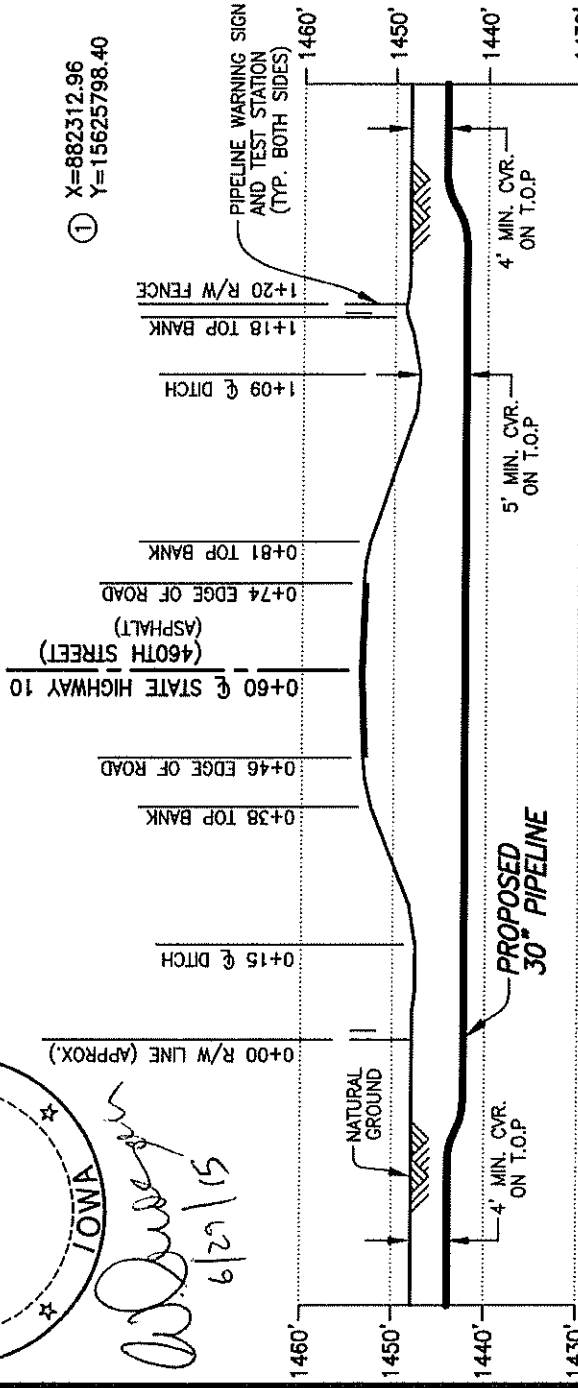

PROFILE
SCALE: 1"=30' HORIZ.
1"=20' VERT.

PIPE SPECIFICATIONS
 PIPE 30" O.D. x 0.625" W.T.
 API 5LX-70 DSAW
 COATING: FBE W/ARO
 SERVICE: CRUDE OIL
 INSTALLATION: BORE
 MIN TEST PRESSURE: 1,800 PSIG
 MOP: 1,440 PSIG
 MIN. YIELD STRENGTH: 70,000 PSI

NOTES:
 CVR. = COVER
 T.O.P. = TOP OF PIPE

DATE: 06/30/15
DATE: 04/13/15
DATE: 02/03/15

DATE: 10/09/14
DATE: 01/29/15

REV.	DATE	BY	DESCRIPTION	CHK.
C	06/30/15	MP	ISSUED FOR USE/PERMIT	AJC
B	04/13/15	MP	ISSUED FOR USE/PERMIT	AJC
A	02/03/15	SR	ISSUED FOR REVIEW	AJC

PROJECT NO. 10395700

WOOD GROUP MUSTANG, INC.

PROPOSED 30" DAPL PIPELINE CROSSING STATE HIGHWAY 10 (460TH STREET)

O'BRIEN COUNTY IOWA

DAKOTA ACCESS, LLC

DATE: 10/09/14
 DATE: 01/29/15

DWG. NO. IA-OB-011.910

APP.: WAM

SCALE: AS SHOWN

REV. C

RURAL DESIGNED AREA
GRANULAR ENTRANCE
CULVERT REQUIRED

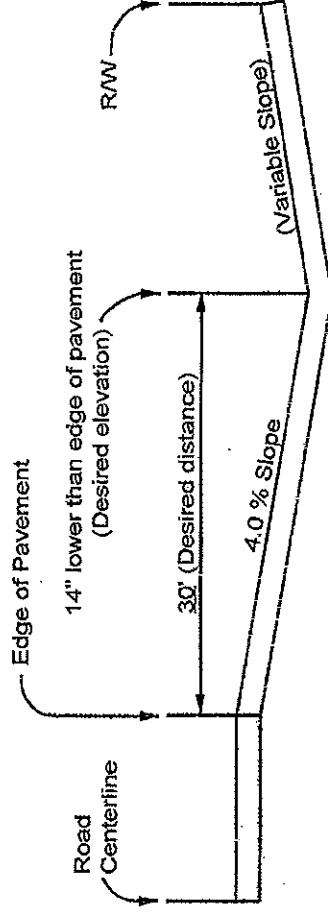
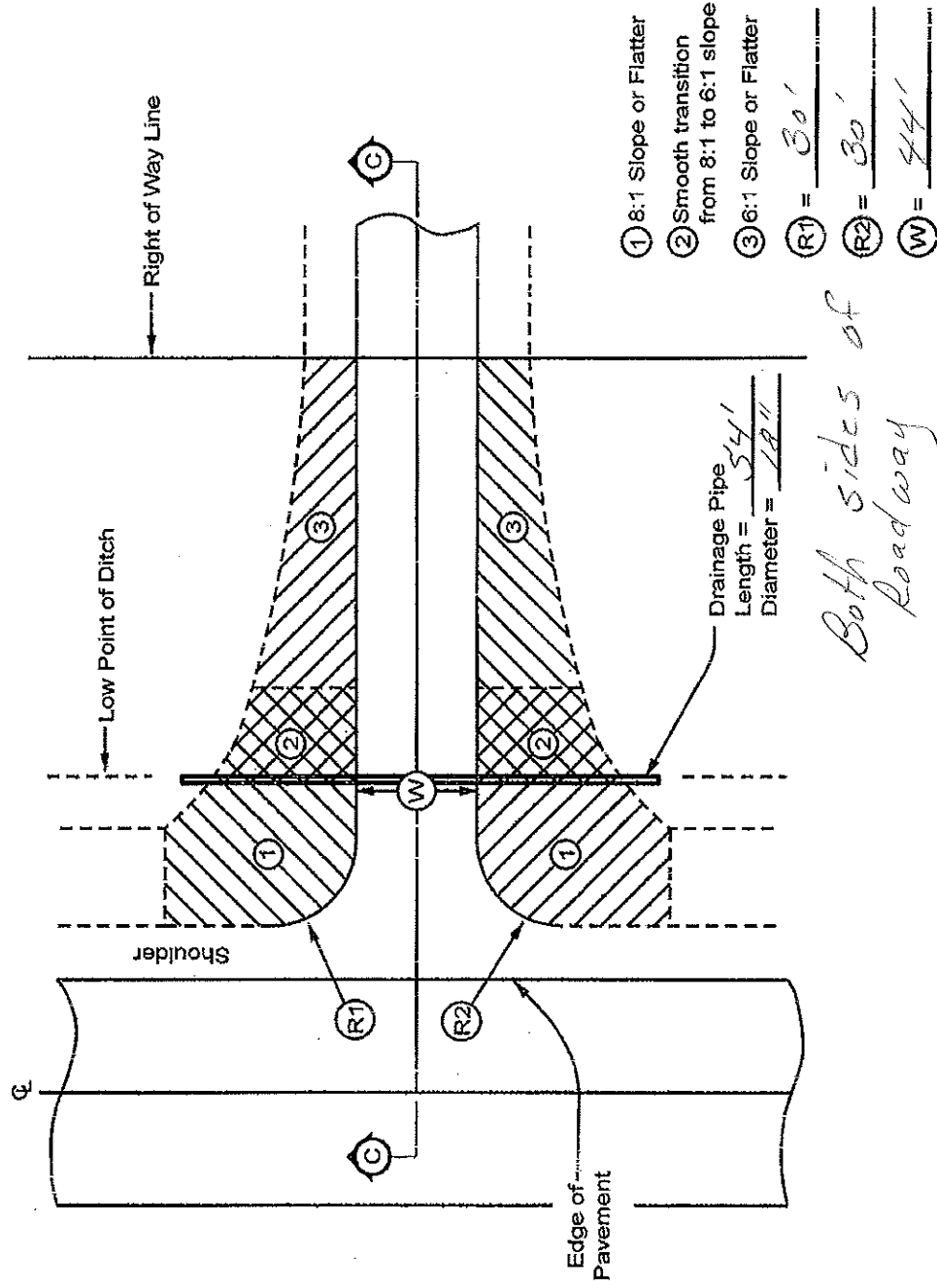

SECTION C - C

Tile Line Repair Guideline

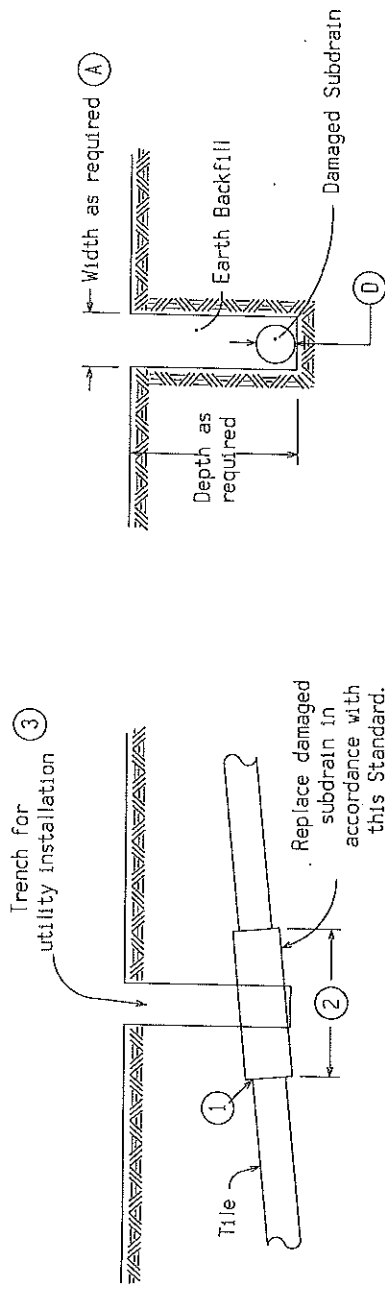

Note:
Replacement of drainage tile shall be accomplished so as to cause the minimum of disturbance to existing field tile. The repaired drainage tile shall be left in a functional condition with special emphasis placed on maintaining existing flow line elevations.

(A) = A minimum of 24" shall be excavated outside the normal utility trench wall or such greater width as may be required to expose a minimum of 12" of undamaged drain tile.

REPLACEMENT SCHEDULE - CASE 'A'												
Existing Tile (1)	4	6	8	10	12	15	18	21	24	24	>24	
Proposed Subdrain Size												
Concrete Pipe	-	-	12	15	15	18	21	24	30	D+6"		
Coated C.M.P.	10	12	15	18	21	24	30	36	36	*		

* Replacement sizes provide equivalent capacity based on 6" settlement assuming a 0.20% slope with $n = 0.013$ for concrete pipe and $n = 0.025$ for corrugated pipe (Manning Formula)

NOTES:

Tile lines disturbed within the right-of-way (outside the Roadway Embankment Area *) limits shall be repaired as follows:

May be repaired with schedule 40 PVC pipe of compatible size or in accordance with the replacement schedule-case 'A' as listed above. Replacement with schedule 40 PVC pipe shall require using a connecting device of a Femco plain and plain flexible pipe coupling or equal.

Tile lines disturbed within the "Roadway Embankment Area" shall be replaced in accordance with the replacement schedule - case 'A' stated above and as follows:

(1) Concrete collar to be placed around joint where existing tile line and corrugated aluminized metal pipe connect.

(2) Minimum length of corrugated metal pipe shall be 4 feet. Minimum length of 2 feet on each side of the tile line break location.

(3) Trench shall be backfilled with 8 inches loose material, compacted to 8 inches with a minimum of 95% compaction of natural density.

A. Backfill and compact area around drain tile to be completed by hand until new tile is completely covered. Remainder of the trench shall be backfilled by acceptable methods.

B. Area shall require inspection by the Iowa Department of Transportation inspectors or their designated personnel prior to backfilling of trench.

* "Roadway Embankment Area" is defined as the area lying between the foreslopes of a two-lane roadway and from near foreslope to far foreslope of a four lane roadway.

Table 2601.03-1: Rural Stabilizing Crop Seeding Rates and Schedule

March 1 through October 31	
Oat	50 lbs. per acre (56 kg/ha)
Grain rye	50 lbs. per acre (56 kg/ha)
Canada wildrye (<i>Elymus canadensis</i>)	5 lbs. P.L.S. per acre (6 kg/ha)
November 1 through February 28 (or 29)	
Oat	62 lbs. per acre (69 kg/ha)
Grain rye	62 lbs. per acre (69 kg/ha)
Canada wildrye (<i>Elymus canadensis</i>)	7 lbs. P.L.S. per acre (8 kg/ha)
For stabilizing crop only, Canada wildrye (<i>Elymus canadensis</i>) seed will not be required to be certified as Source Identified Class (Yellow Tag) Source G0-Jowa.	
Canada wildrye (<i>Elymus canadensis</i>) seed shall be debarbed or equal to facilitate application of seed.	

Table 2601.03-2: Urban Stabilizing Crop Seeding Rates

Bluegrass, Kentucky	122 lbs. per acre (137 kg/ha)
Ryegrass, Perennial (fineleaf variety)	35 lbs. per acre (39 kg/ha)
Fescue, Creeping Red	18 lbs. per acre (20 kg/ha)

Table 2601.03-3: Permanent Seed Rates, Rural Areas

Fescue, Tall (Fawn)	100 lbs. per acre (112 kg/ha)
Ryegrass, Perennial (Linn)	75 lbs. per acre (84 kg/ha)
Bluegrass, Kentucky	20 lbs. per acre (22 kg/ha)

Table 2601.03-4: Permanent Seed Rates, Urban Areas

Bluegrass, Kentucky	122 lbs. per acre (137 kg/ha)
Ryegrass, Perennial (fineleaf variety)	35 lbs. per acre (39 kg/ha)
Fescue, Creeping Red	18 lbs. per acre (20 kg/ha)



www.iowadot.gov

Office of Traffic and Safety
800 Lincoln Way Ames, Iowa 50010
Phone: 515-239-1014
Email: bryan.bradley@dot.iowa.gov

Notification of width or height restrictions on Iowa primary highways – Utility Requirements

To: Utility companies

Subject: Notification of width or height restrictions on Iowa primary highways

Date: February 13, 2014

In accordance with the stipulations on all Utility Accommodation permits, utilities may not obstruct or close primary highways without prior consent of the Iowa DOT, except in emergency situations. The permit holder must notify the DOT 48 hours in advance of its intention to start construction or perform routine maintenance on the highway right-of-way. The purpose of this note is to remind you of these requirements and provide guidance on how to give proper notice and information to the Iowa DOT.

Even short term partial closures can have a significant impact on the operation of highway system. The Iowa DOT is working hard to improve the accuracy of the information provided by the Iowa 511 traveler information system, (<http://511ia.org/>) but we need your help. Besides providing real-time information to the traveling public, this system is also used by the Iowa DOT to route oversize loads. Having accurate information on the location, extent and duration of lane restrictions is critical for their routing processes.

Before setting up a lane closure or any vertical/horizontal restriction on a primary highway, call your local Iowa DOT maintenance garage, as shown on the Iowa DOT Districts web page, <http://www.iowadot.gov/districtshome.html> to discuss timing and date of the closure/restriction. Once the maintenance garage concurs with the timing and date, it is your responsibility to call the Iowa DOT Traffic Operations Center (TOC) at (515-237-3300). The TOC will add the information to the 511

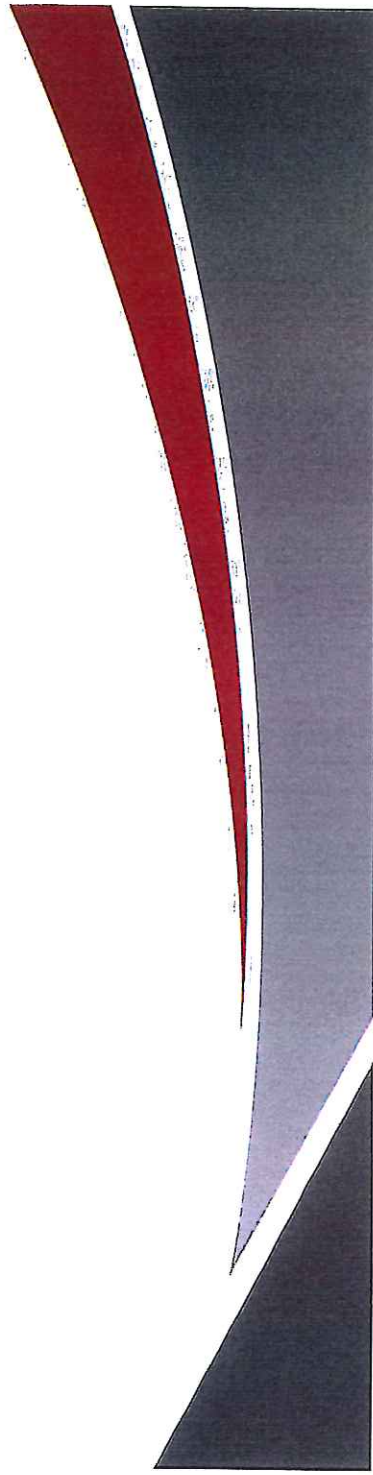

system, which generates an automatic message to Iowa DOT Motor Carrier Services (MCS) and the District office.

This notification does not replace the need for a permit application. Permits are required for utility accommodation and for any and all work on right of way, except emergency work.

Except in emergency situations, 48 hour advance notice is the minimum required. The preference is for a 10 day notice as permits for oversize loads are issued up to 10 days in advance. If a 10 day notice is not possible, MCS will have to check for permitted loads on those routes for possible conflicts and work with the permit holders and DOT Maintenance office to resolve the conflicts. In emergency situations, notification should be provided as soon as possible.

When providing notice to the Iowa DOT, you will need to supply detailed information about the closure. http://www.iowadot.gov/local_systems/mailling/2014/january/511_information_form.pdf It is advised you have this information available when you call the TOC.

If you have any questions, **please do not reply to this note**. Instead, you may contact either your local Iowa DOT maintenance garage or the TOC.

Thank you in advance for your cooperation.

Sincerely,

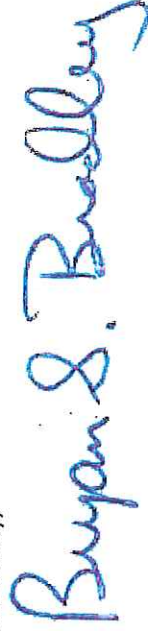

Bryan Bradley
State Utility Engineer
515-239-1014

bryan.bradley@iowa.gov
Iowa Department of Transportation

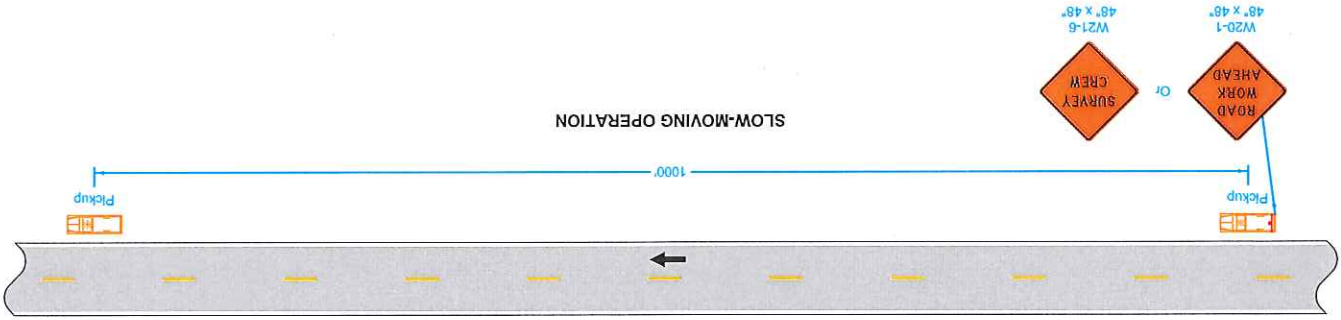
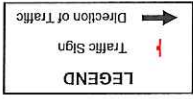

SLOW-MOVING OPERATION



VEHICLE STOPPED ON SHOULDER FOR LESS THAN ONE HOUR

Do not allow work to interfere with the flow of traffic.

When parked, locate vehicles as far from the open traffic lanes as possible. Entrances and driveways should be used whenever appropriate.

Equip all vehicles with an amber revolving light or amber strobe light.

① For work lasting longer than one hour, refer to TC-202 or TC-402.

Possible Contract Item:
Traffic Control

Iowa Department of Transportation	
STANDARD ROAD PLAN	
SHEET 1 of 1 TC-1	REVISION 2 04-16-13
REVISIONS: Modified note concerning amber Vehicle Warning Light.	
APPROVED BY DESIGN METHOD ENGINEER <i>Jessica M. Smith</i>	
WORK NOT AFFECTING TRAFFIC (TWO-LANE OR MULTI-LANE)	

**WORK WITHIN 15 FT
OF TRAVELED WAY**

APPROVED BY DESIGN METHODS ENGINEER
Shawn J. Smith

REVISIONS: Modified general notes, changed title and replaced the DOT logo in the title block with the new version.

STANDARD ROAD PLAN
TC-202

SHEET 1 of 1

REVISION 8 04-21-15

IOWA DOT

Possible Contract Item:
Traffic Control

- ① When the length of a pavement edge drop-off is 1000 feet or less, the temporary fill requirement of Article 1107.08 of the Standard Specifications does not apply. Reduce channelizer spacing to 40 feet.
 - ② For work areas less than 200 feet long, use channelizers spaced at 20 foot centers or use a vehicle with an amber revolving light or amber strobe light.
- For work lasting less than one hour, refer to TC-1.
- Shoulder edge drop-offs shall be milligated according to Article 1107.08.L2 of the Standard Specifications.
- No pavement edge drop-offs greater than pavement depth will be allowed during non-working hours.
- When a pavement edge drop-off exists, install a SHOULDER DROP-OFF sign.

50 or greater	1000'	500'	100'	①	200'
40 - 45	700'	350'	80'	①	200'
35 or less	500'	250'	40'		100'
SPEED LIMIT (mph)	A	B	C	②	T

LEGEND

- Direction of Traffic
- ▨ Work Area
- 42" Channelizer
- ⊥ Traffic Sign

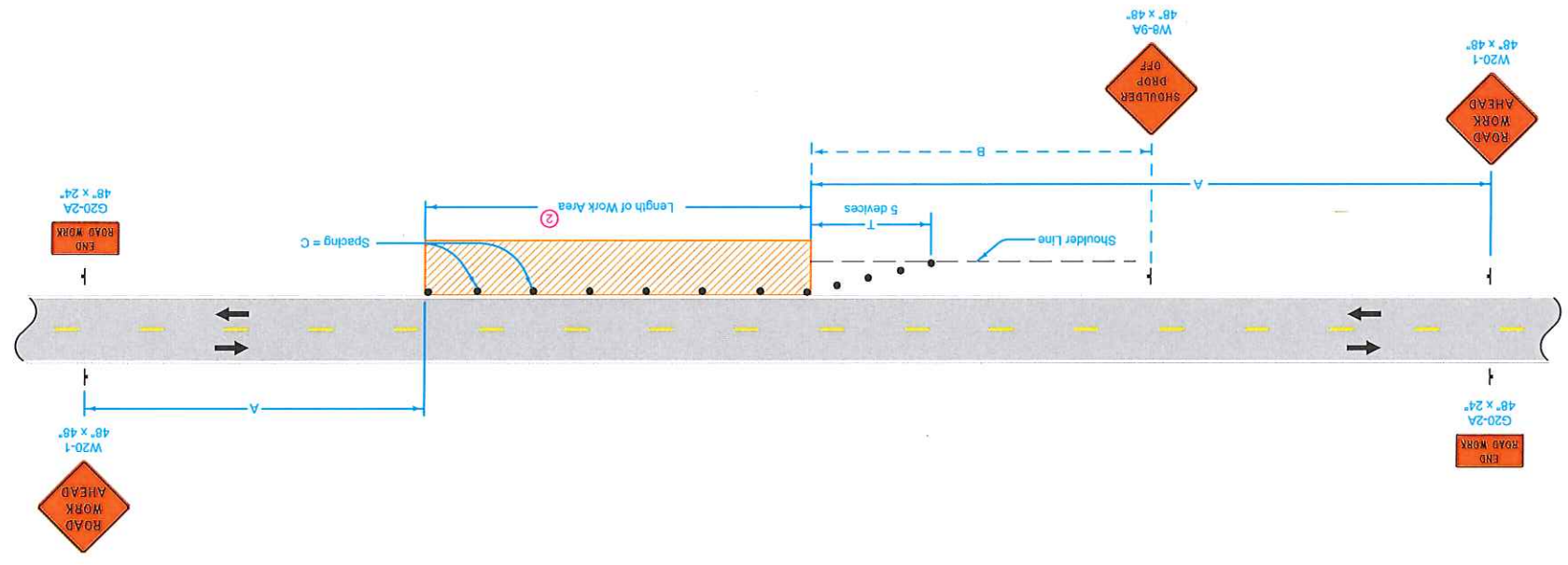

SPOT LOCATION LANE CLOSURE WITH FLAGGERS

APPROVED BY DESIGN METHODS ENGINEERS

James Wright

REVISIONS: Modified cite note 1.

SHEET 1 of 1

STANDARD ROAD PLAN

TC-212

4 04-16-13

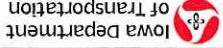

Possible Contract Items:
 Flaggers
 Traffic Control

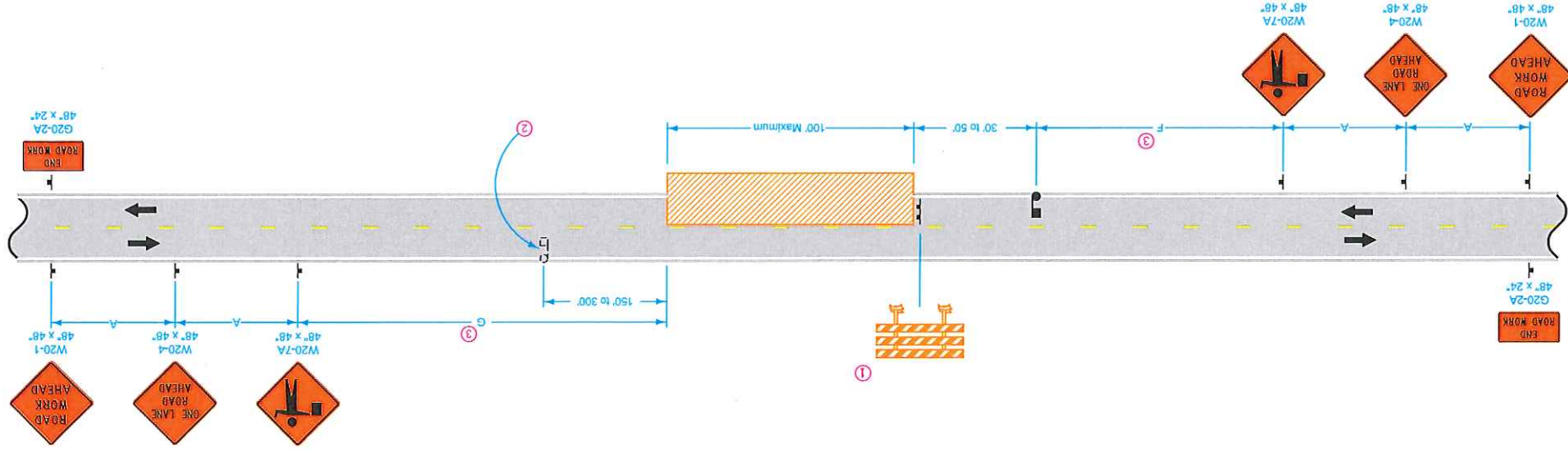

SPEED LIMIT (mph)	F and G Range	F and G Max.
50 or greater	500'	4000'
40 - 45	350'-3350'	3700'
35 or less	250'-3250'	3500'
A	A	A

LEGEND

- Traffic Sign
- Flagger
- Work Area
- Type III Barricade
- Direction of Traffic

- 1 A vehicle with an amber revolving light or amber strobe light may be substituted for the Type III barricade.
- 2 Provide a second flagger if:
 - The flagger's view of approaching traffic in the open lane is less than 1/4 mile or the work site is in an area of restricted sight distance (such as a "No Passing" zone); or
 - Excessive traffic delays are encountered.
- 3 F and G distances are to remain as near minimum values as work permits. However, to be able to move the work area without moving the advance signing, F and G distances may be varied within the limits of the table. Maximum movement can be achieved by setting one F or G value at the minimum and the other value at its maximum.

CONSTRUCTION SITE ENTRANCE

APPROVED BY DESIGN METHOD ENGINEER

James M. J. R.

REVISIONS: Updated references to current standards.

SHEET 1 of 1
TC-273
STANDARD ROAD PLAN

1 04-20-10
 REVISION
 Iowa Department
 of Transportation

Possible Contract Item:
 Traffic Control

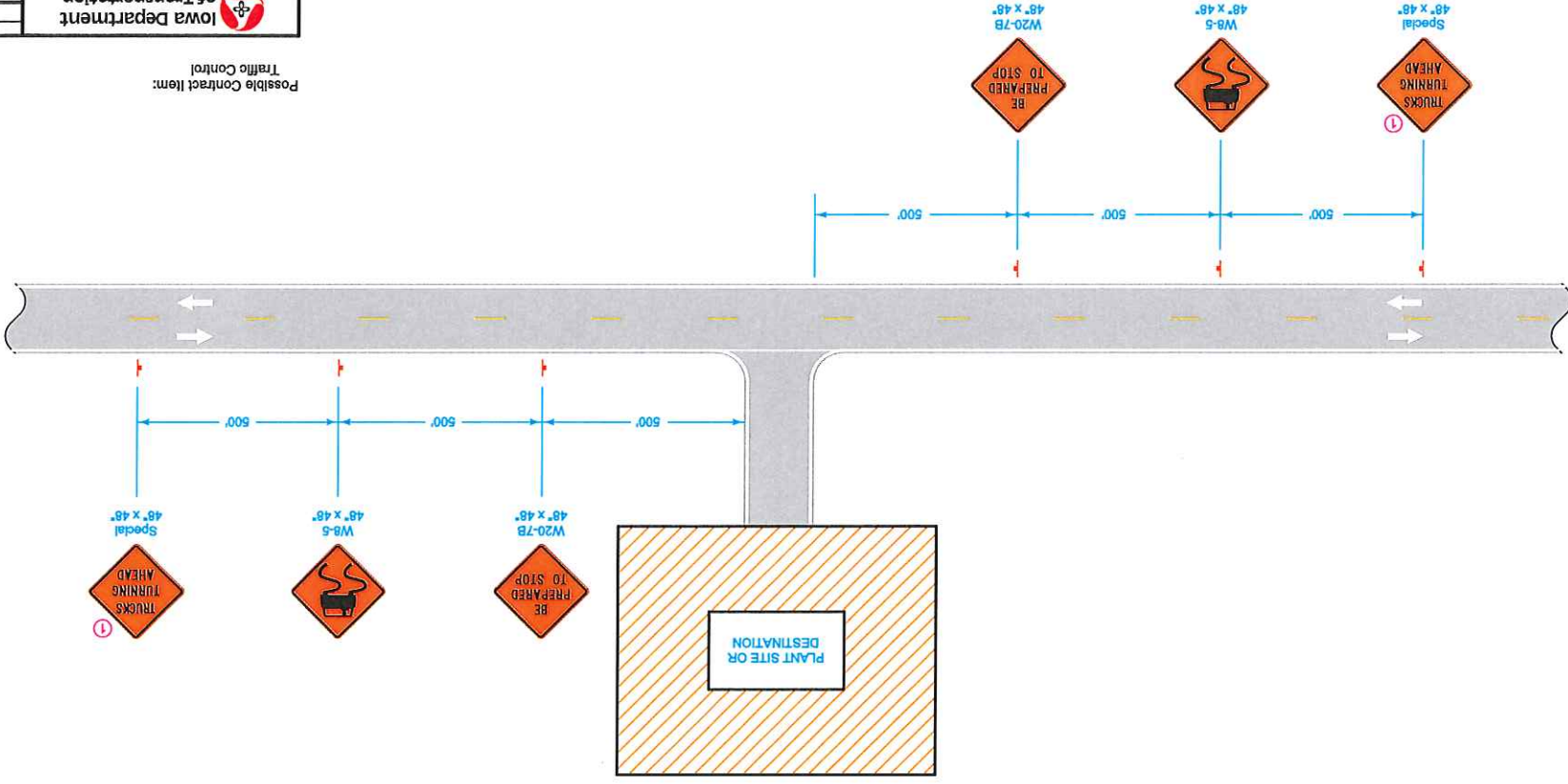
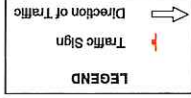

① Refer to SI-881 for details.

Construction traffic shall yield the right-of-way to mainline traffic.

Smoothly shape and round surface and slopes of entrances where practical to provide minimal hazard to an out of control vehicle from through roadway.
 Earthwork and material used for construction of entrances are included in estimate of quantities.

- 1 Locate entrance pipe culverts to coincide with the line of the toe of back slopes as shown. Some special shaping of entrance pipe culverts and cross sections for details of installation.
- 2 Smooth transition to 6:1 at ROW line. If foreslopes of existing entrance are 6:1 or flatter, transition to existing entrance foreslopes.
- 3 Smooth transition from 6:1 to existing foreslope if existing foreslope steeper than 6:1.
- 4 3:1 for new entrance. Existing slope for existing entrance.
- 5 3% for new entrance. Existing slope for existing entrance.

Possible Contract Items:
 Aprons, Unclassified Culvert, Unclassified Entrance Pipe Excavation, Class 10 Possible Tabulation:
 102-3

REVISION 10-20-15 1
 STANDARD ROAD PLAN
 SHEET 1 of 1
 EM-501
 APPROVED BY DESIGN METHODS ENGINEER
 IOWA DOT

RURAL ENTRANCE

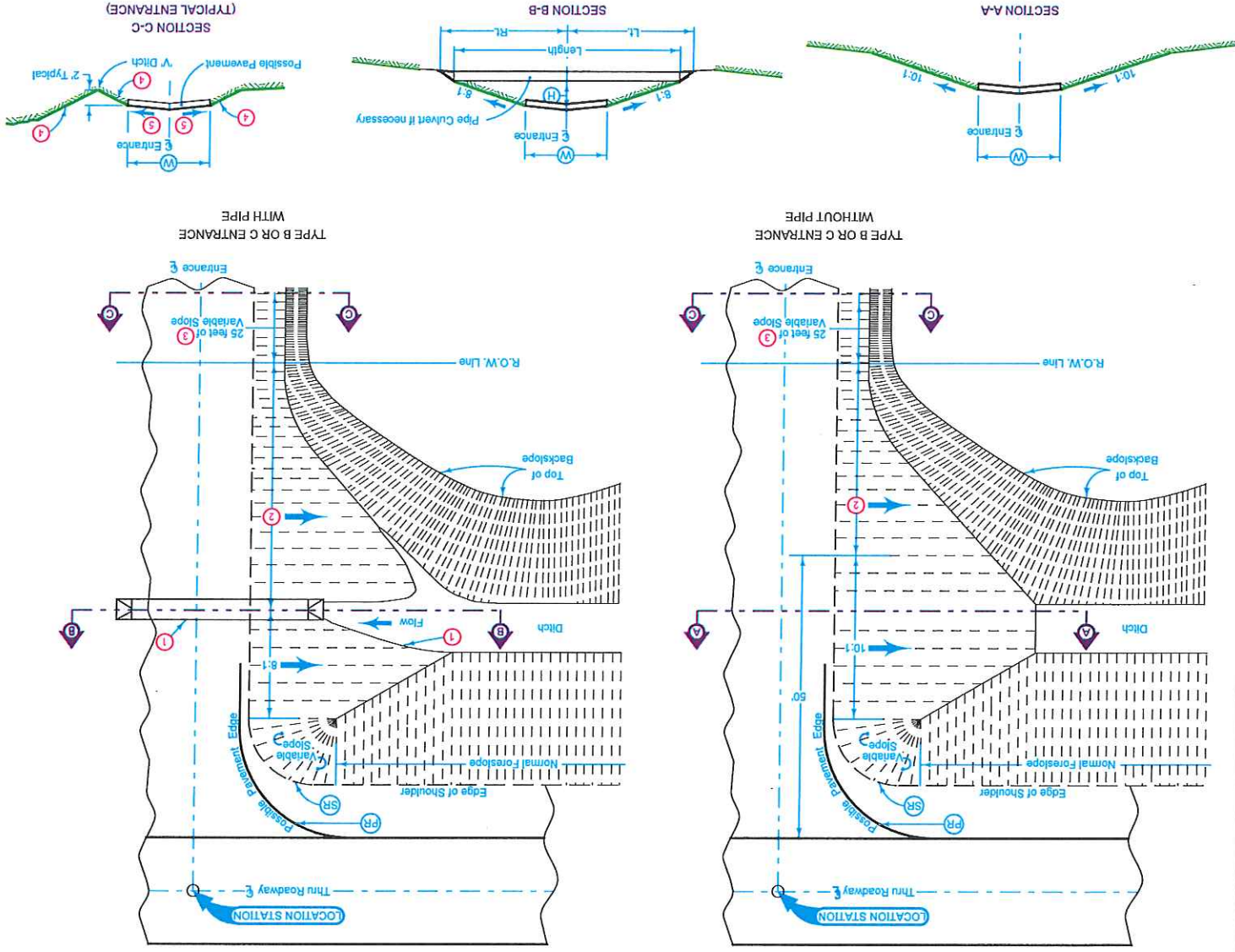

STATION	ELEVATION	REMARKS	DATE
1870			
1880			
1890			
1900			
1910			
1920			
1930			
1940			
1950			
1960			
1970			
1980			
1990			
2000			
2010			
2020			
2030			
2040			
2050			
2060			
2070			
2080			
2090			
2100			
2110			
2120			
2130			
2140			
2150			
2160			
2170			
2180			
2190			
2200			

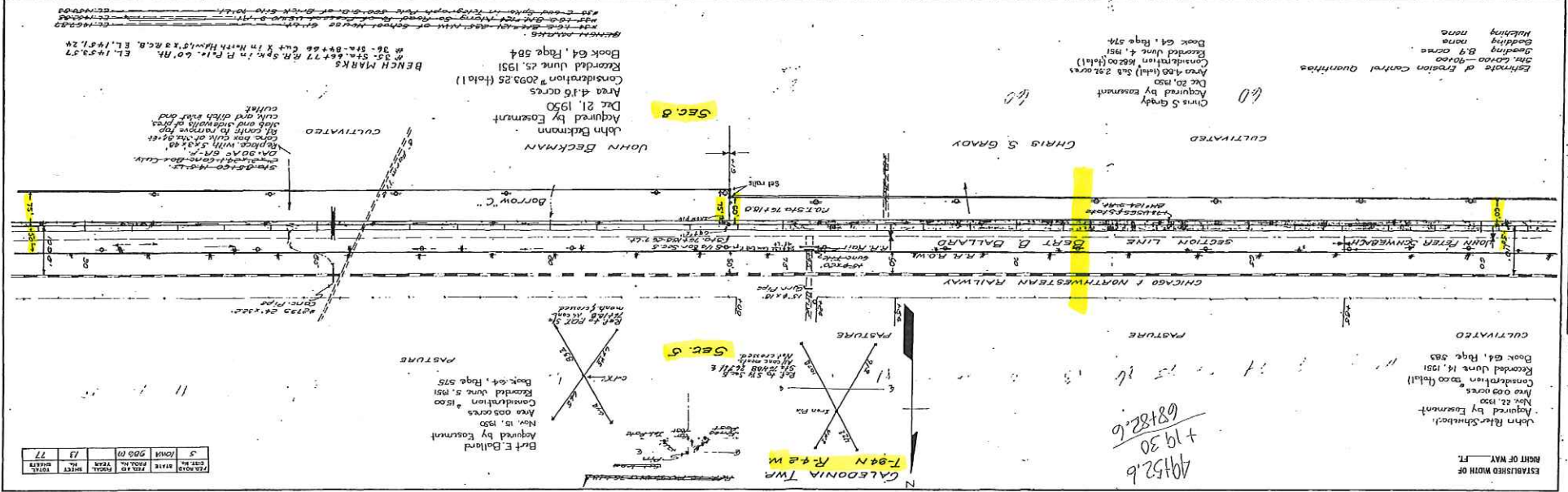

SECTION	TOWNSHIP	RANGE	SHEET NO.	TOTAL SHEETS
5	79th N	2nd W	13	27

Acquired by Easement
 Nov. 15, 1950
 Area 0.05 acres
 Consideration \$1500
 Recorded June 5, 1951
 Book 64, Page 575

Acquired by Easement
 Nov. 15, 1950
 Area 0.05 acres
 Consideration \$1500
 Recorded June 5, 1951
 Book 64, Page 575

Acquired by Easement
 Dec 21, 1950
 Area 4.16 acres
 Consideration \$2093.25 (Total)
 Recorded June 25, 1951
 Book 64, Page 584

BENCH MARKS
 # 35- Sta. 62+77 R.R. Sp. in P.P. in 60th R.R.
 E.L. 1453.57
 # 36- Sta. 88+55 cut X in North Half of 3rd R.R. B.L.
 E.L. 1457.24

19452.6
 + 1930
 68482.6

Acquired by Easement
 Nov. 22, 1950
 Area 0.05 acres
 Consideration \$1000 (Total)
 Recorded June 14, 1951
 Book 64, Page 583

Chris S Grady
 Acquired by Easement
 Dec 20, 1950
 Area 1.86 (Total) Sub 2.91 acres
 Consideration \$2000 (Total)
 Recorded June 4, 1951
 Book 64, Page 574

SECTION	TOWNSHIP	RANGE	SHEET NO.	TOTAL SHEETS
5	79th N	2nd W	13	27

SECTION	TOWNSHIP	RANGE	SHEET NO.	TOTAL SHEETS
5	79th N	2nd W	13	27