

# Pfeiler Road East Preliminary Design

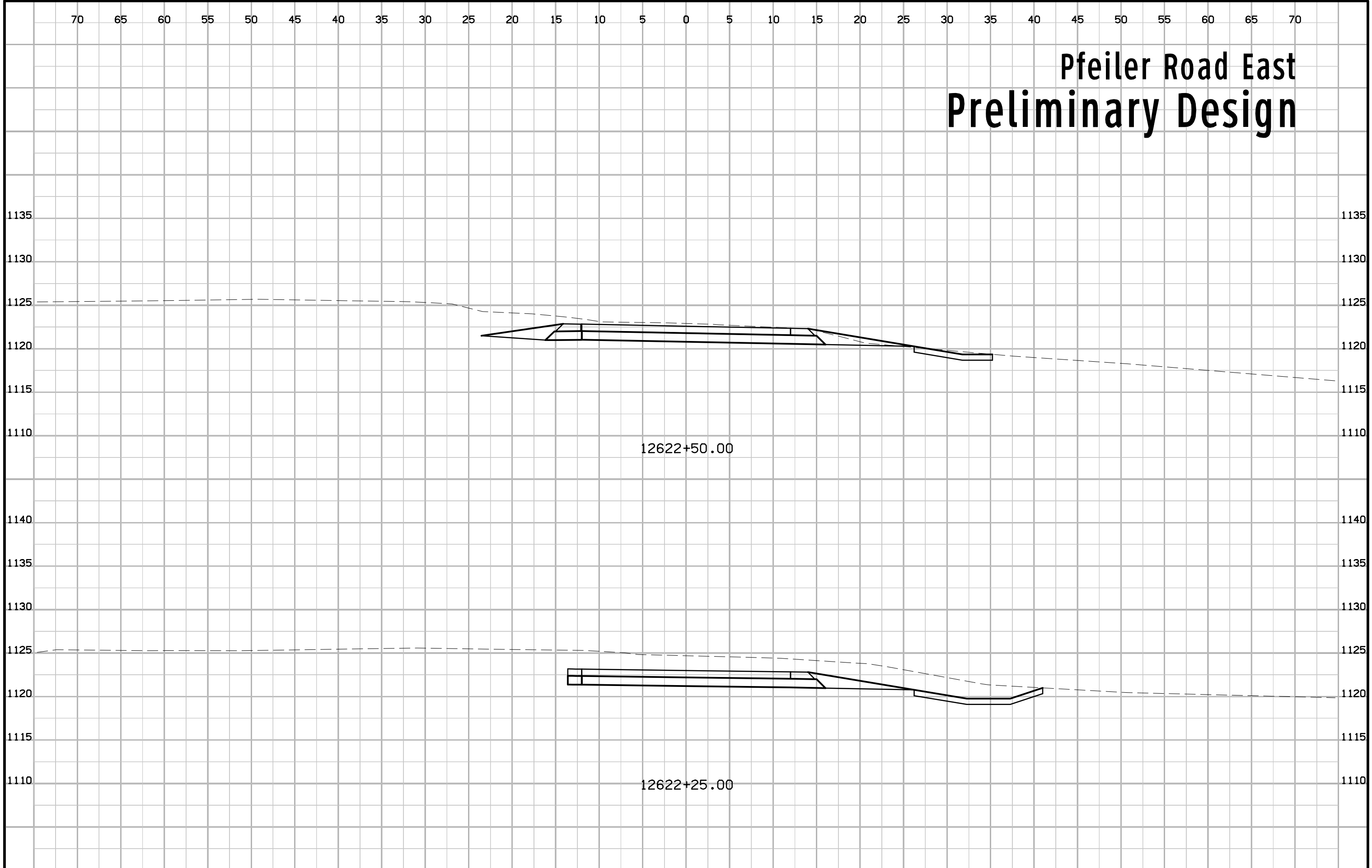

# Pfeiler Road East Preliminary Design

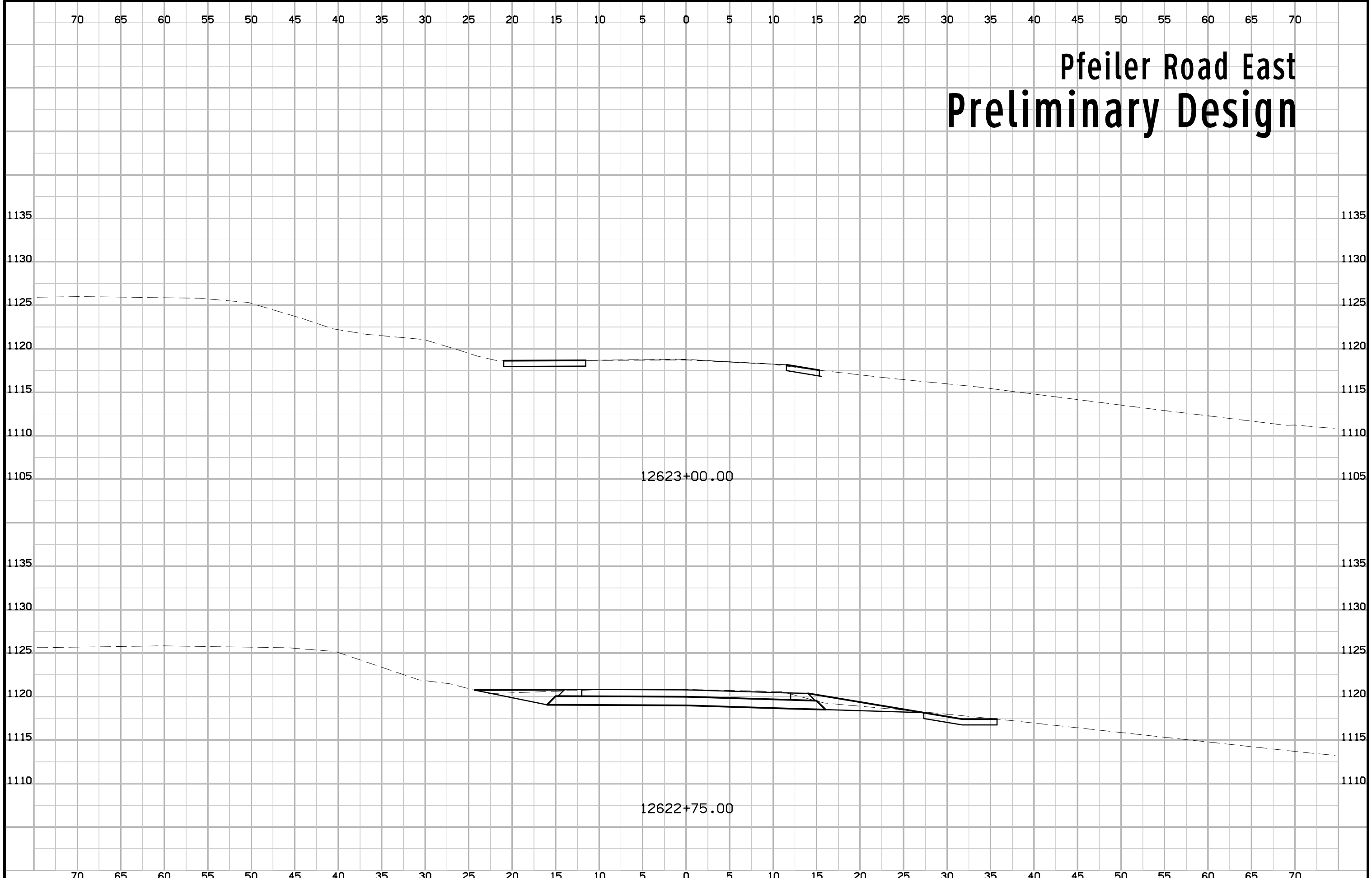

# Pfeiler Road East Preliminary Design

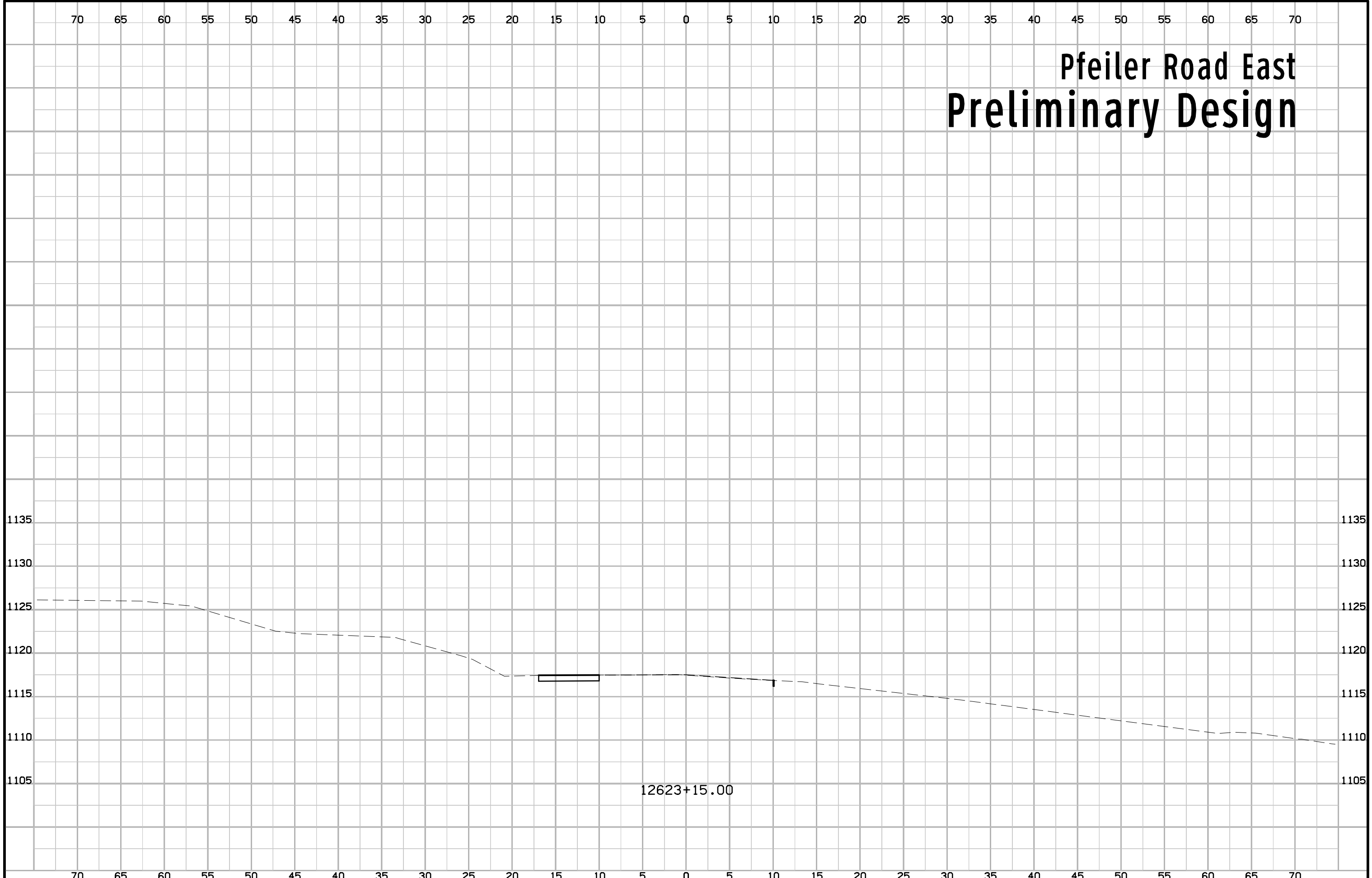

# Hingtgen Lane Preliminary Design

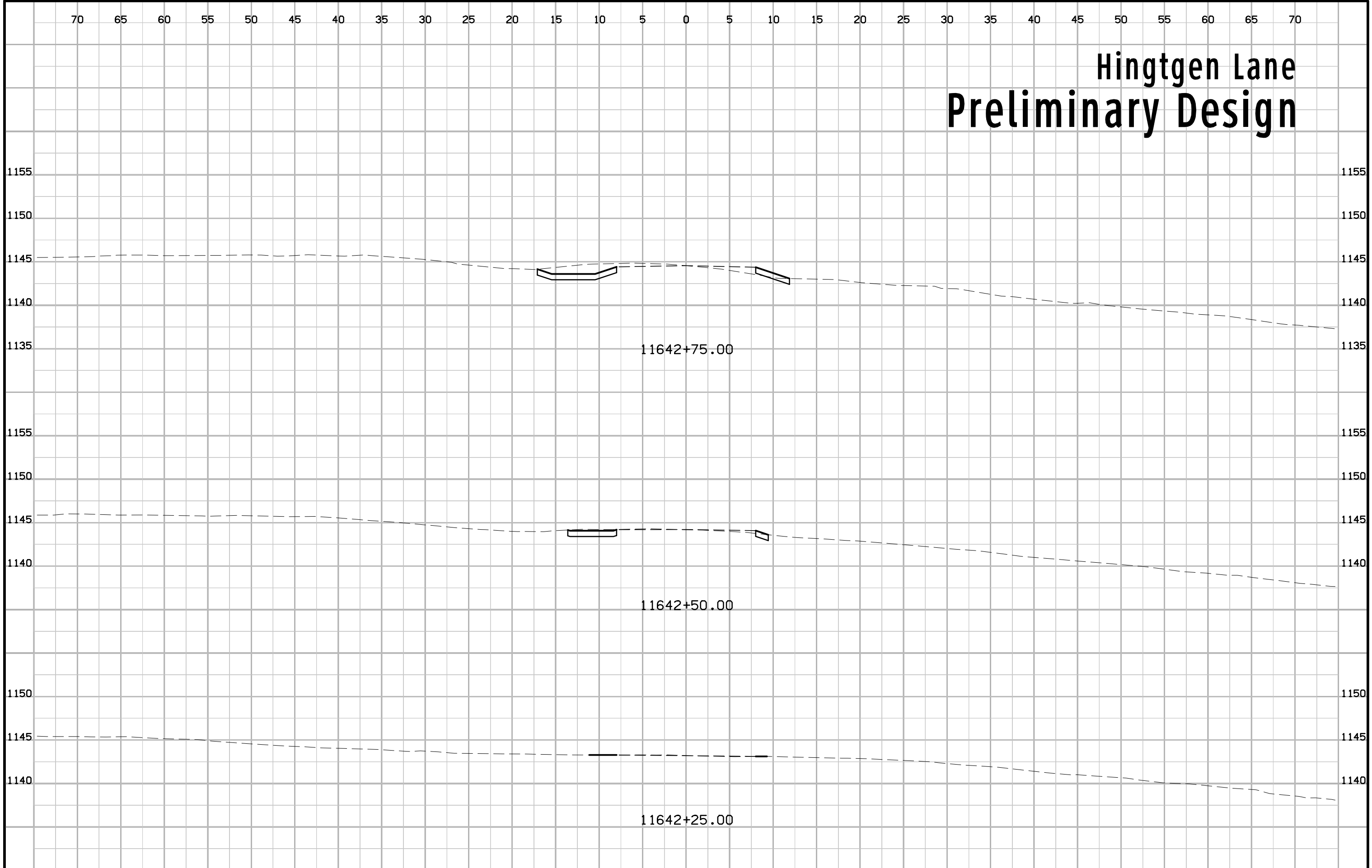

# Hingtgen Lane Preliminary Design

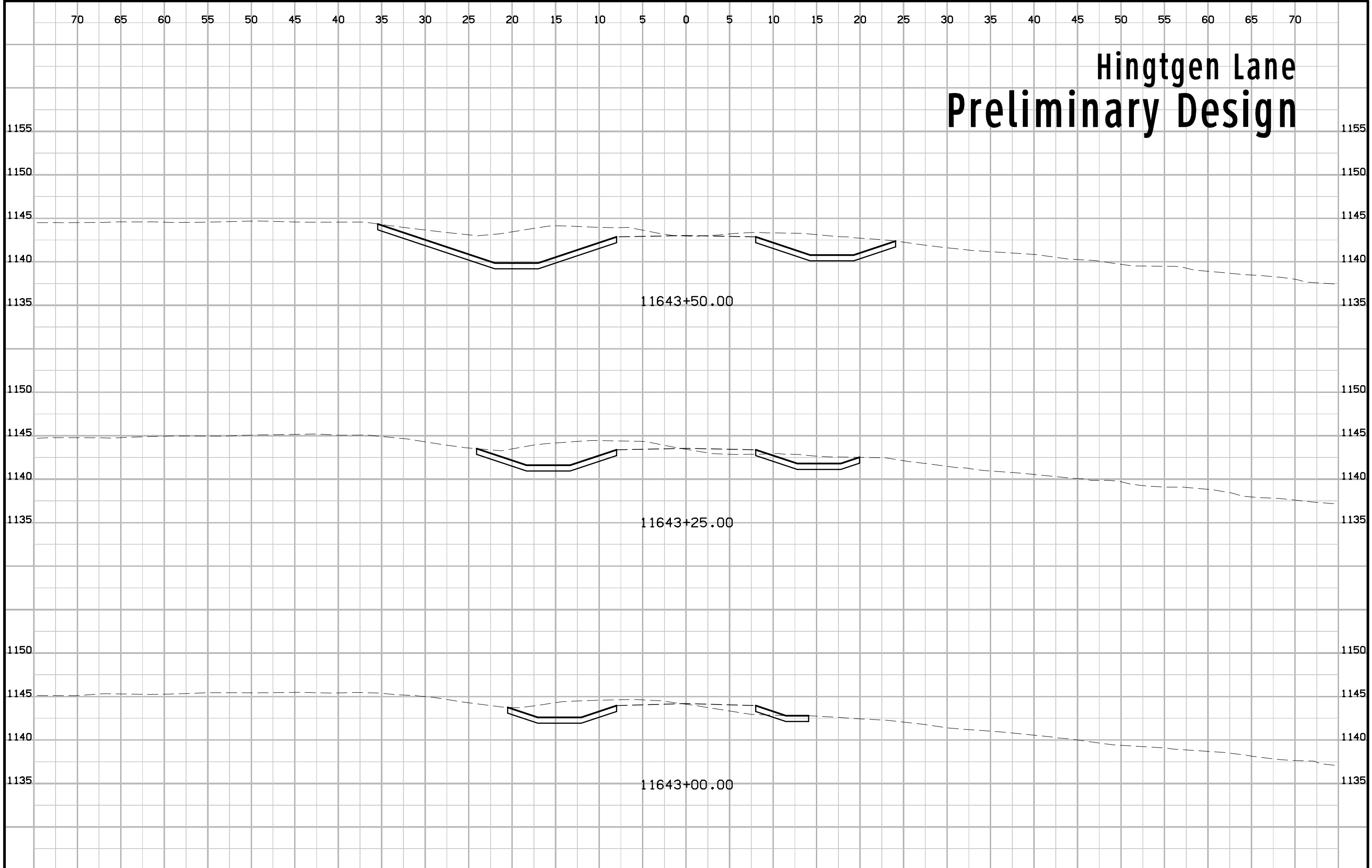

# Hingtgen Lane Preliminary Design

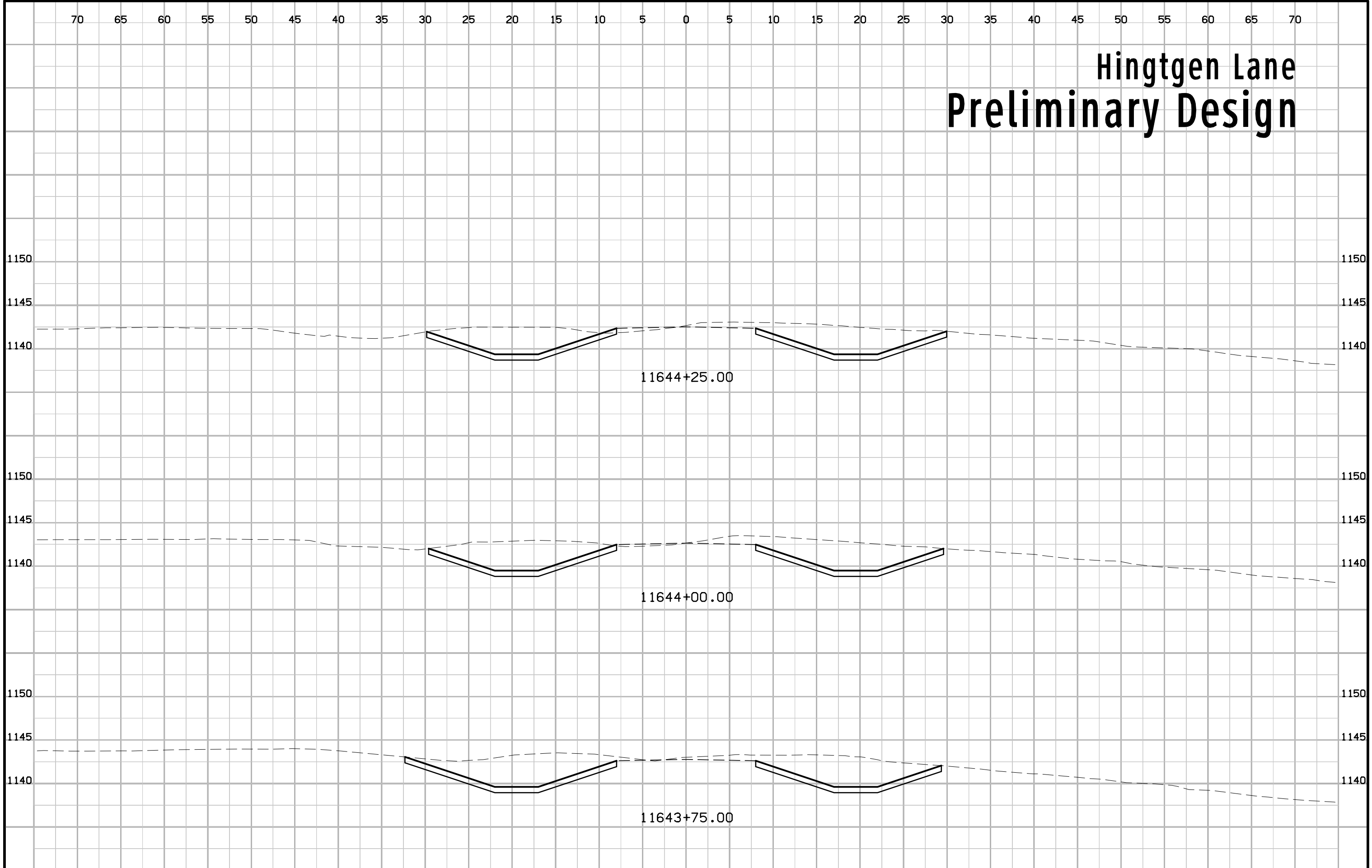

# Hingtgen Lane Preliminary Design

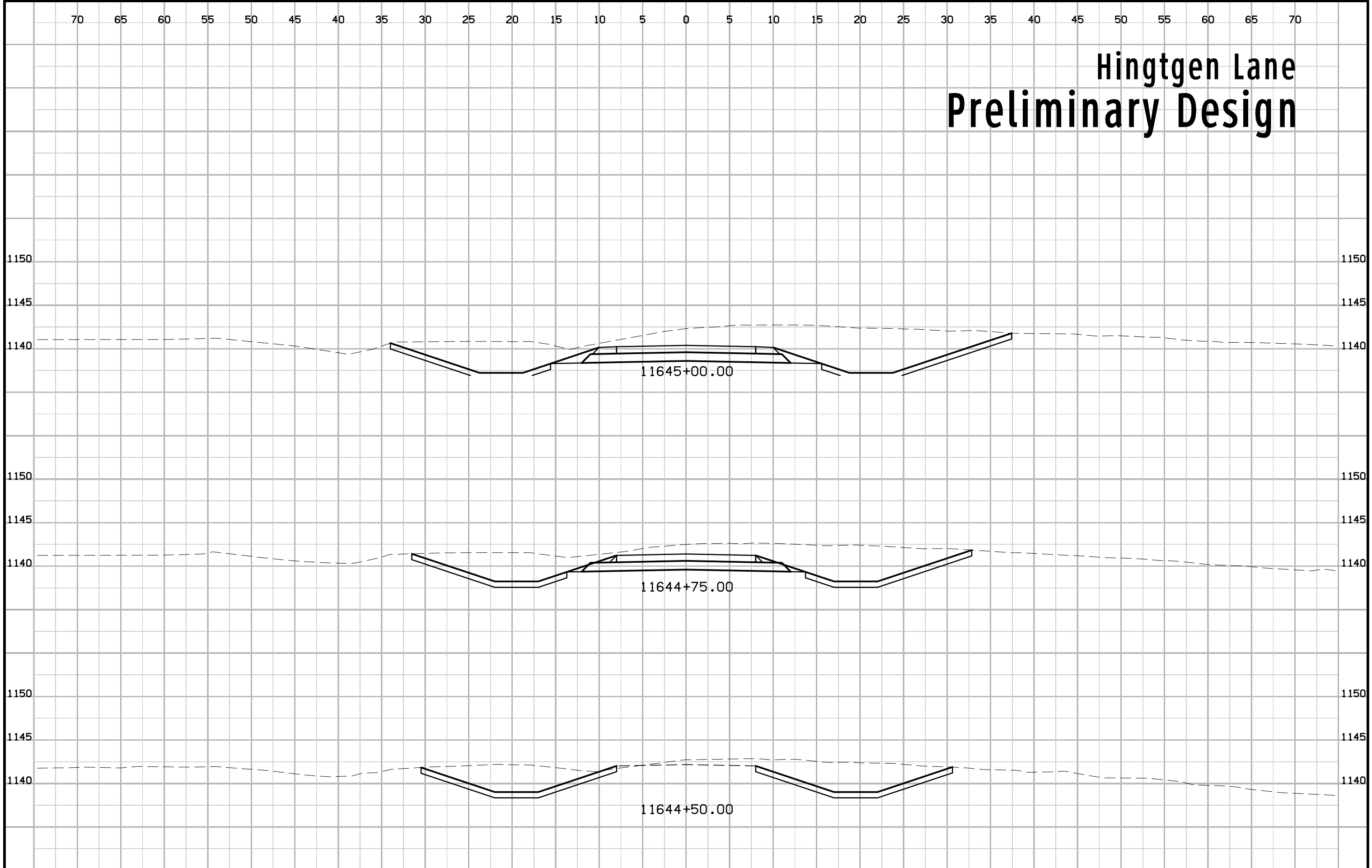

# Hingtgen Lane Preliminary Design

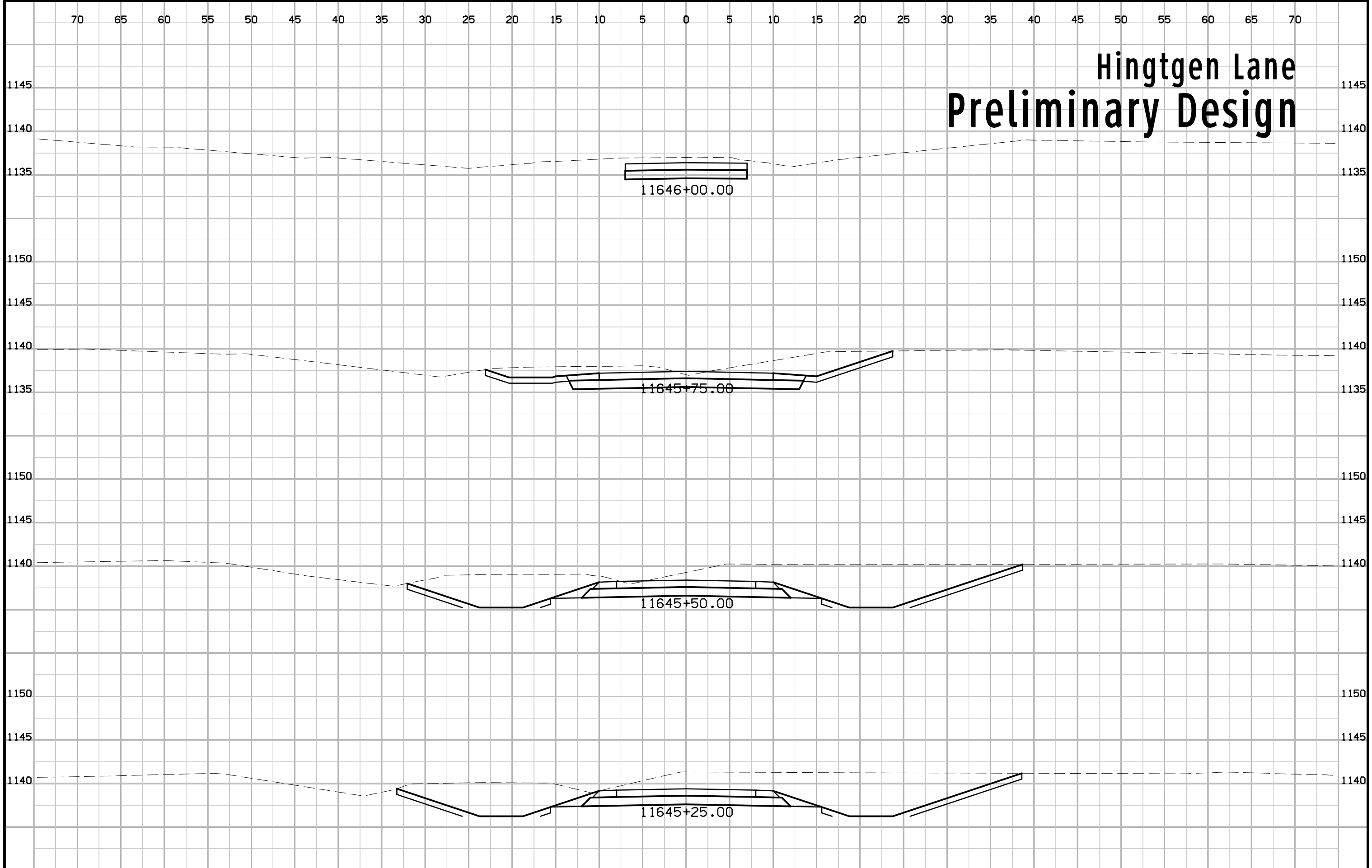



# Midway Road Preliminary Design

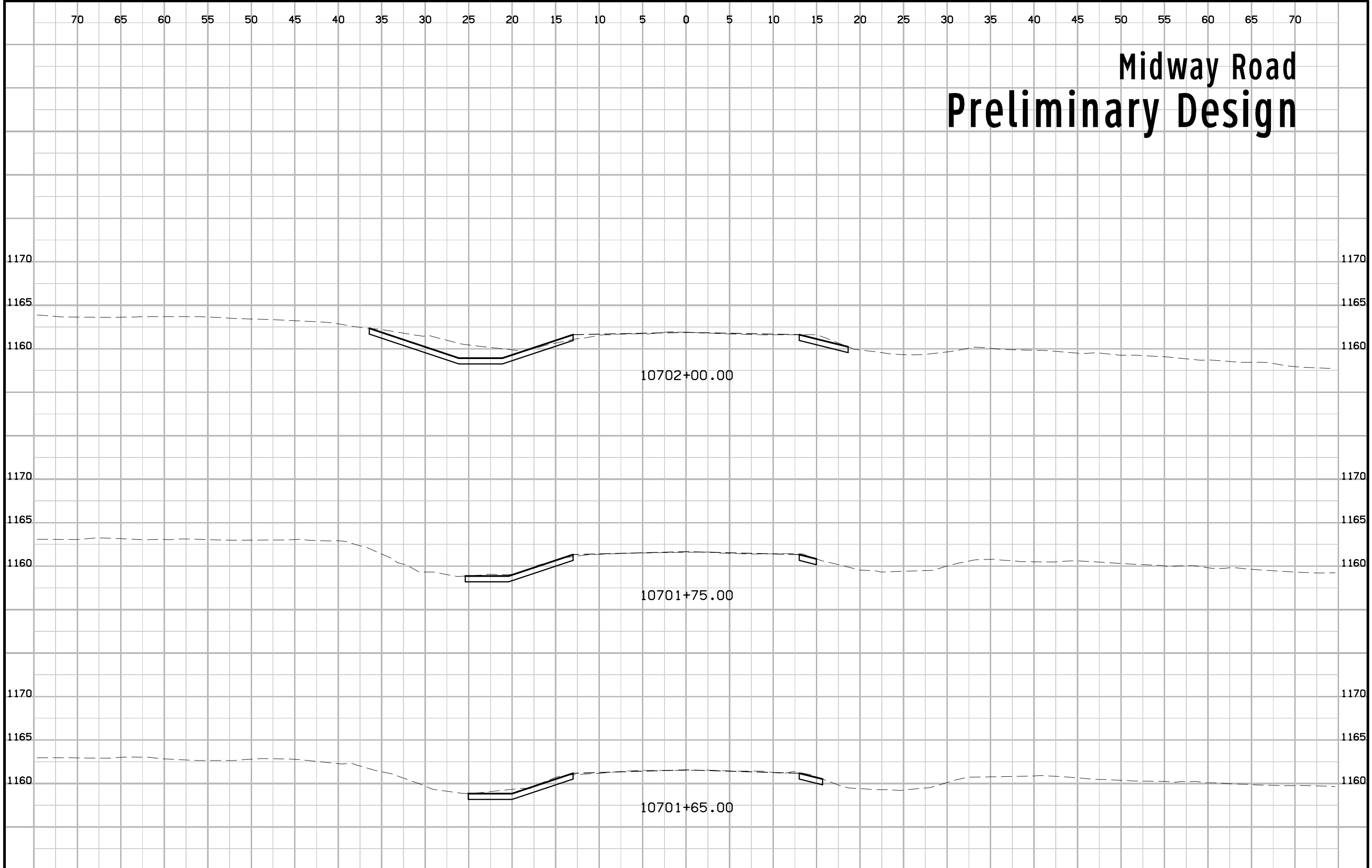

# Midway Road Preliminary Design

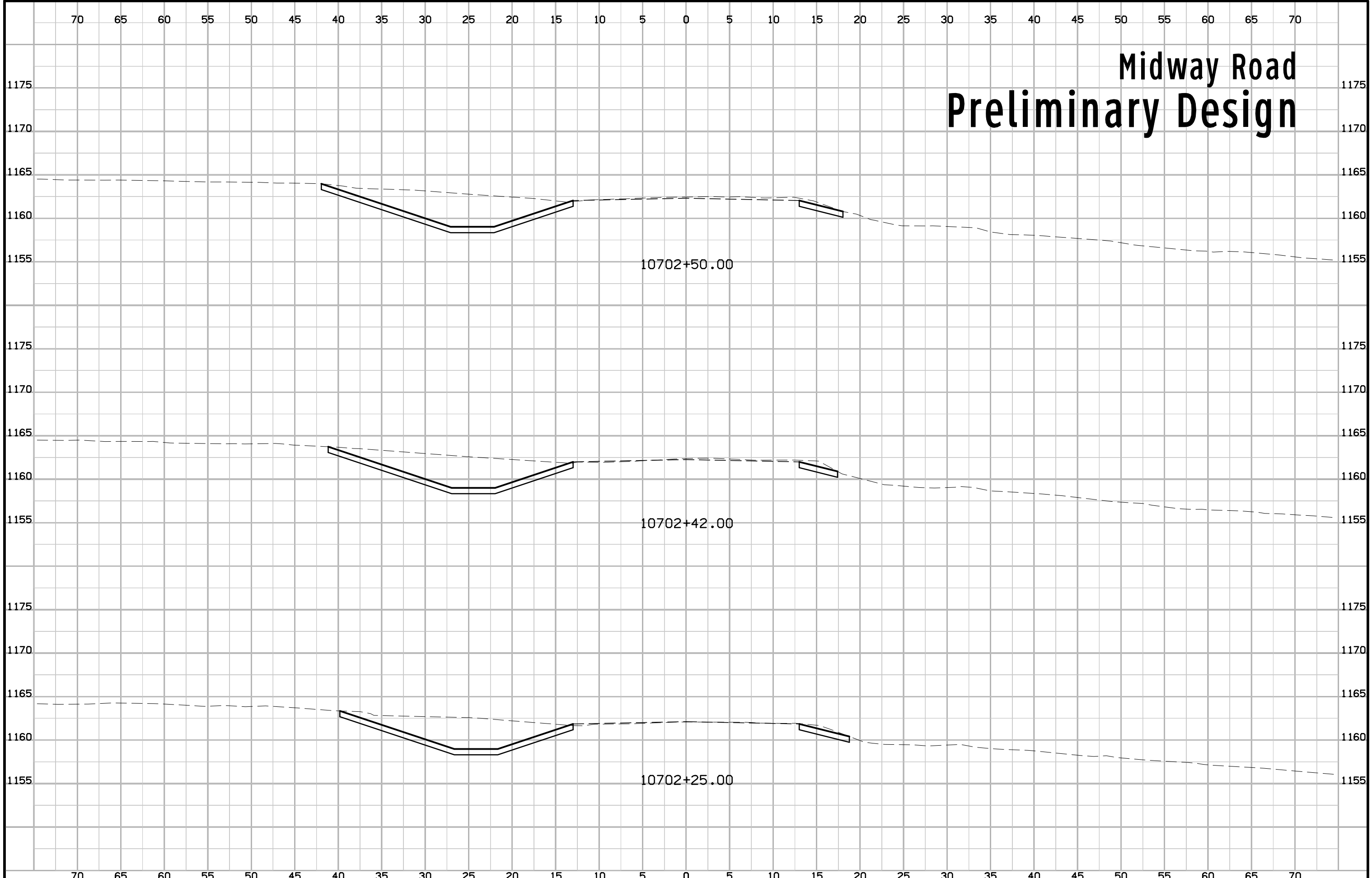

# Midway Road Preliminary Design

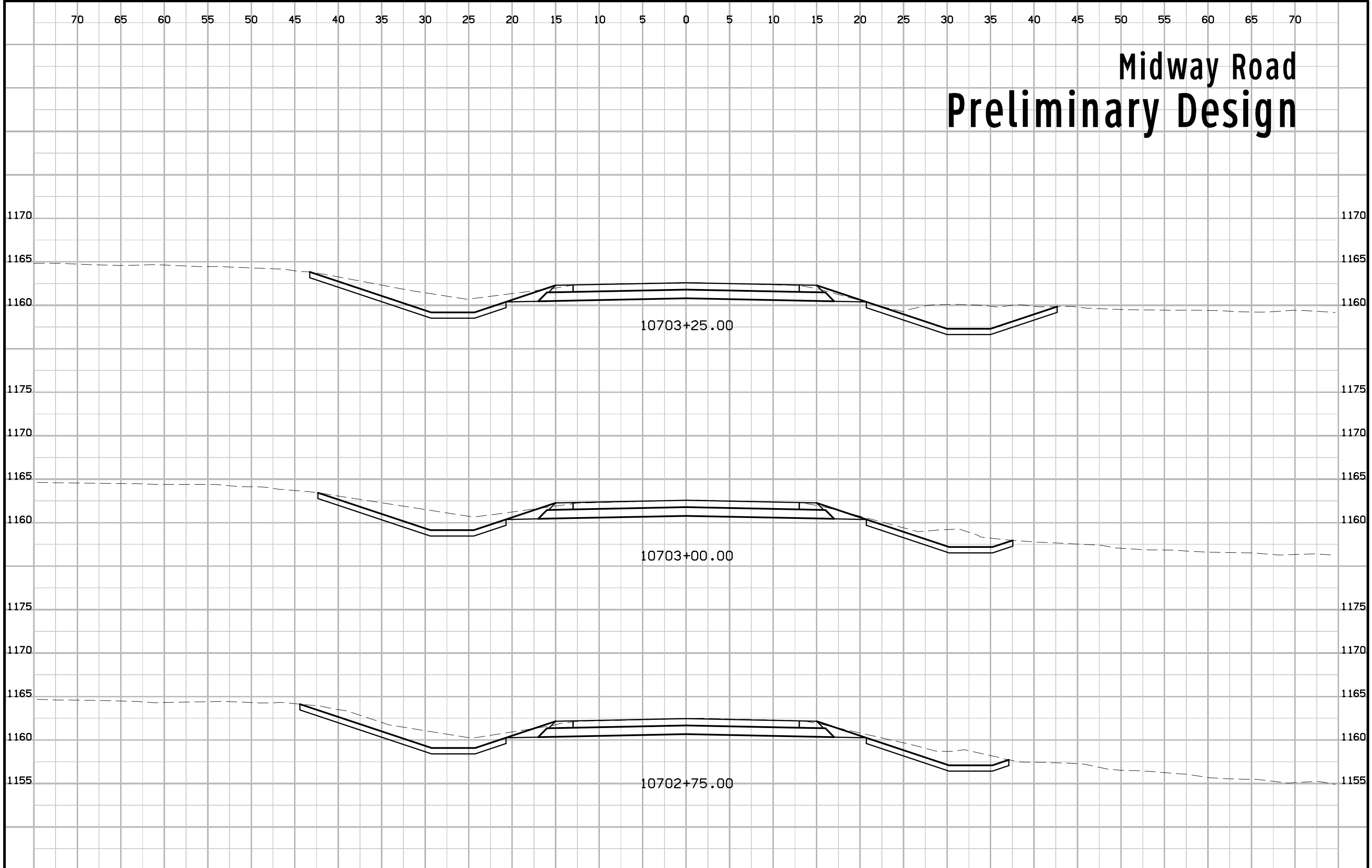

# Midway Road Preliminary Design

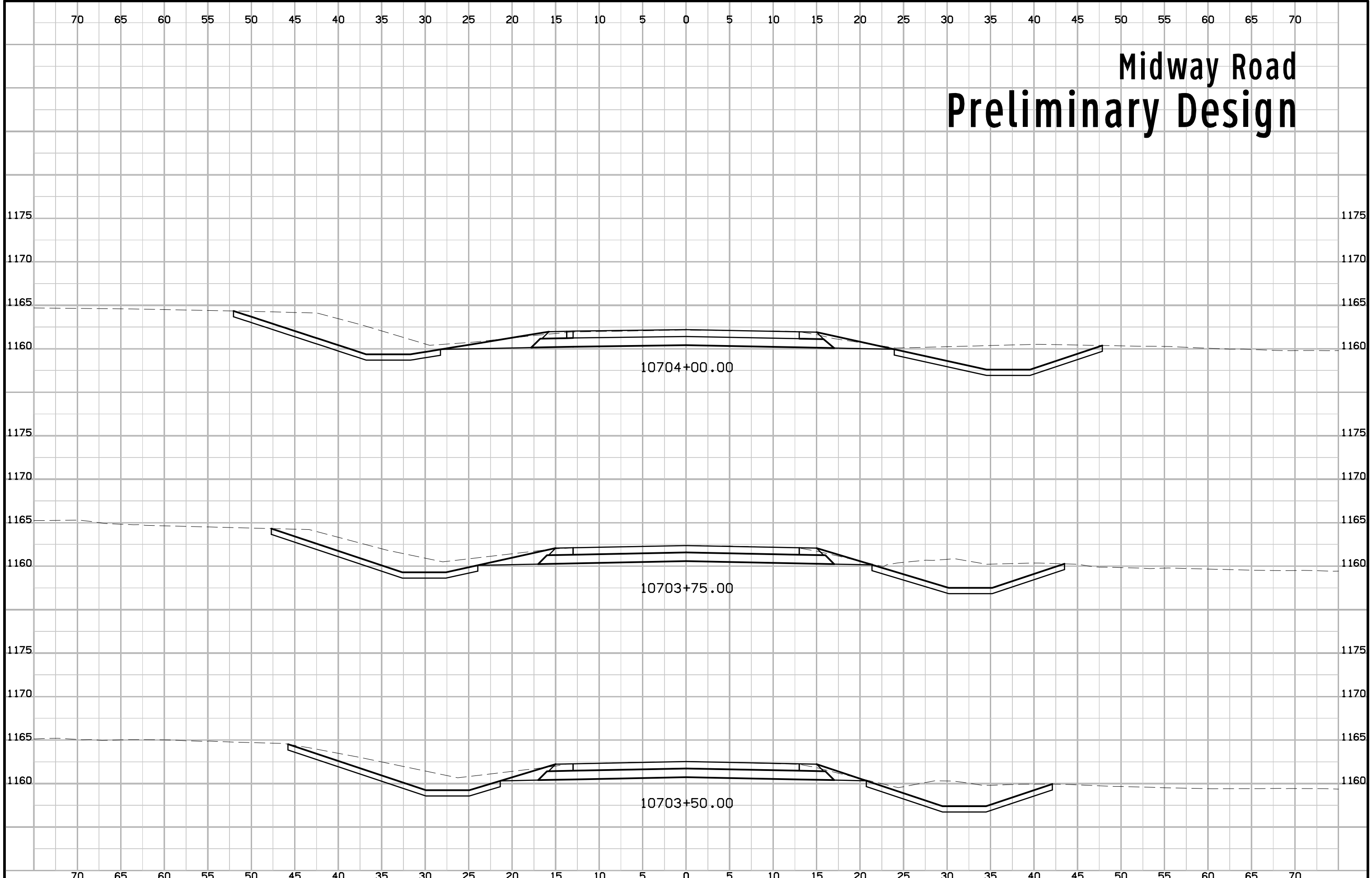

# Midway Road Preliminary Design

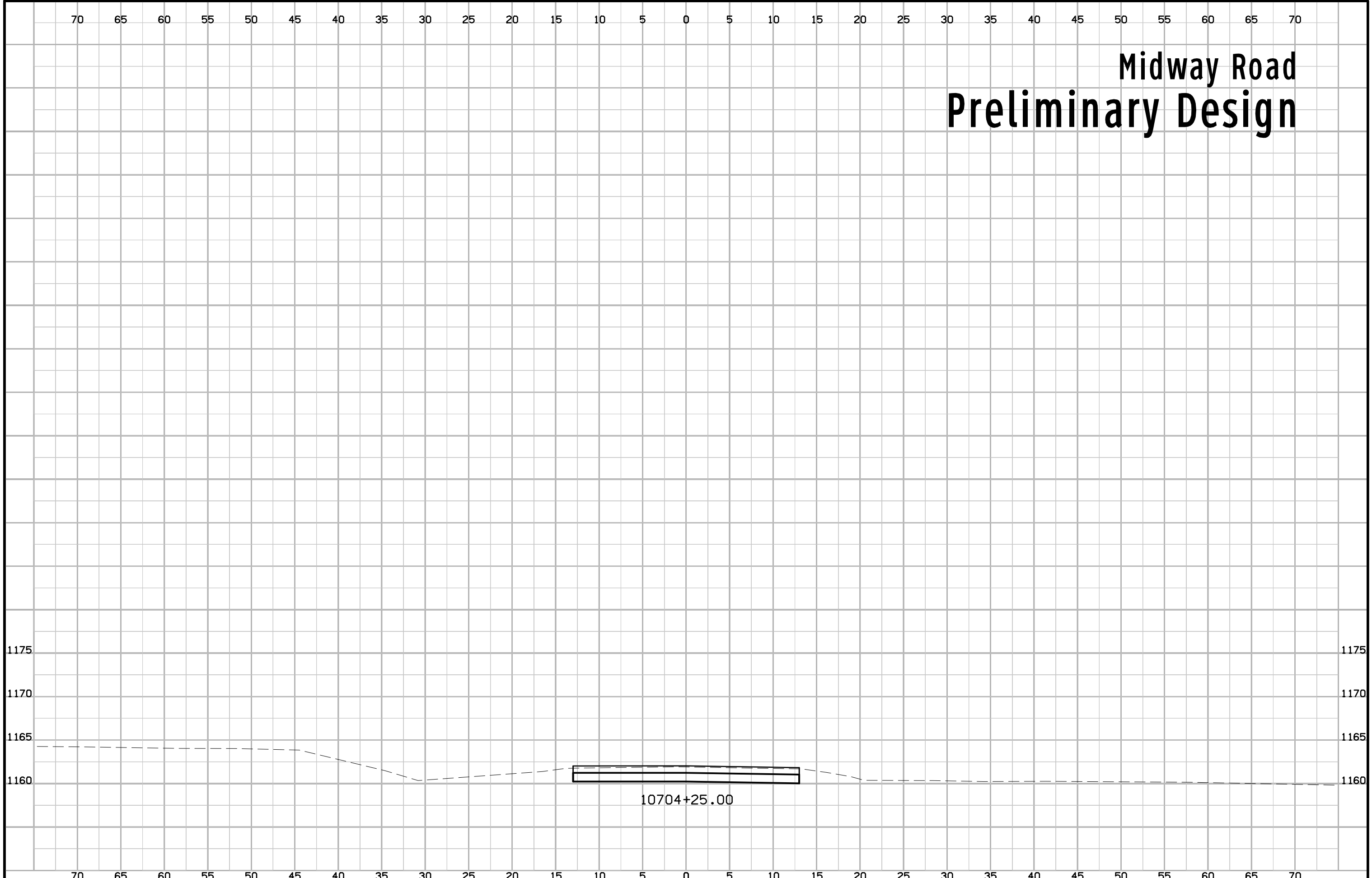

# Bankston Park Road Preliminary Design

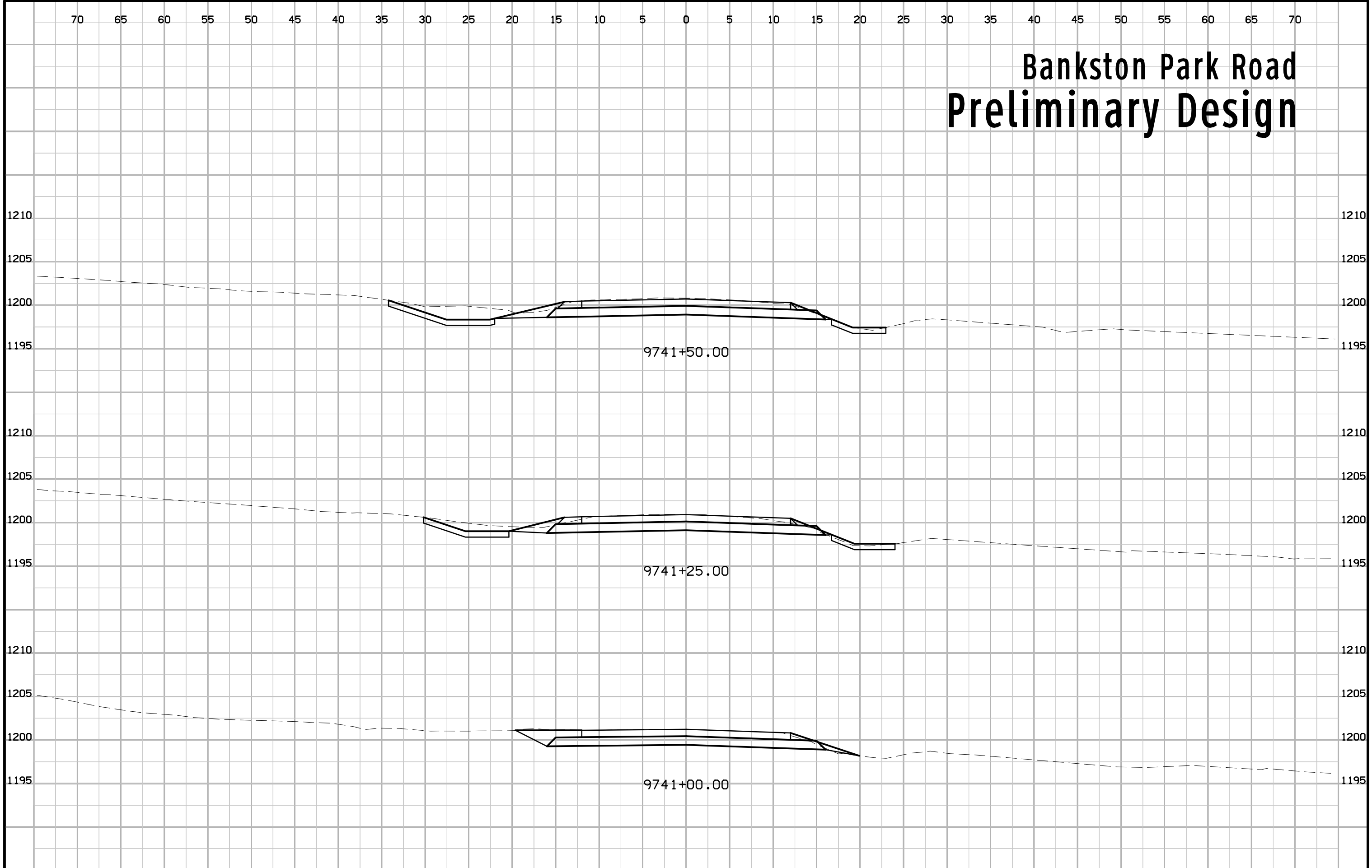

# Bankston Park Road Preliminary Design

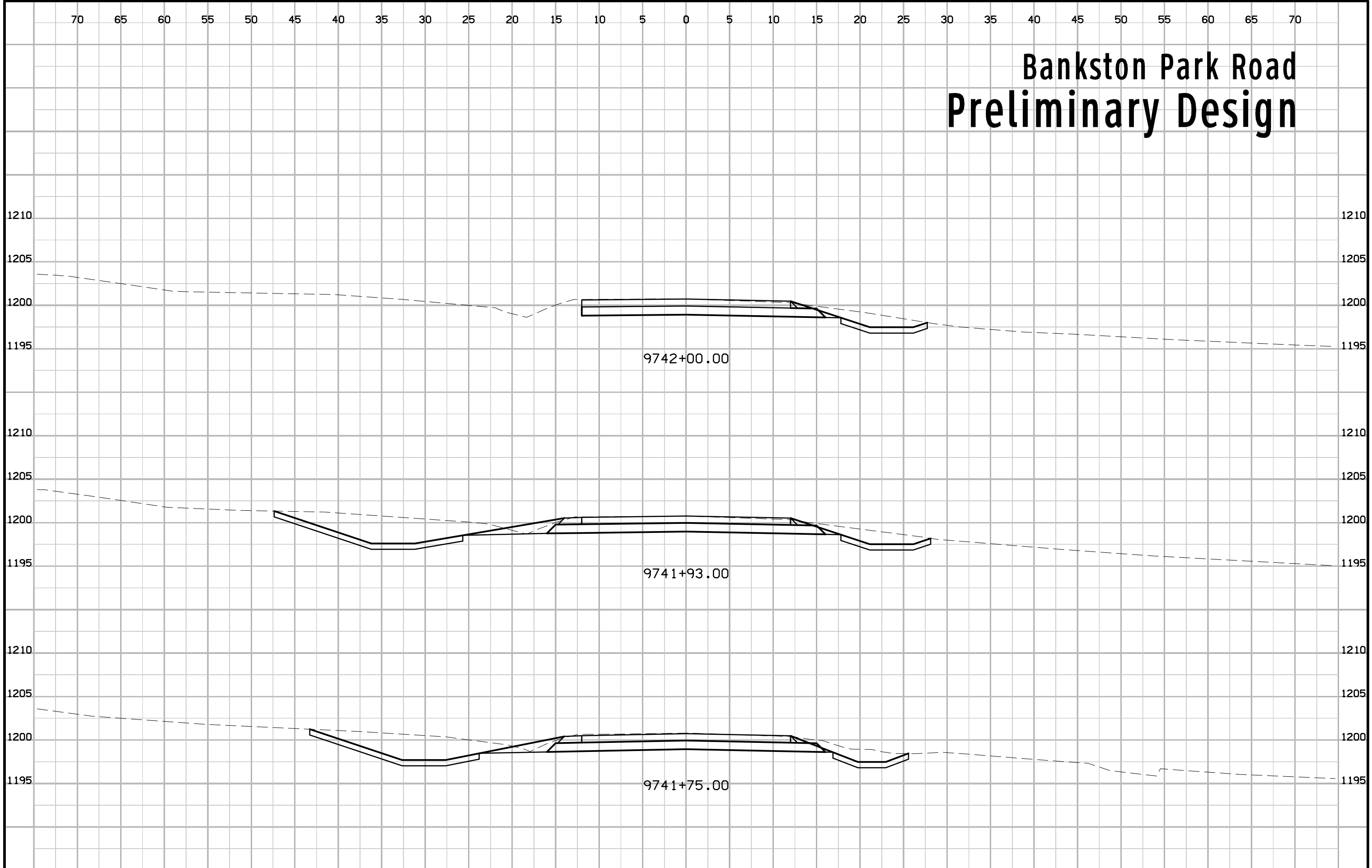

# Bankston Park Road Preliminary Design

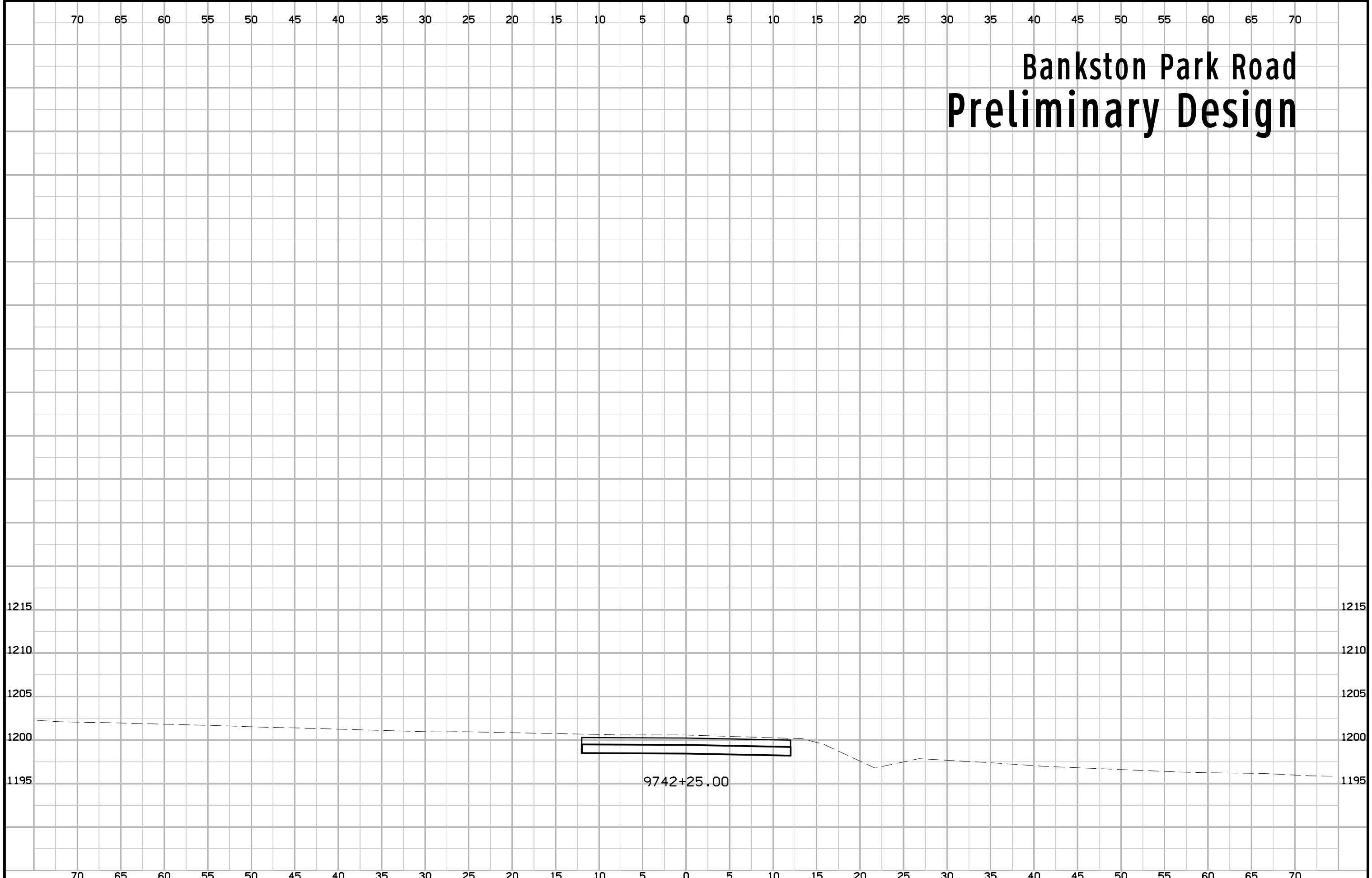

9742+25.00



# SR Pfeiler Road W Preliminary

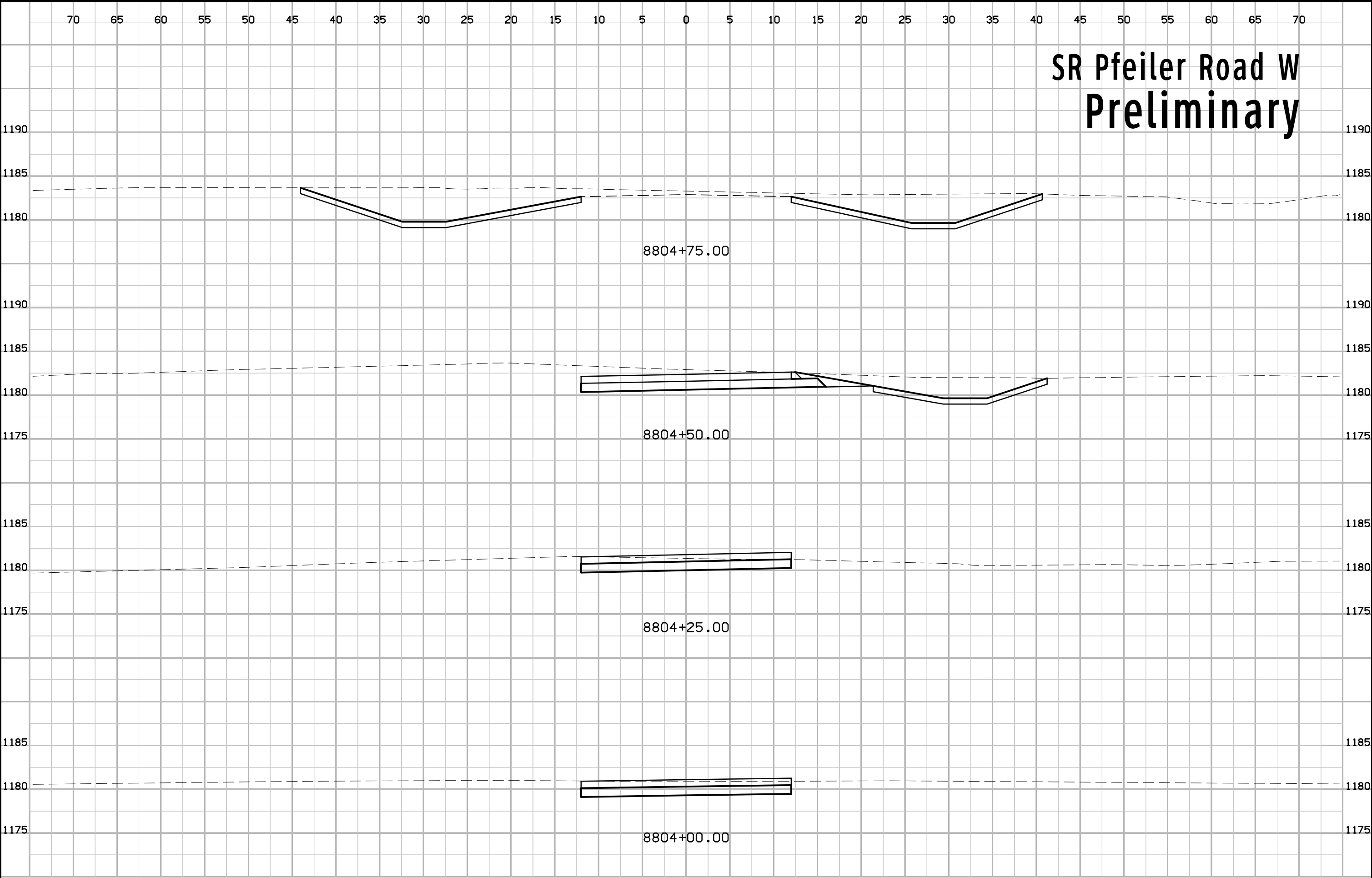

# SR Pfeiler Road W Preliminary

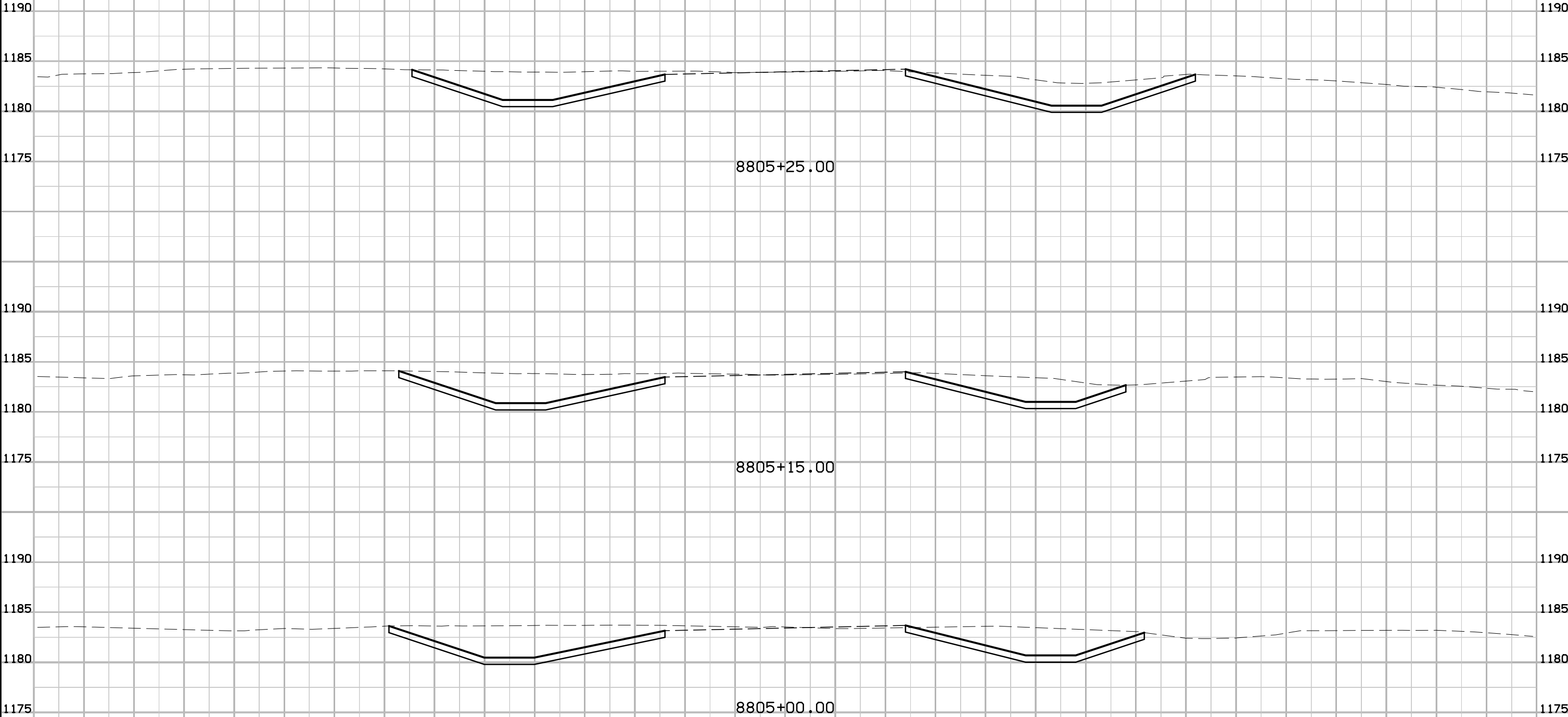

# SR Pfeiler Road W Preliminary

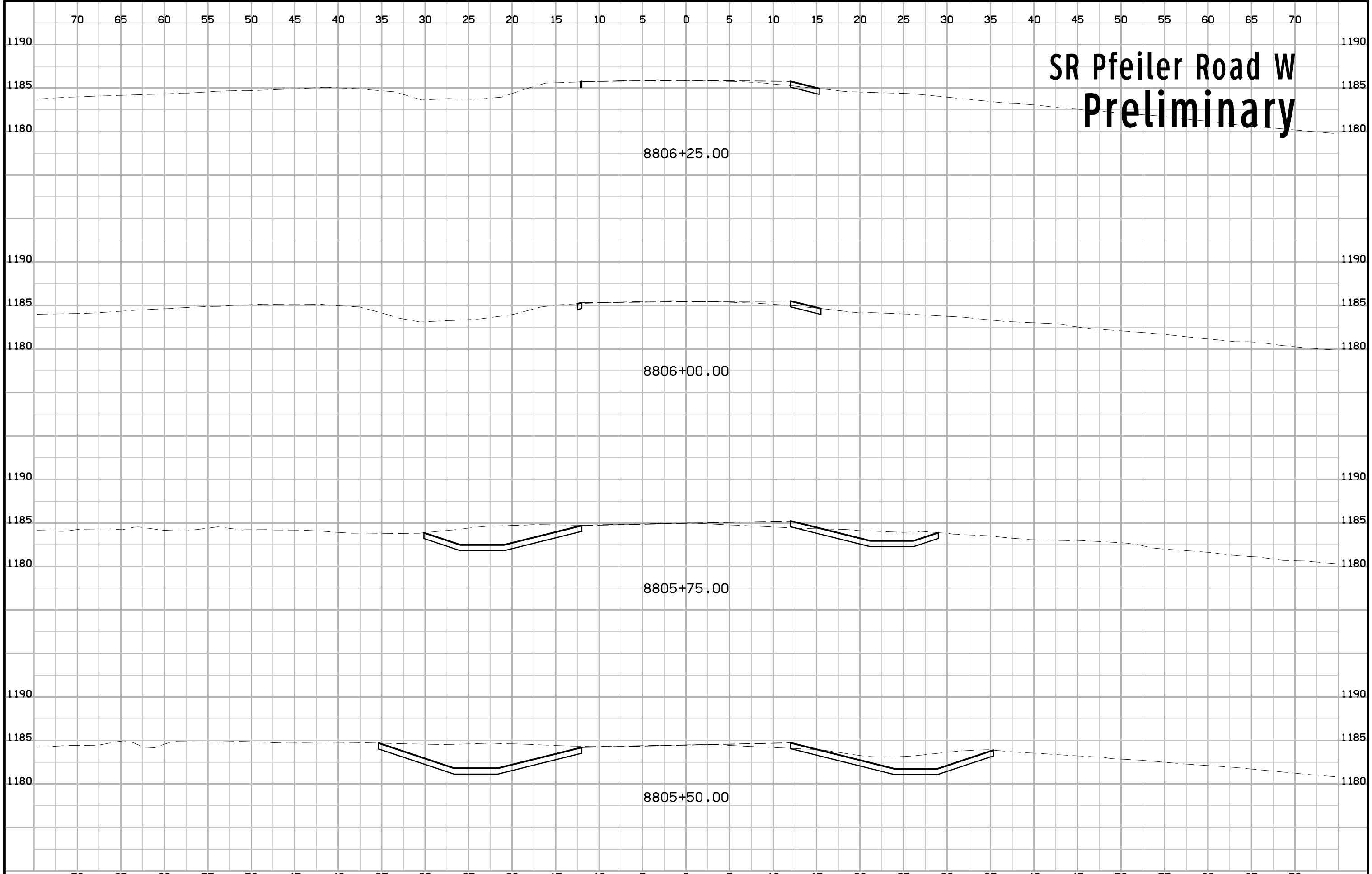

# SR Pfeiler Road W Preliminary

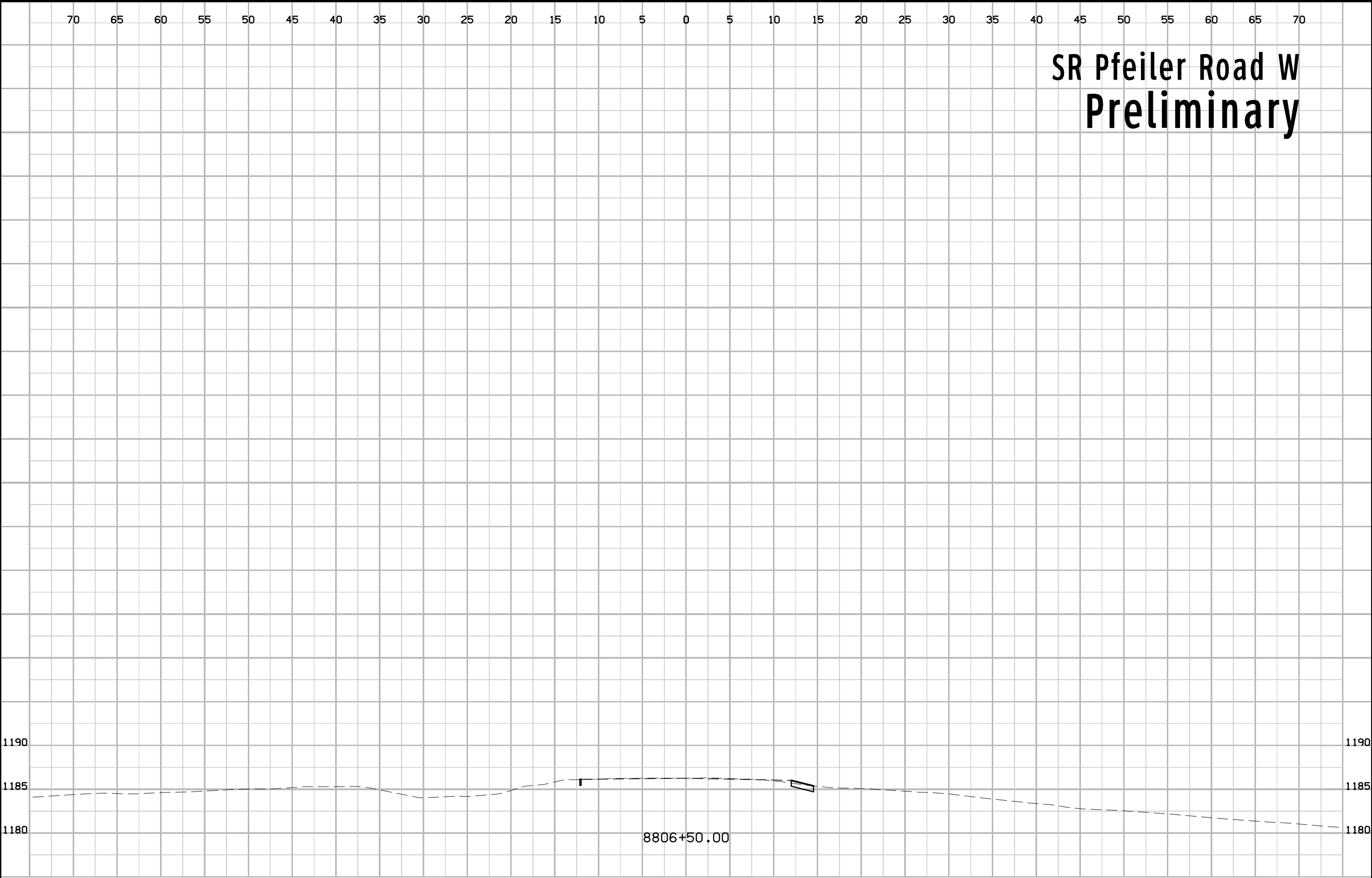

8806+50.00

# Schmitt Lane Preliminary

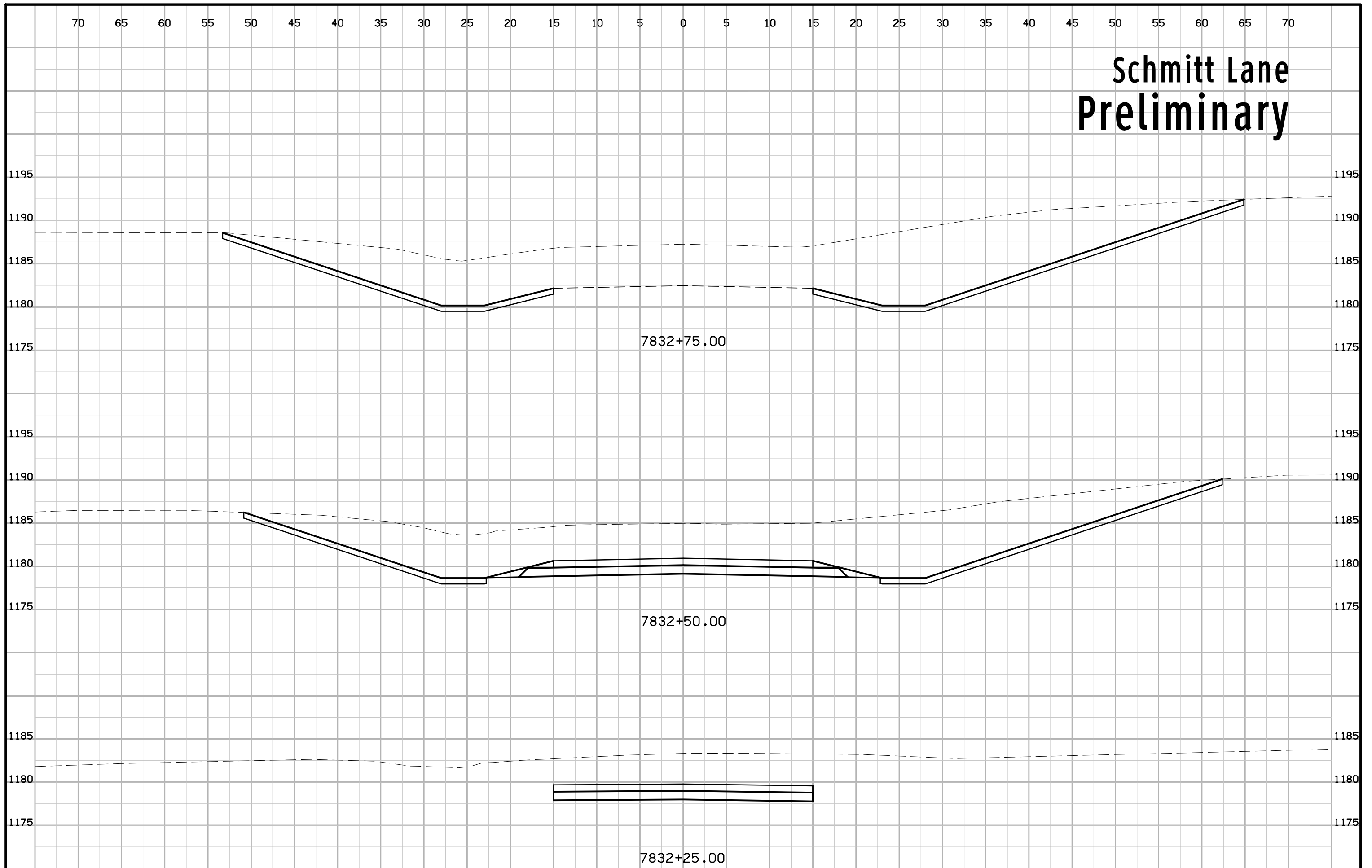

# Schmitt Lane Preliminary

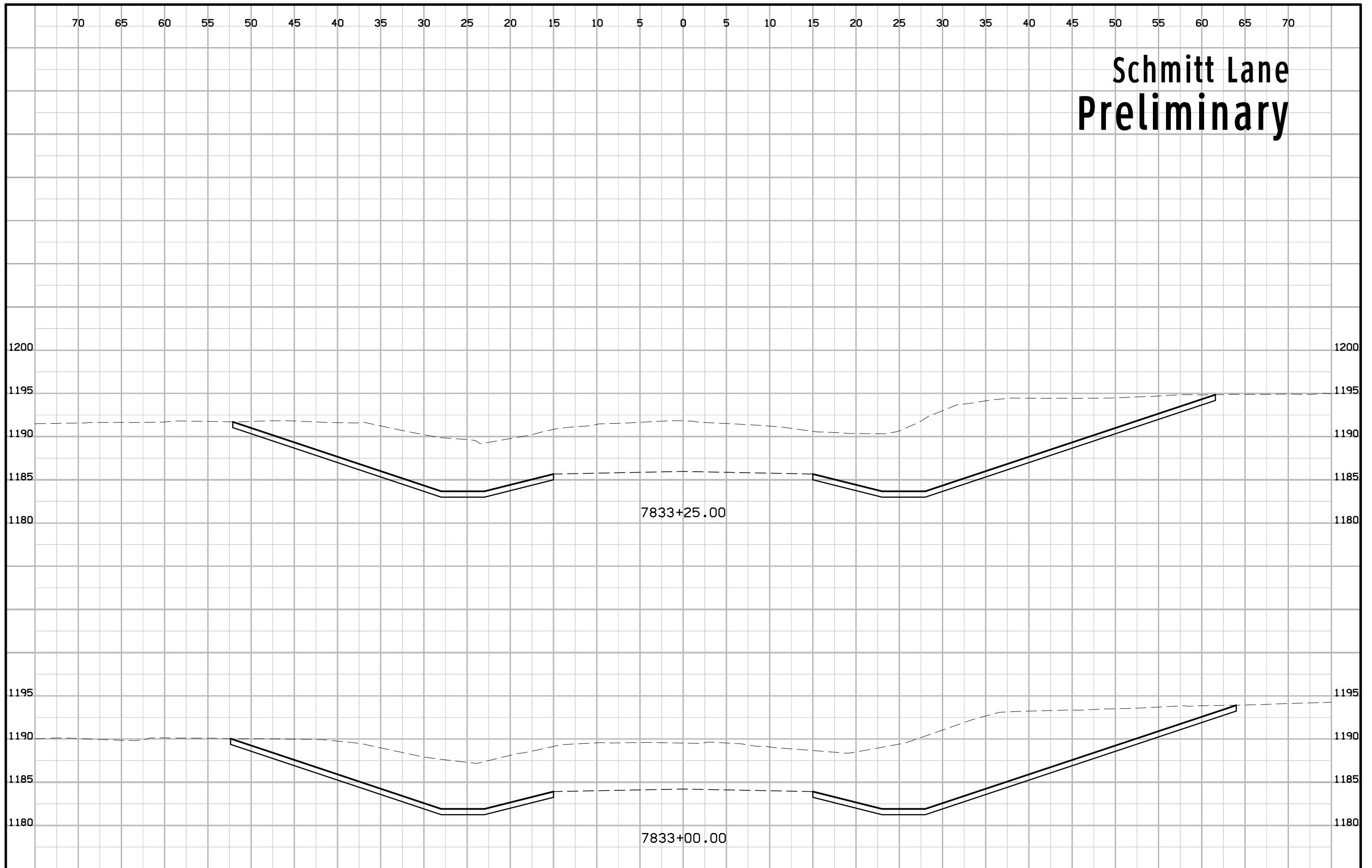

# Schmitt Lane Preliminary

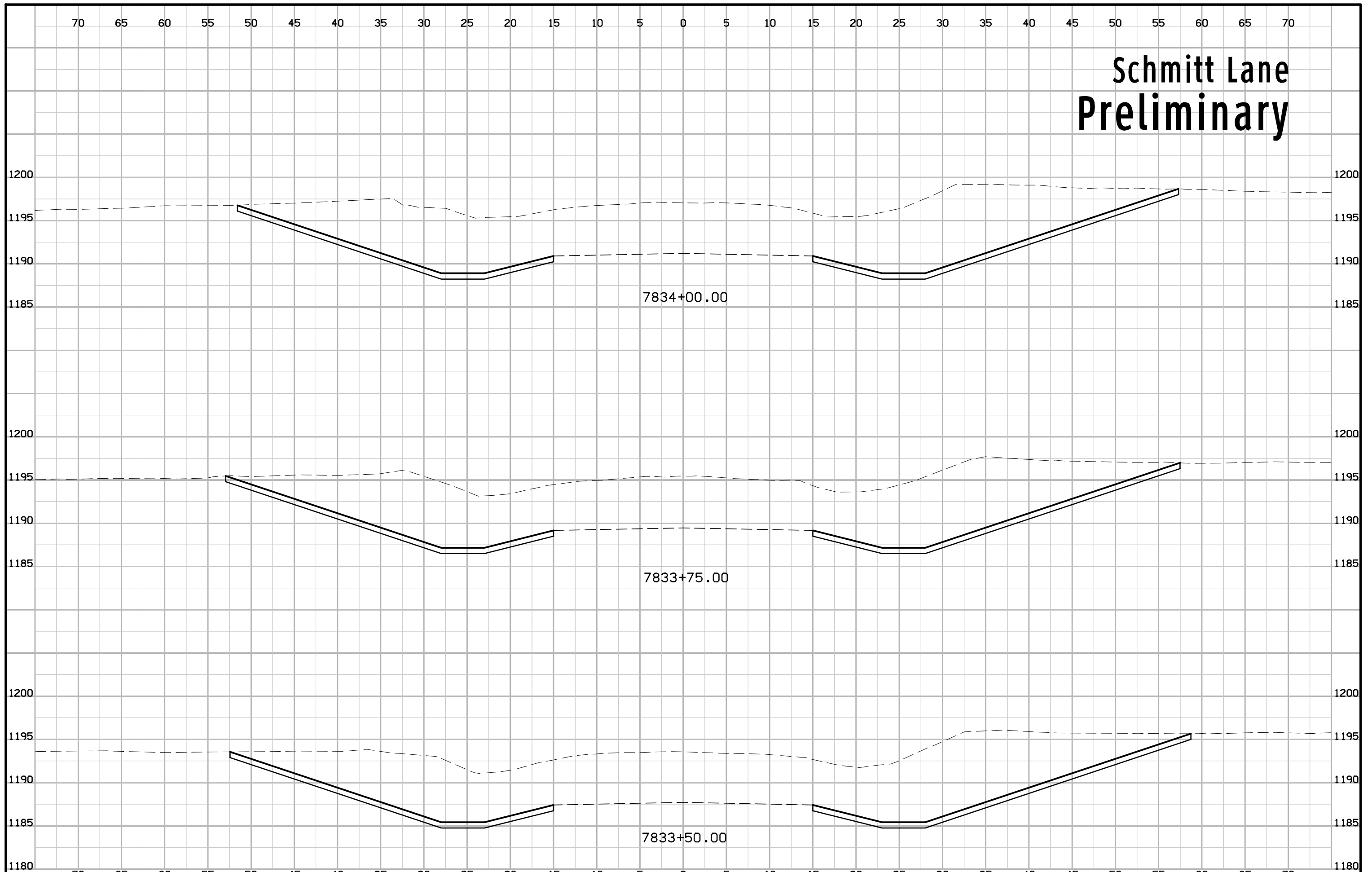

# Schmitt Lane Preliminary

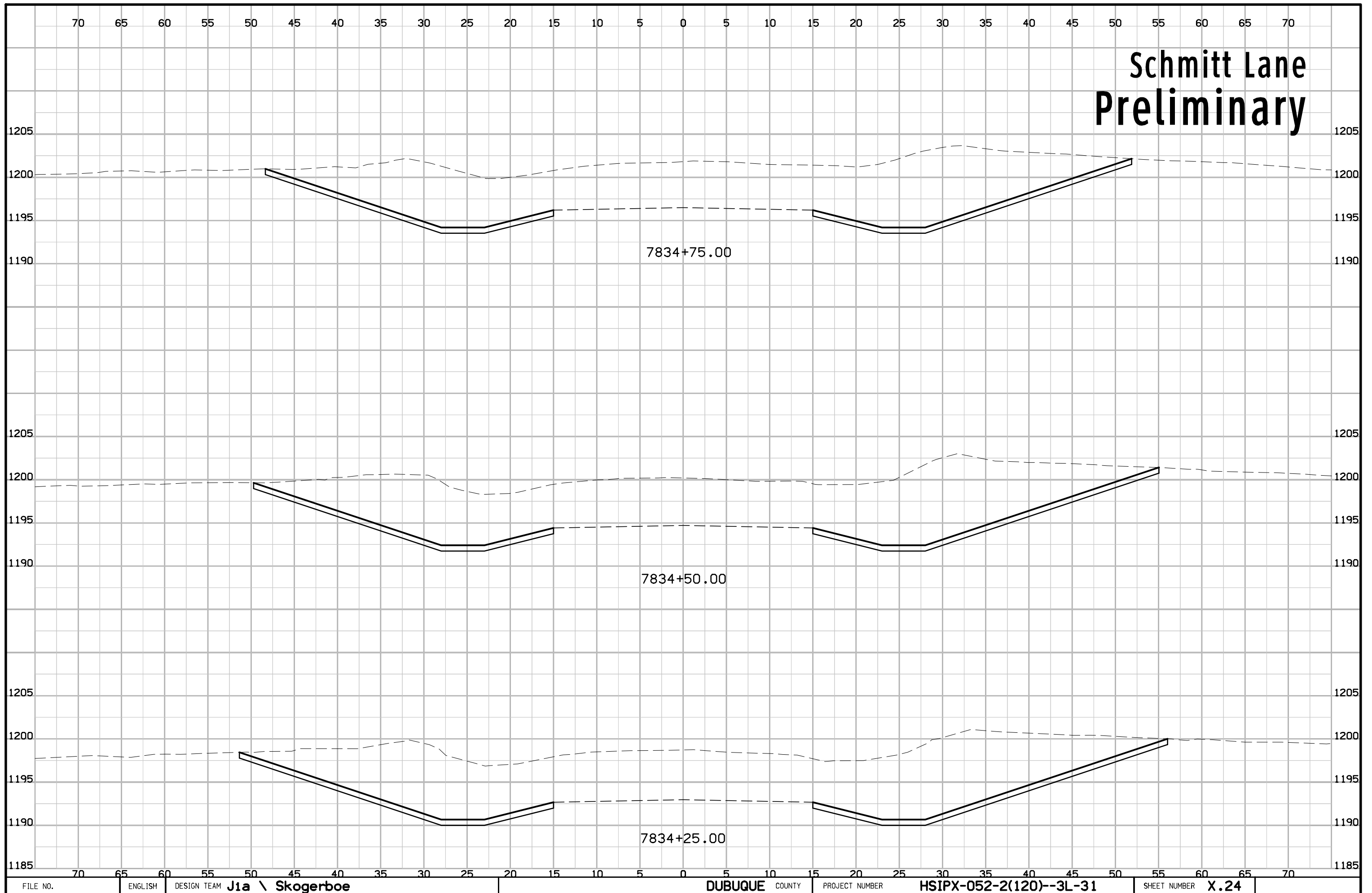



# Schmitt Lane Preliminary

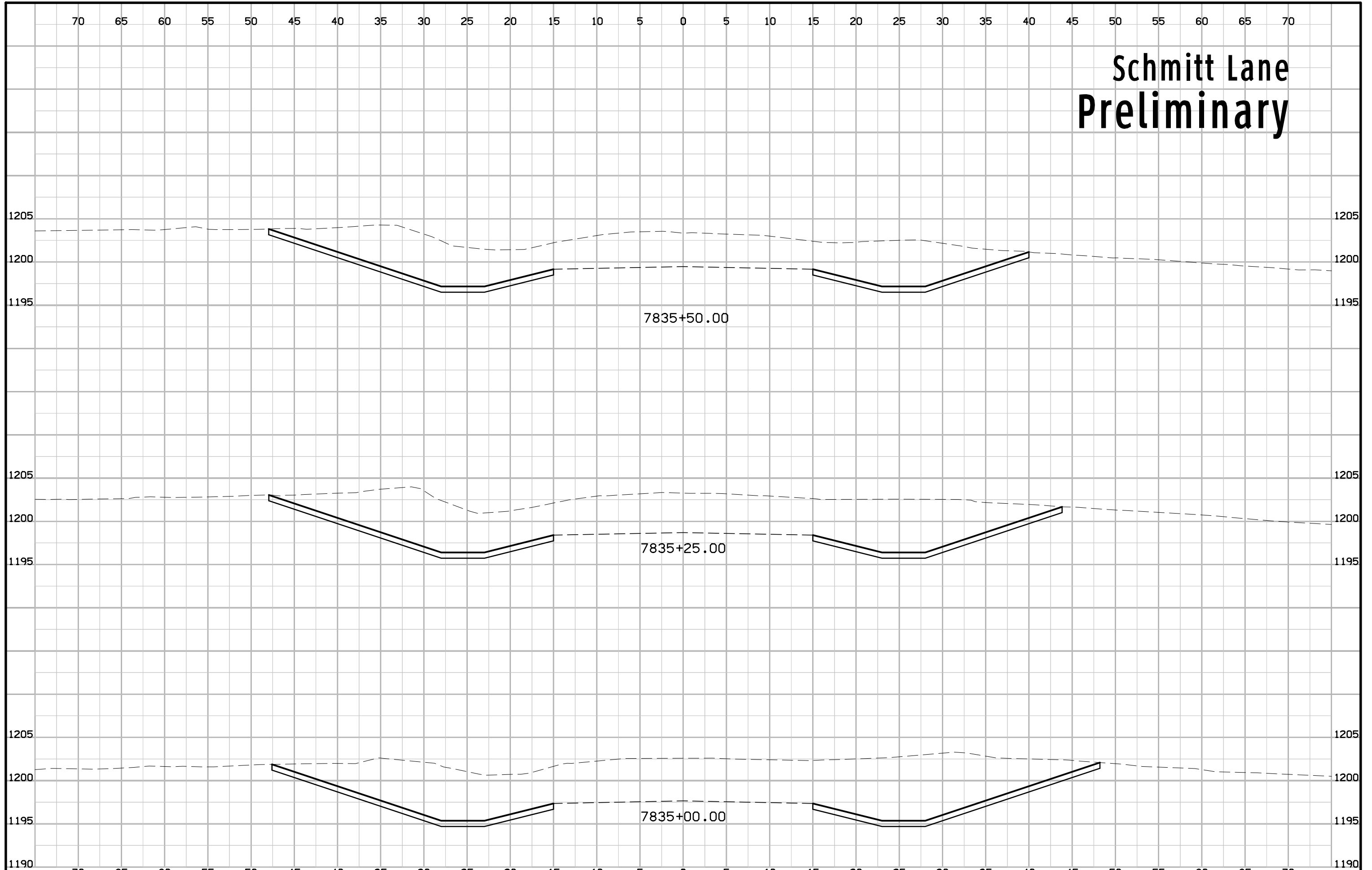

# Schmitt Lane Preliminary

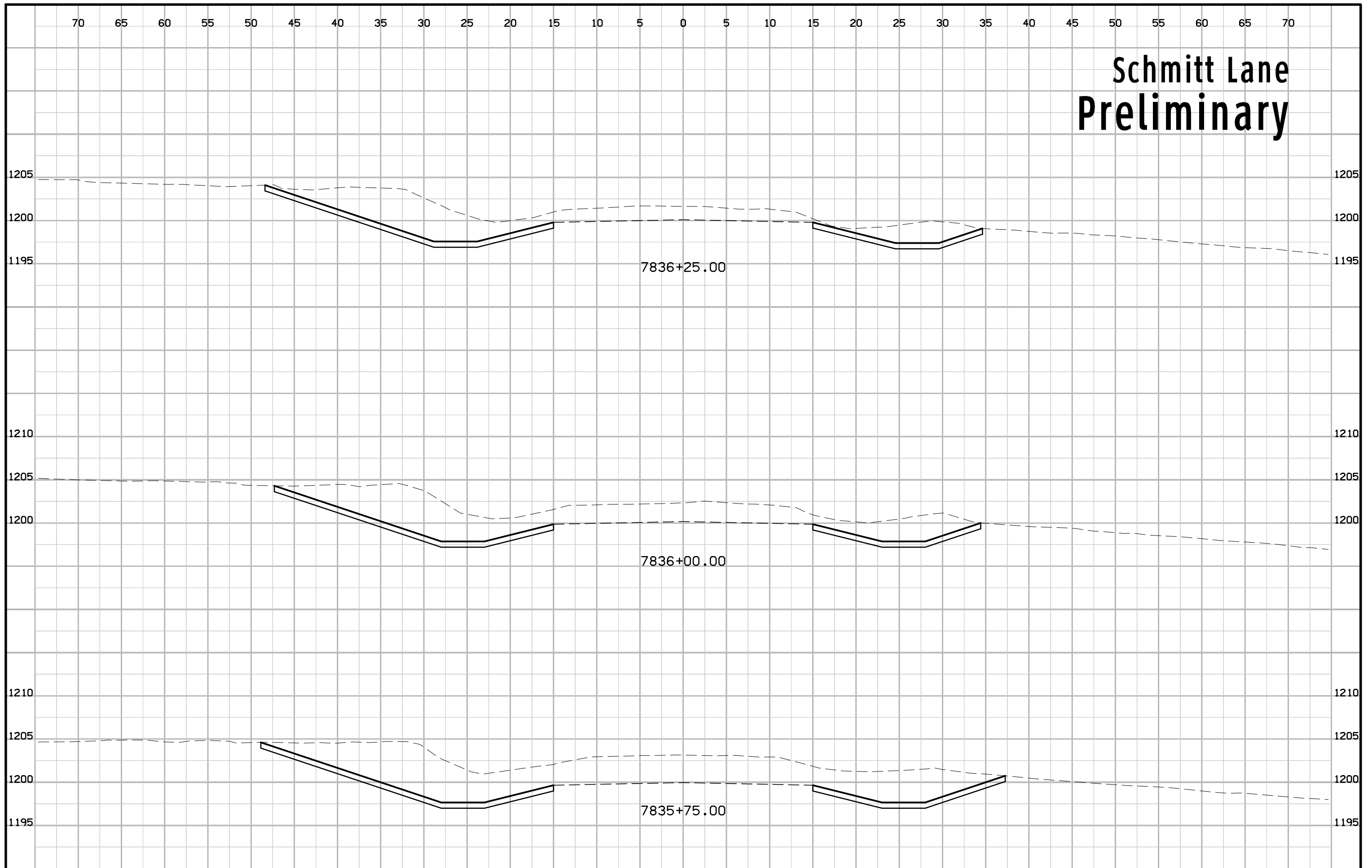

# Schmitt Lane Preliminary

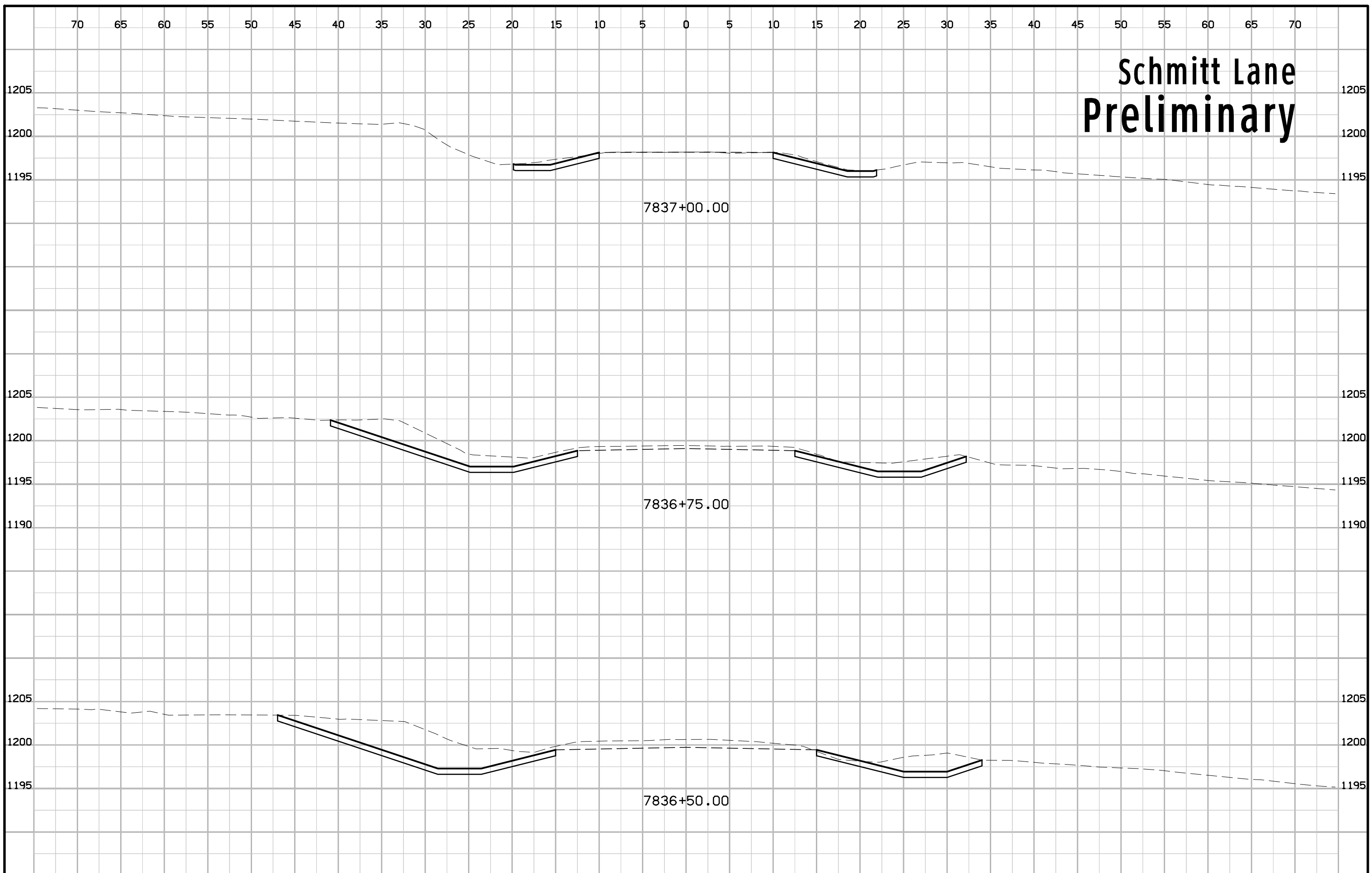

# Roundabout Circulator Lane US 52 Preliminary

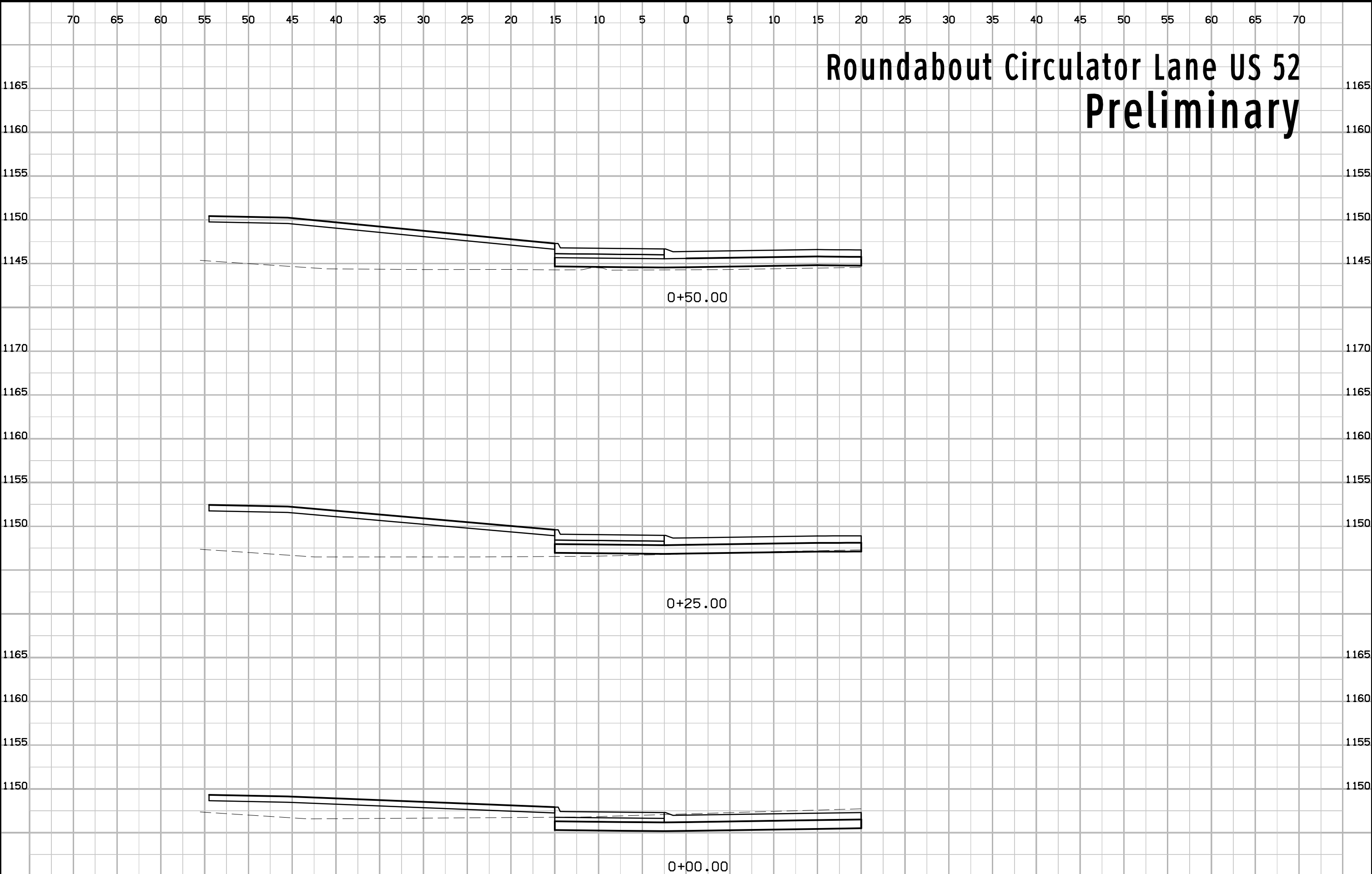

# Roundabout Circulator Lane US 52 Preliminary

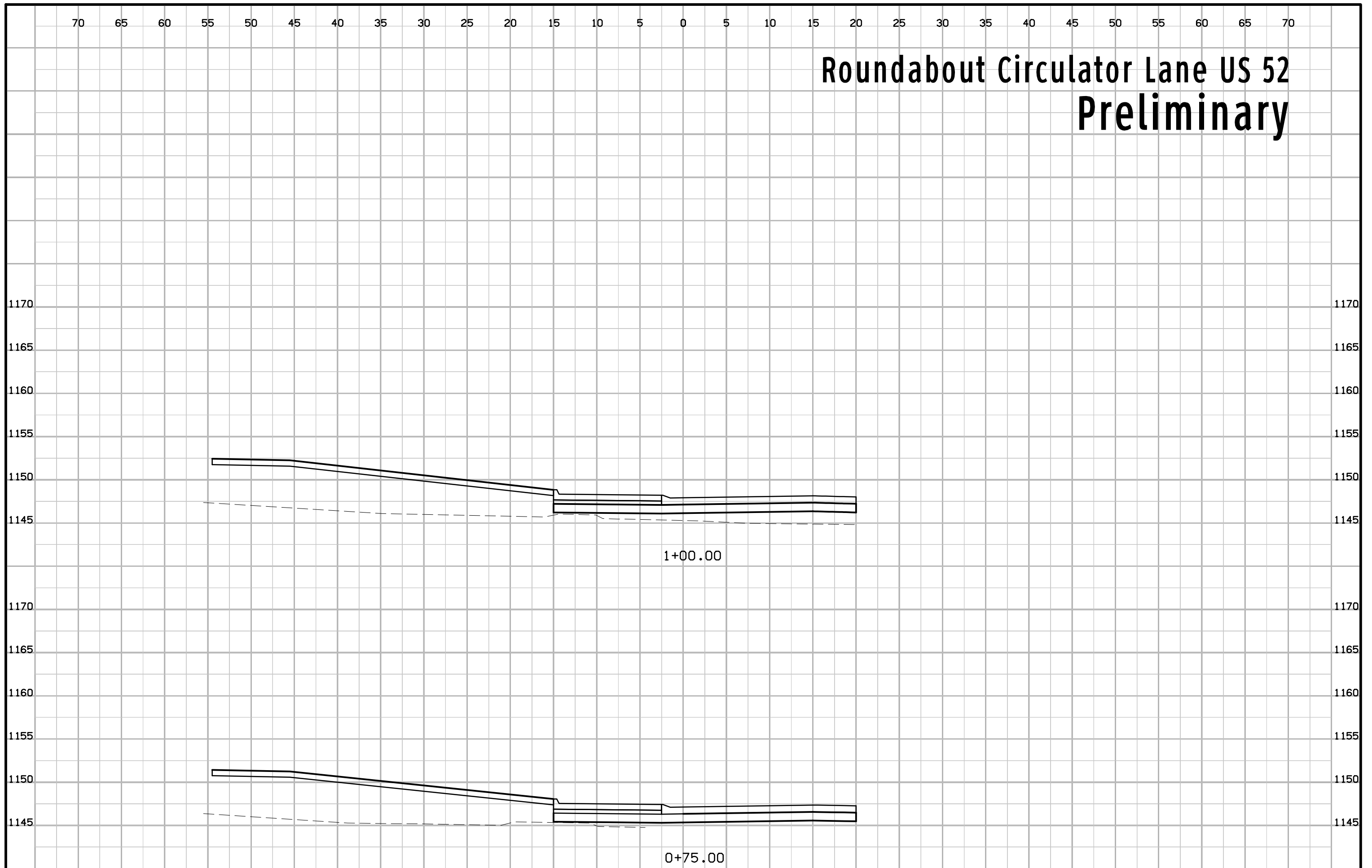

# Roundabout Circulator Lane US 52 Preliminary

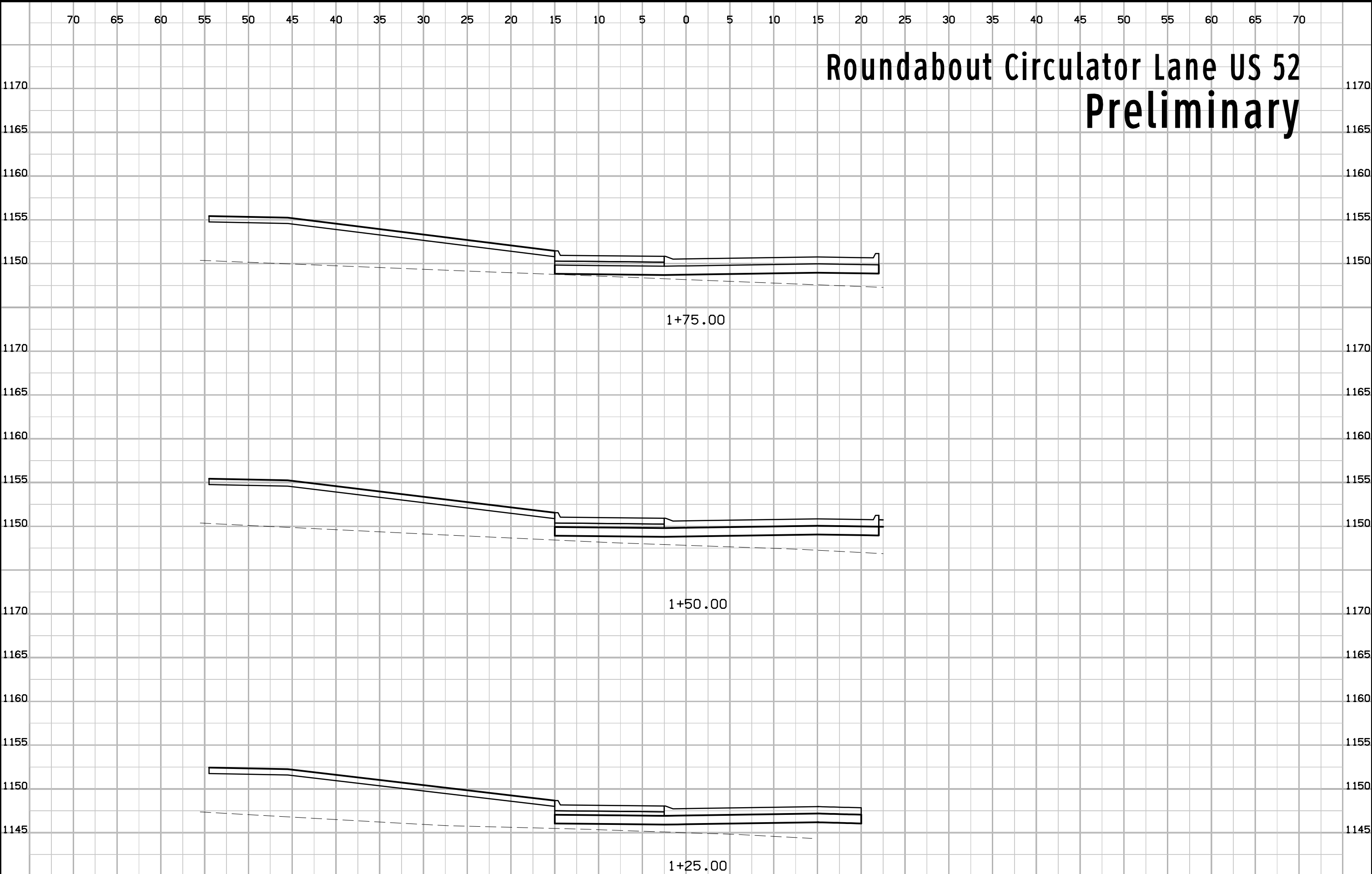

# Roundabout Circulator Lane US 52 Preliminary

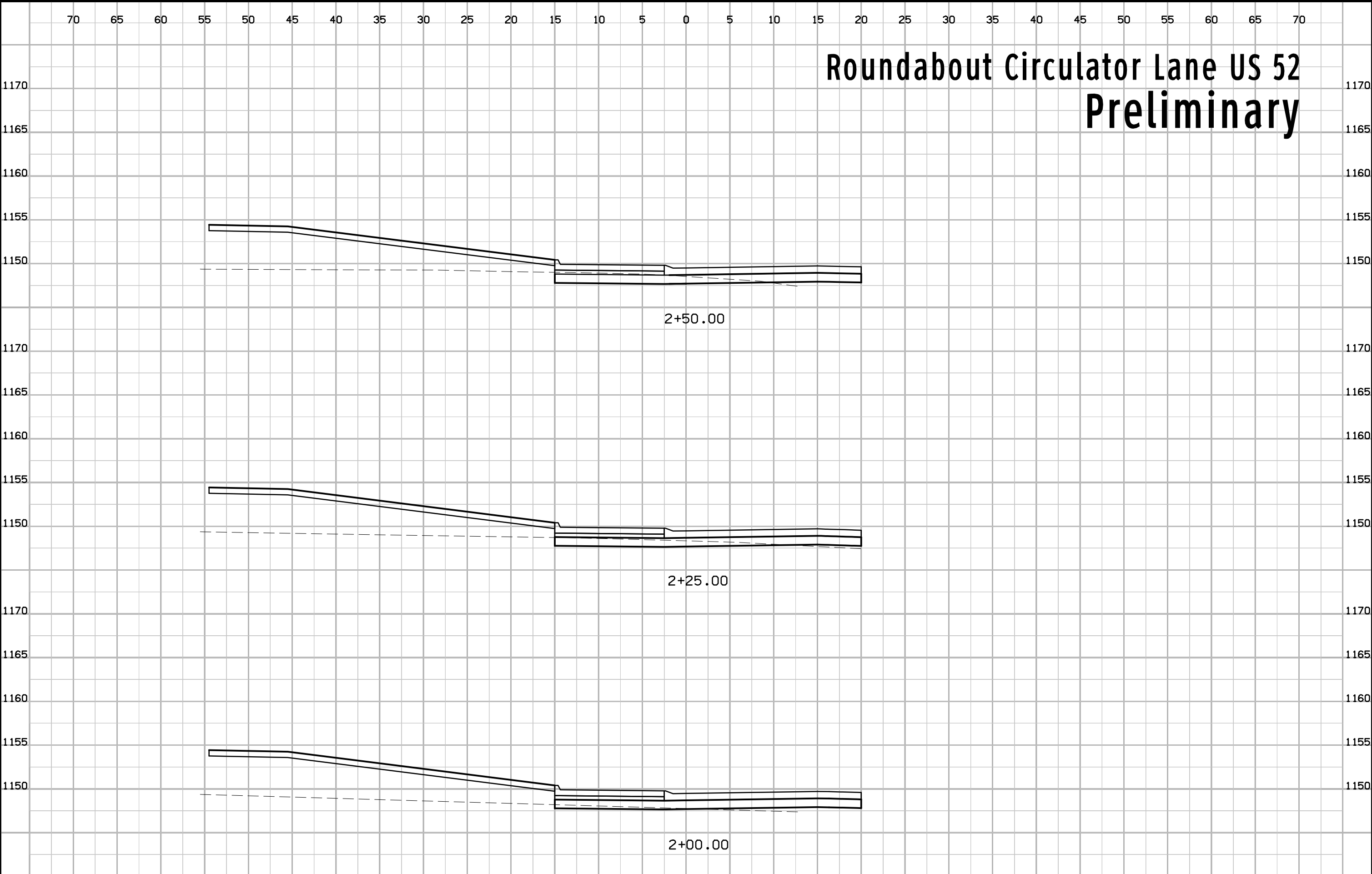

# Roundabout Circulator Lane US 52 Preliminary

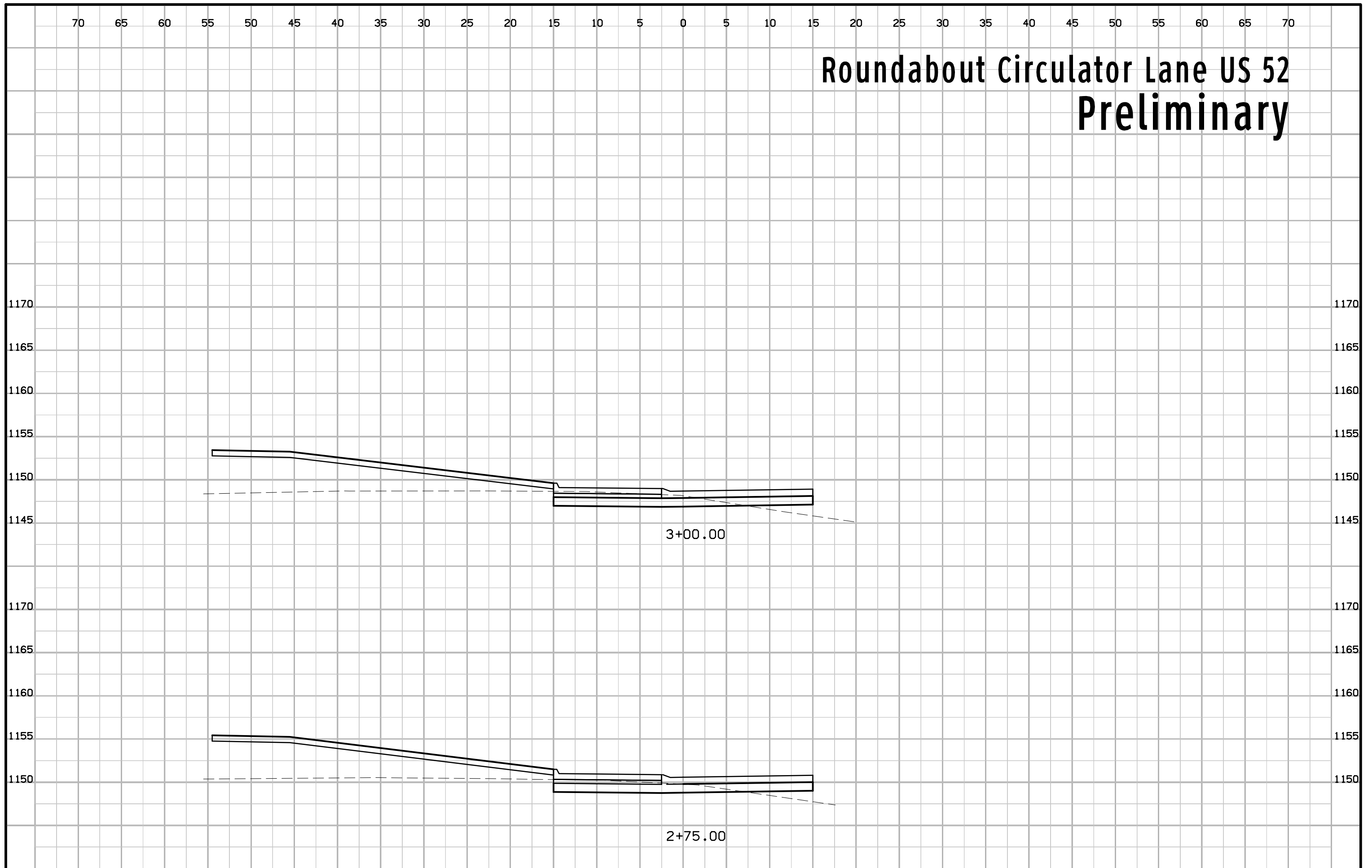



# Roundabout WB US 52 Preliminary

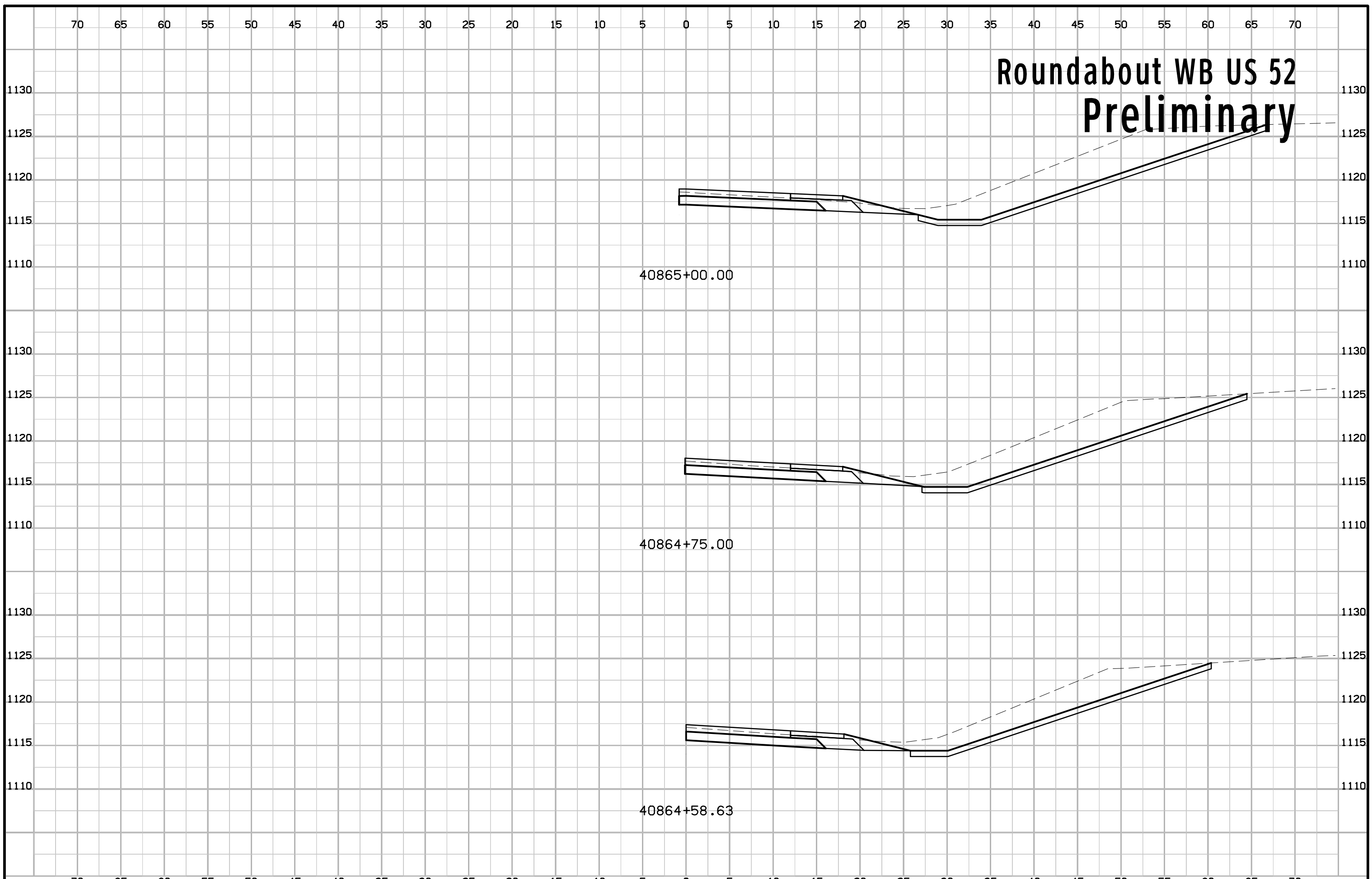

# Roundabout WB US 52 Preliminary

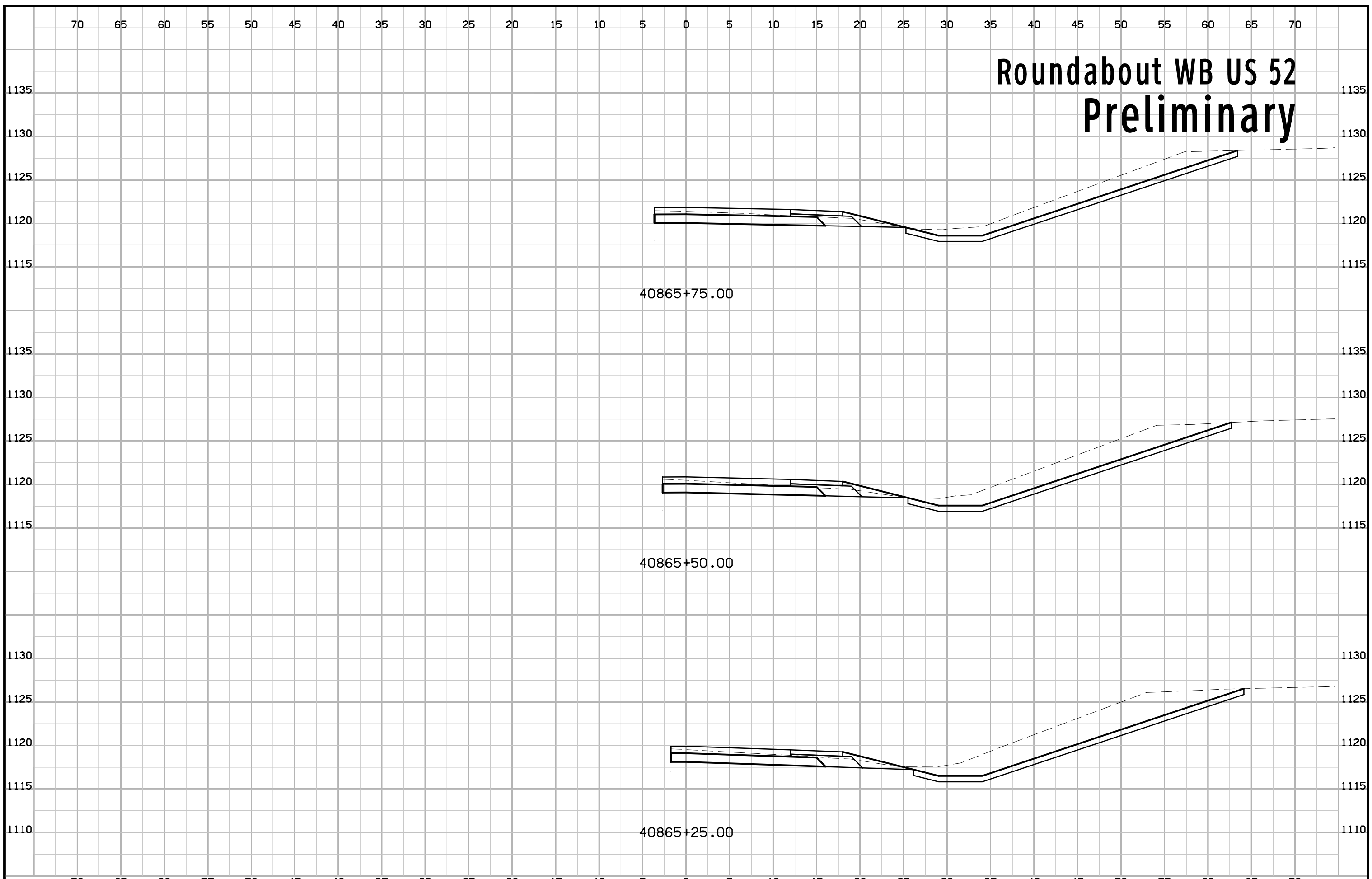

# Roundabout WB US 52 Preliminary

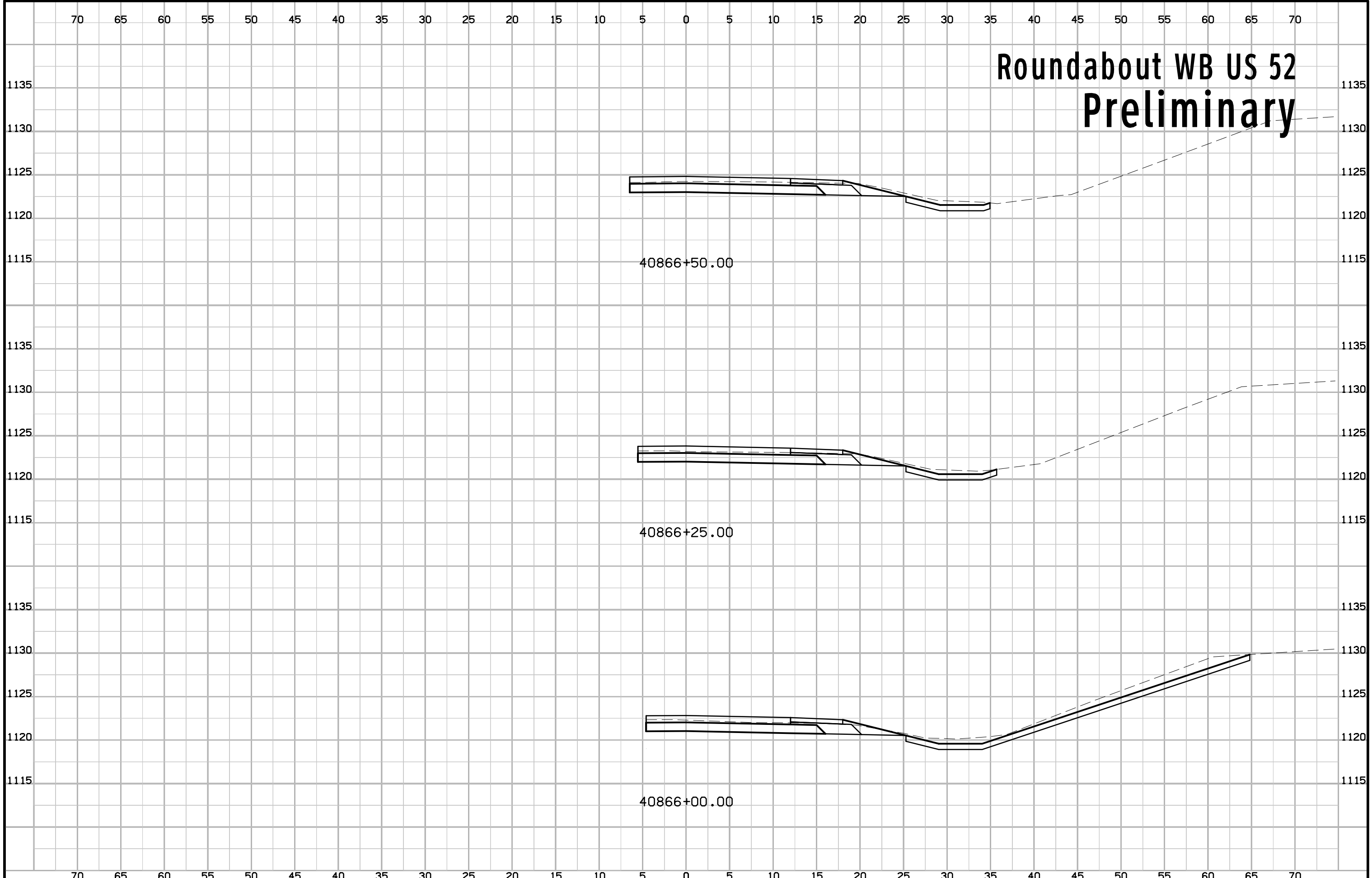

# Roundabout WB US 52 Preliminary

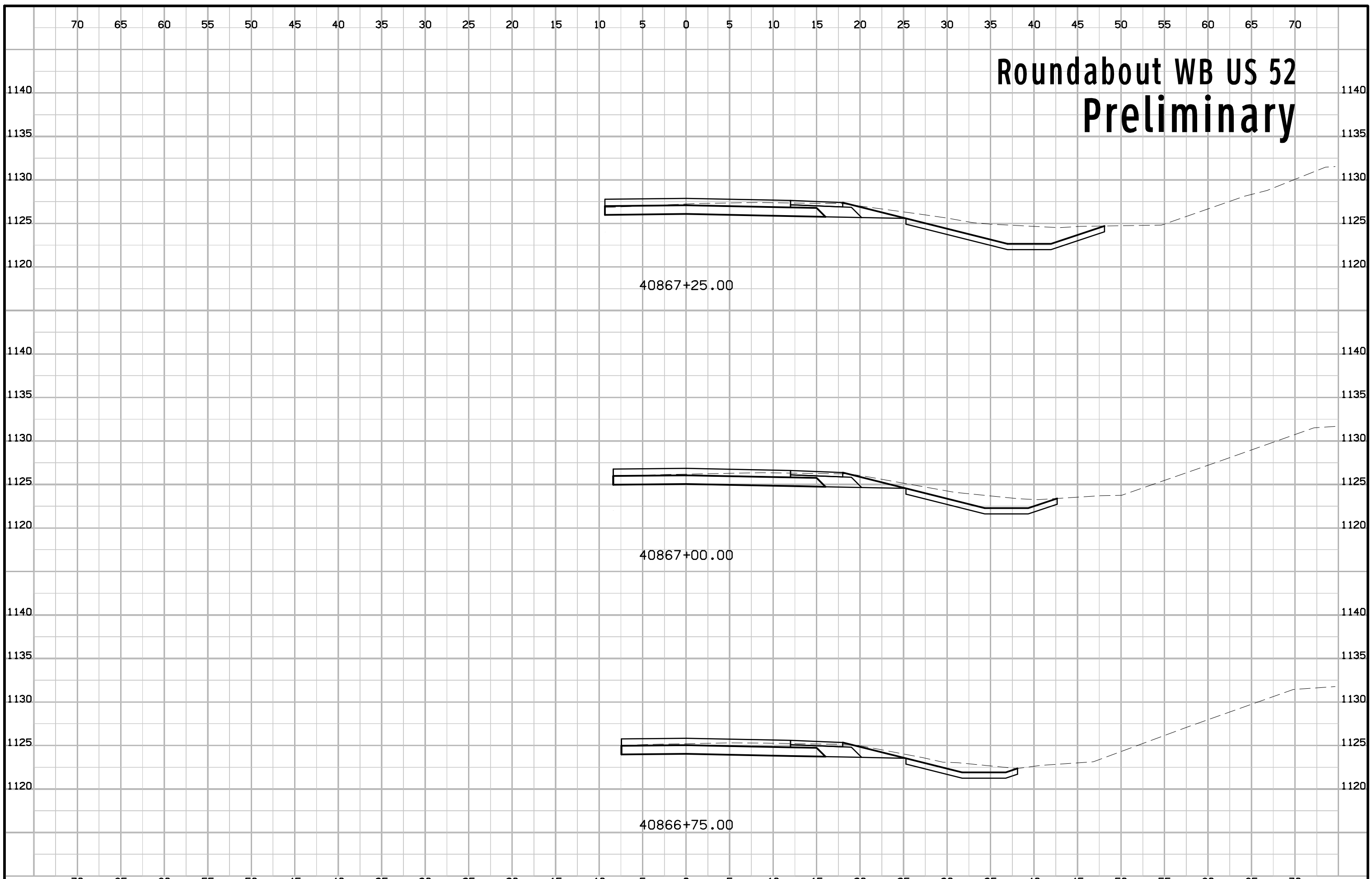

40867+25.00

40867+00.00

40866+75.00

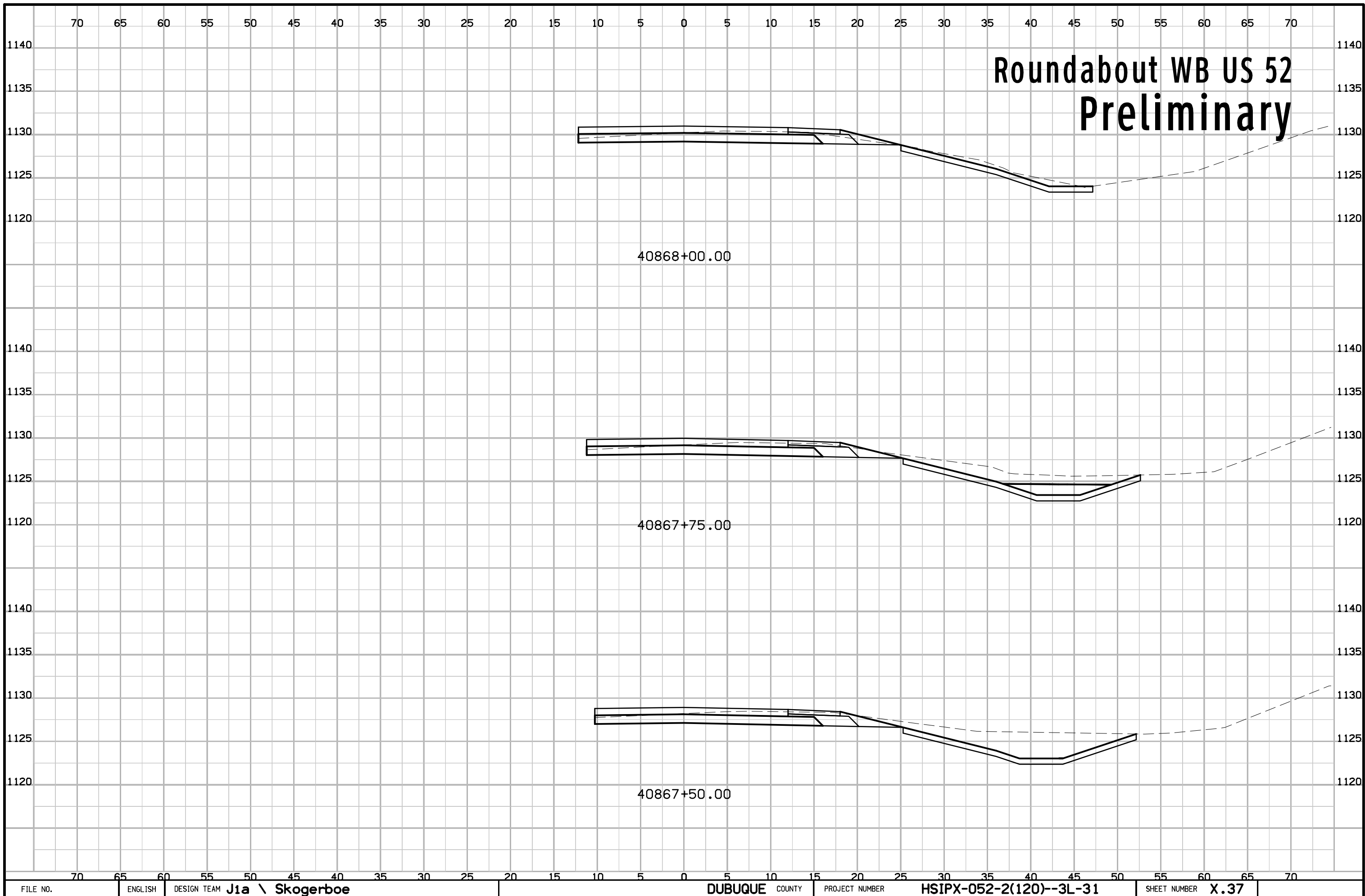

# Roundabout WB US 52 Preliminary

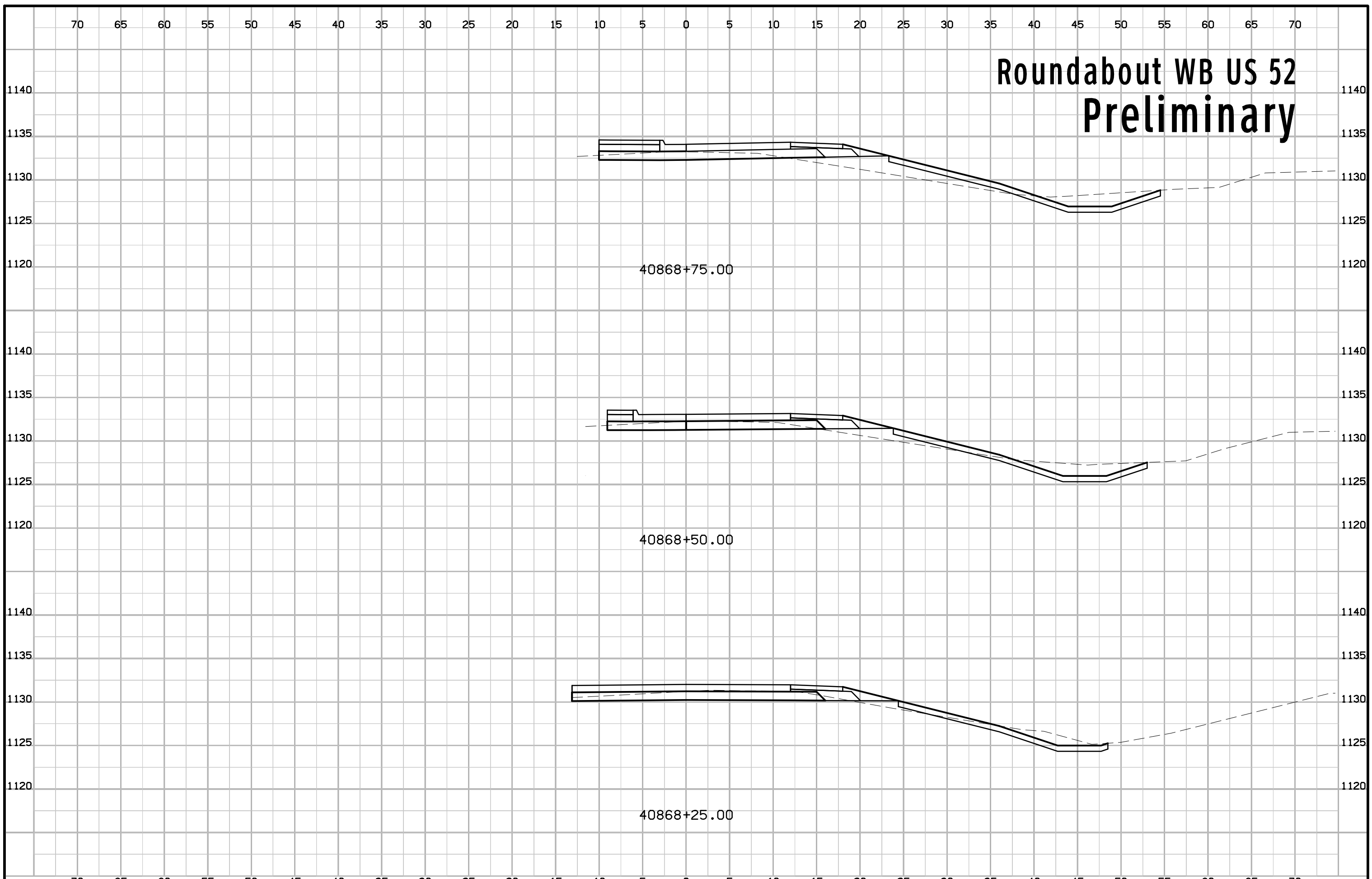

# Roundabout WB US 52 Preliminary

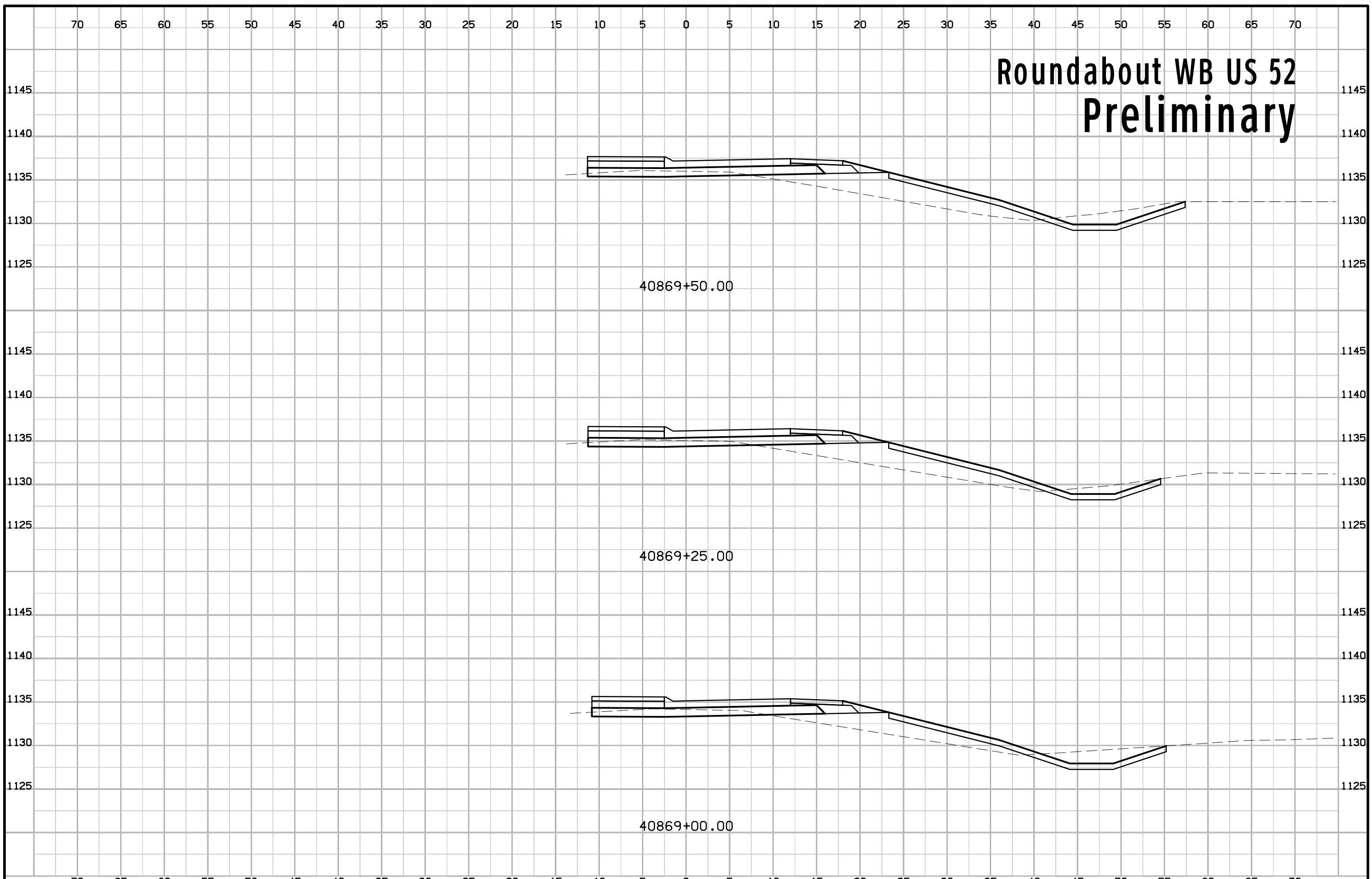

# Roundabout WB US 52 Preliminary

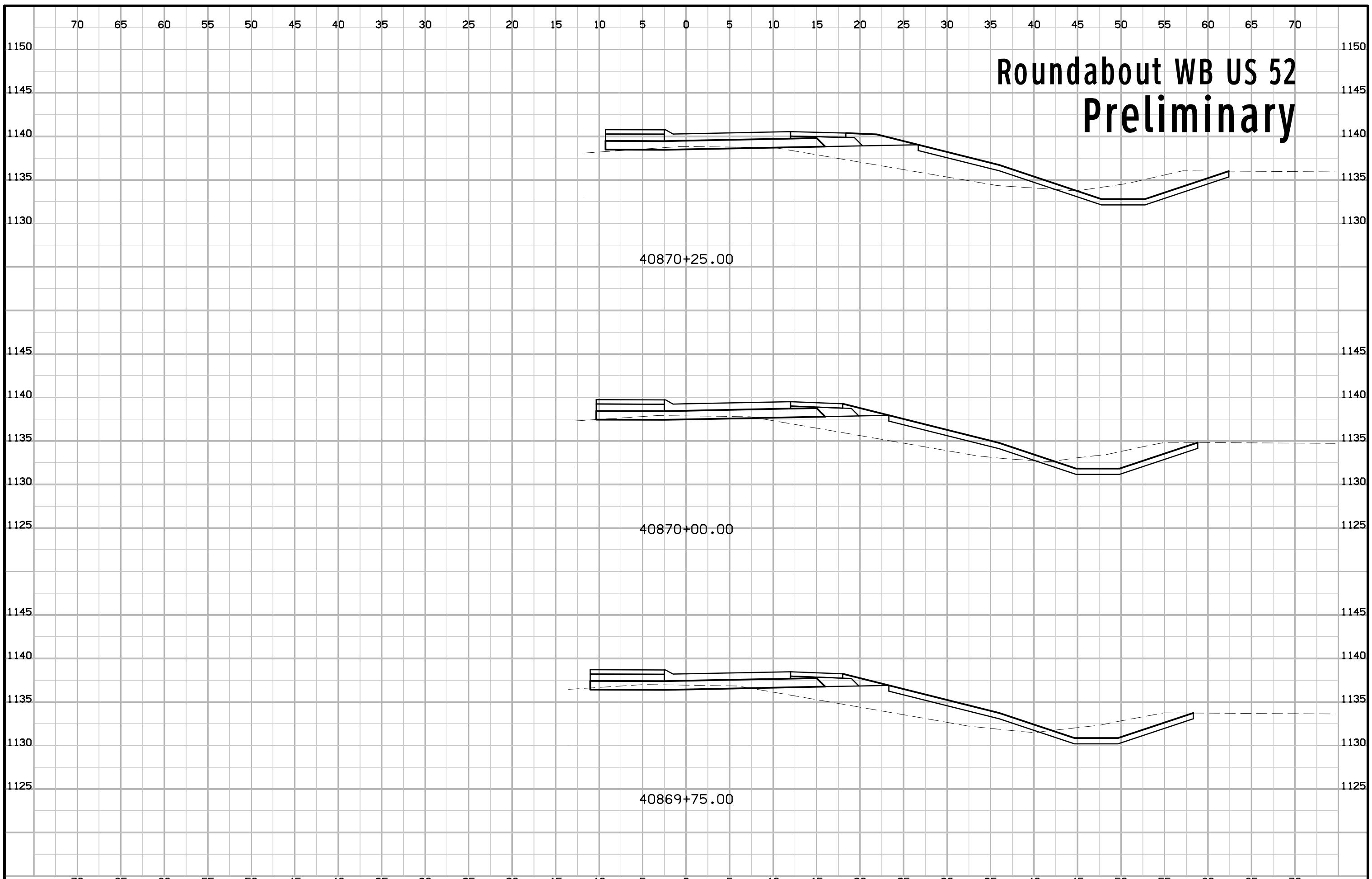

40870+25.00

40870+00.00

40869+75.00



# Roundabout WB US 52 Preliminary

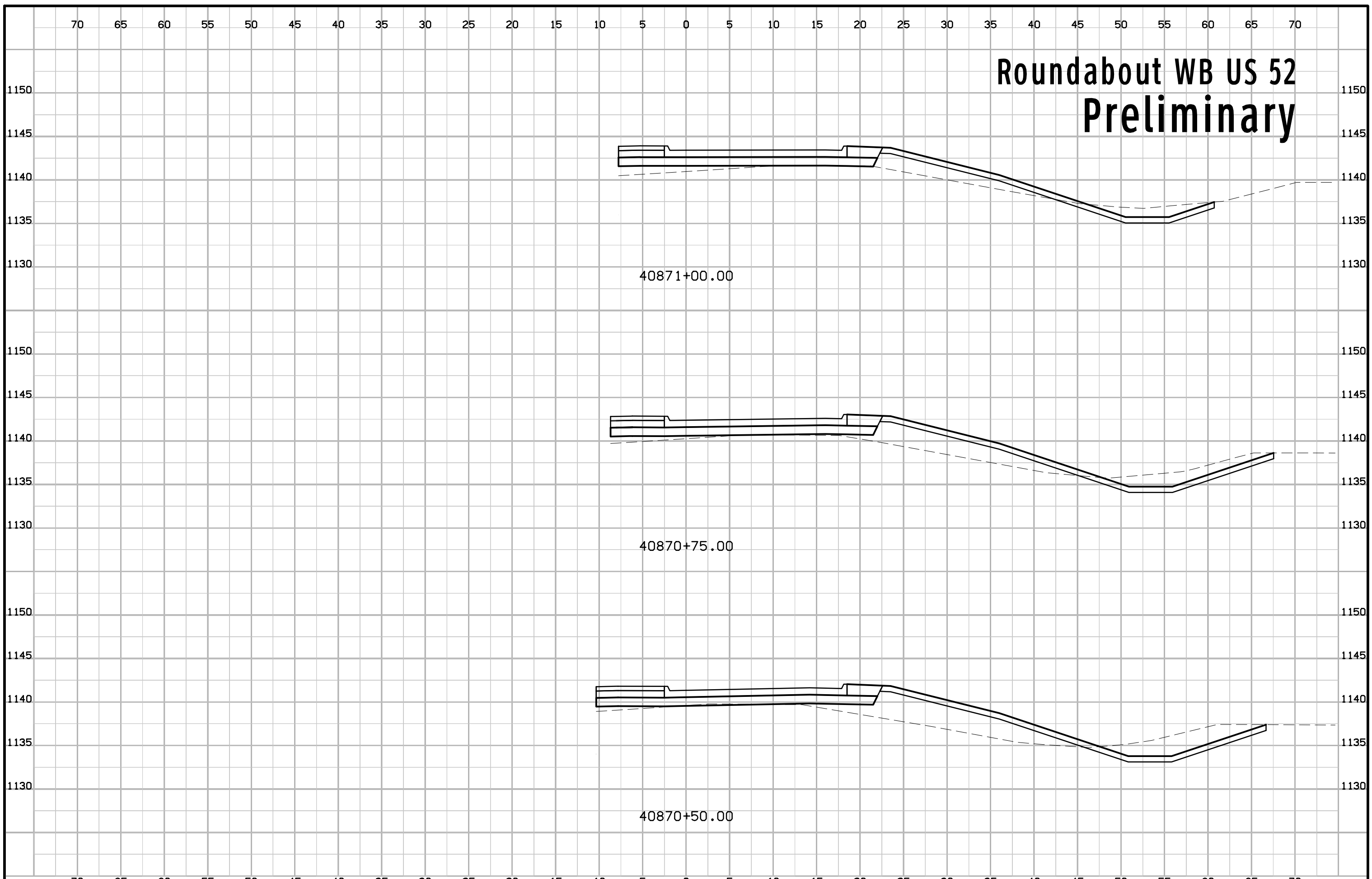

# Roundabout WB US 52 Preliminary

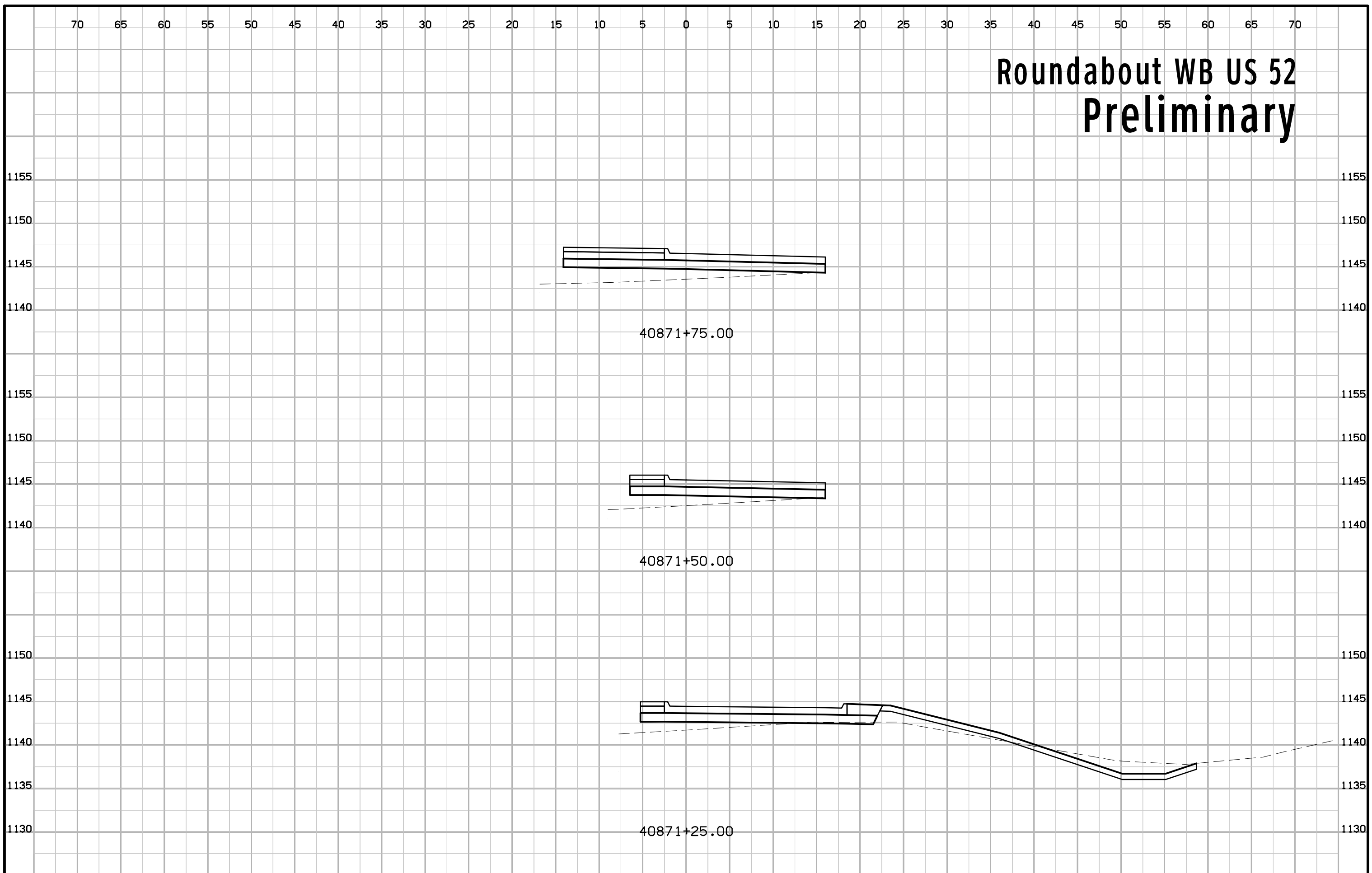

# Roundabout WB US 52 Preliminary

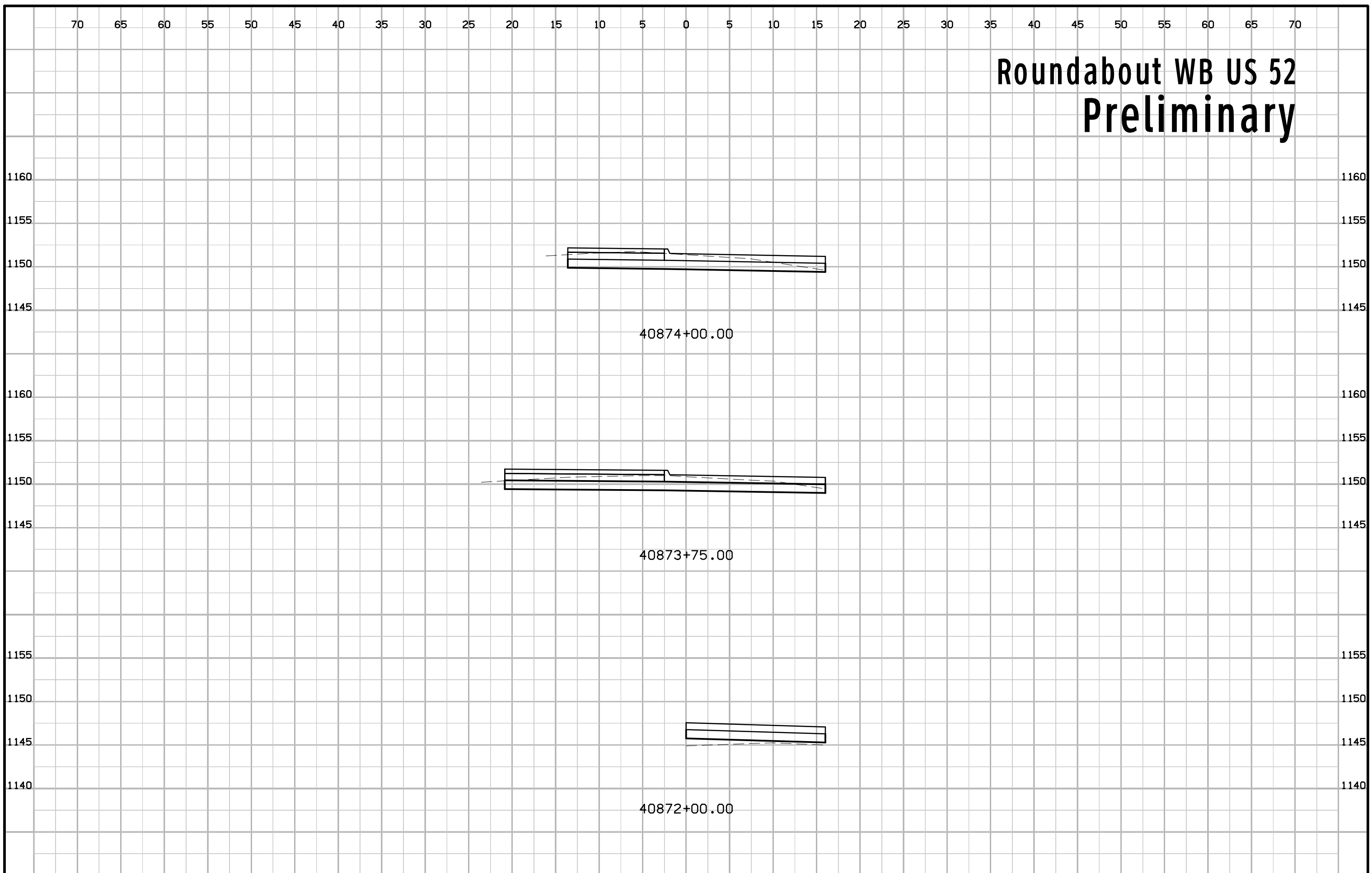

# Roundabout WB US 52 Preliminary

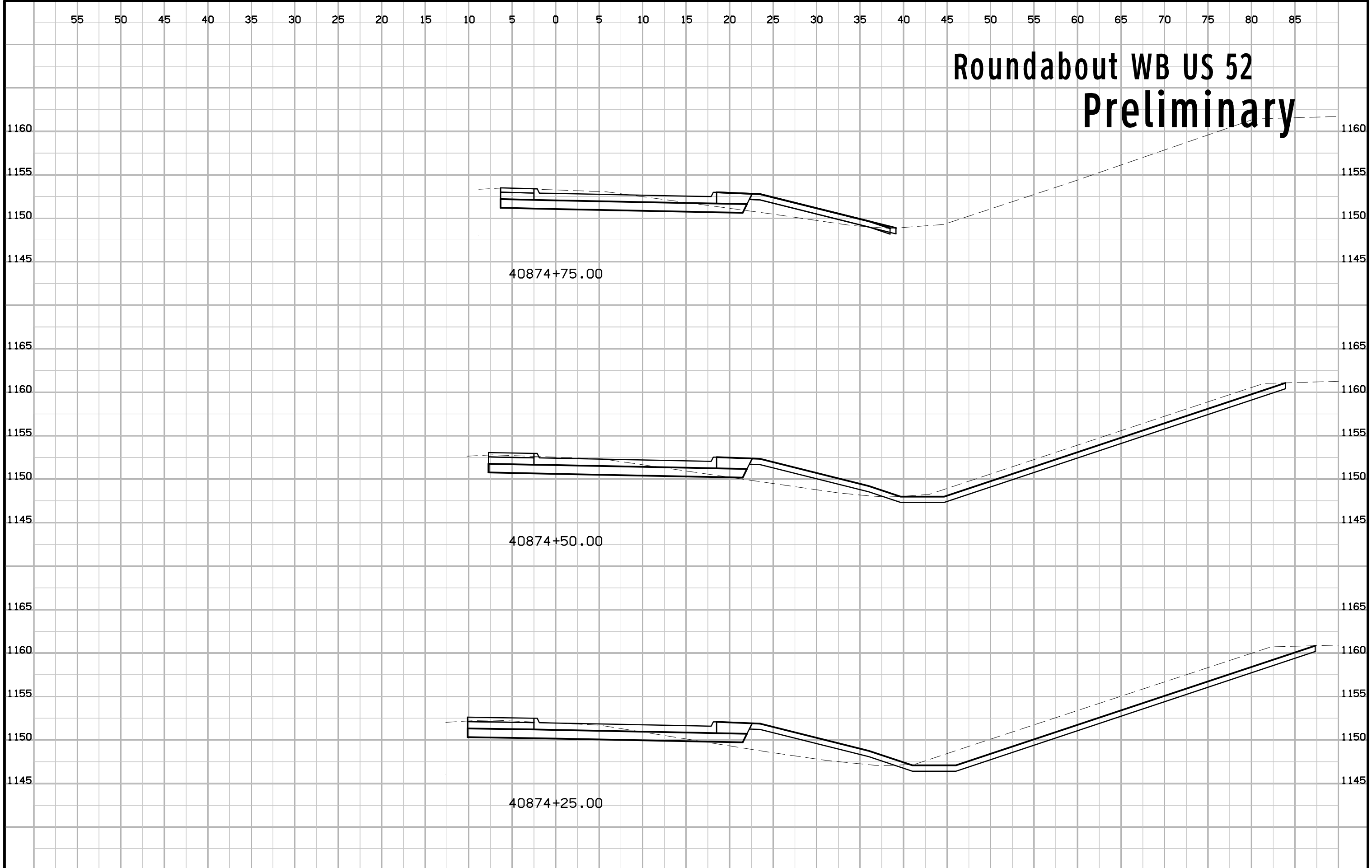

# Roundabout WB US 52 Preliminary

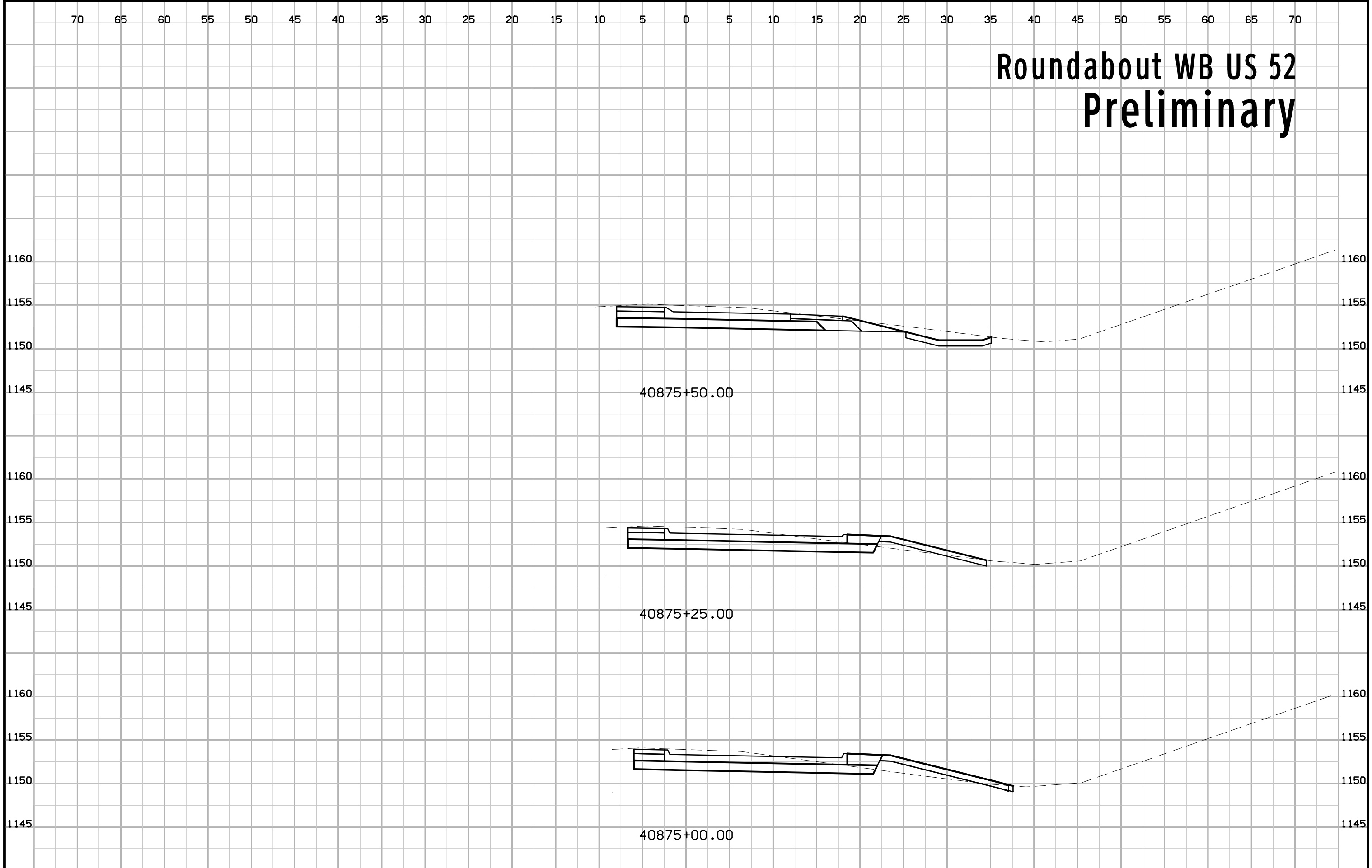

# Roundabout WB US 52 Preliminary

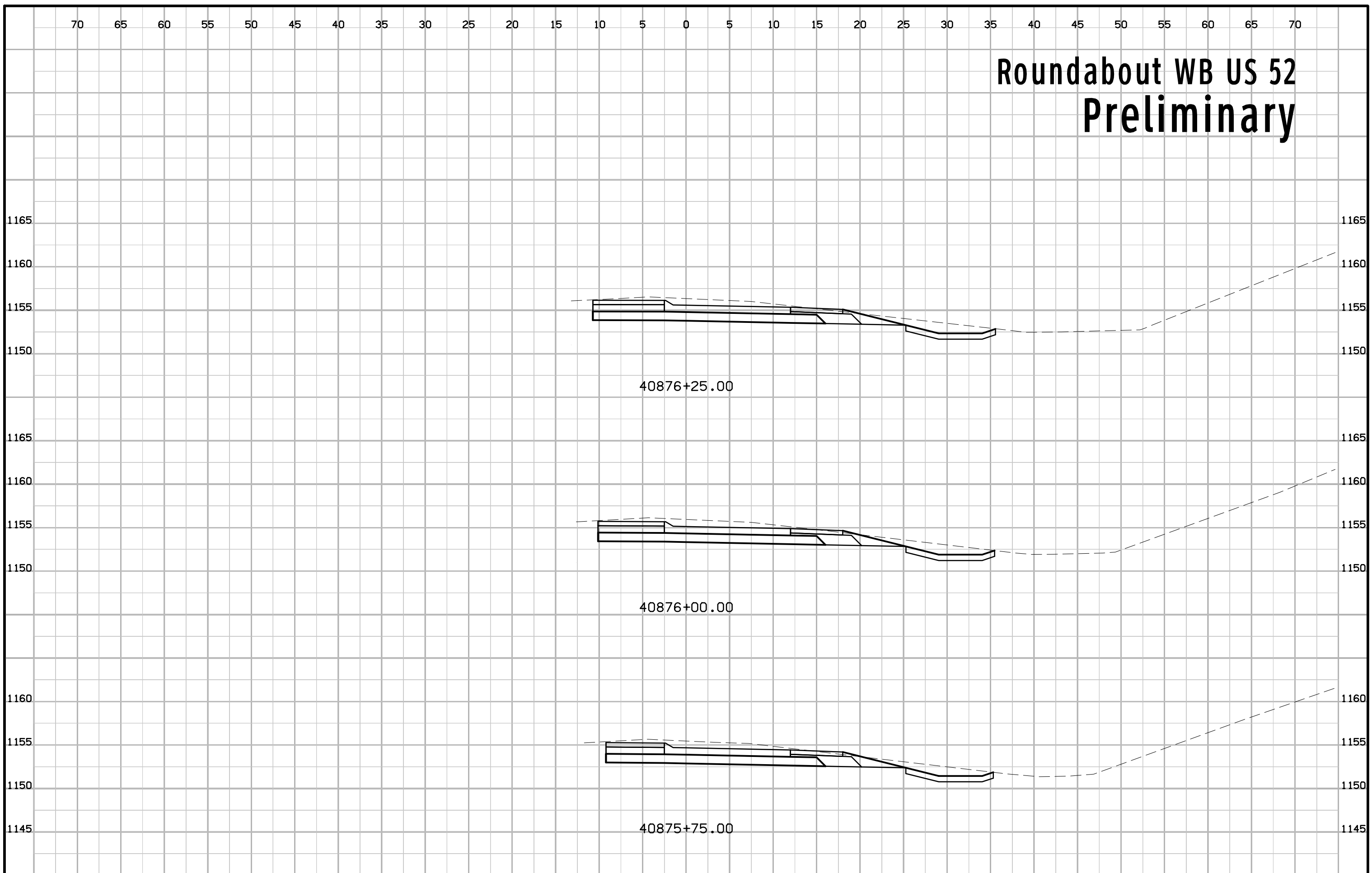

# Roundabout WB US 52 Preliminary

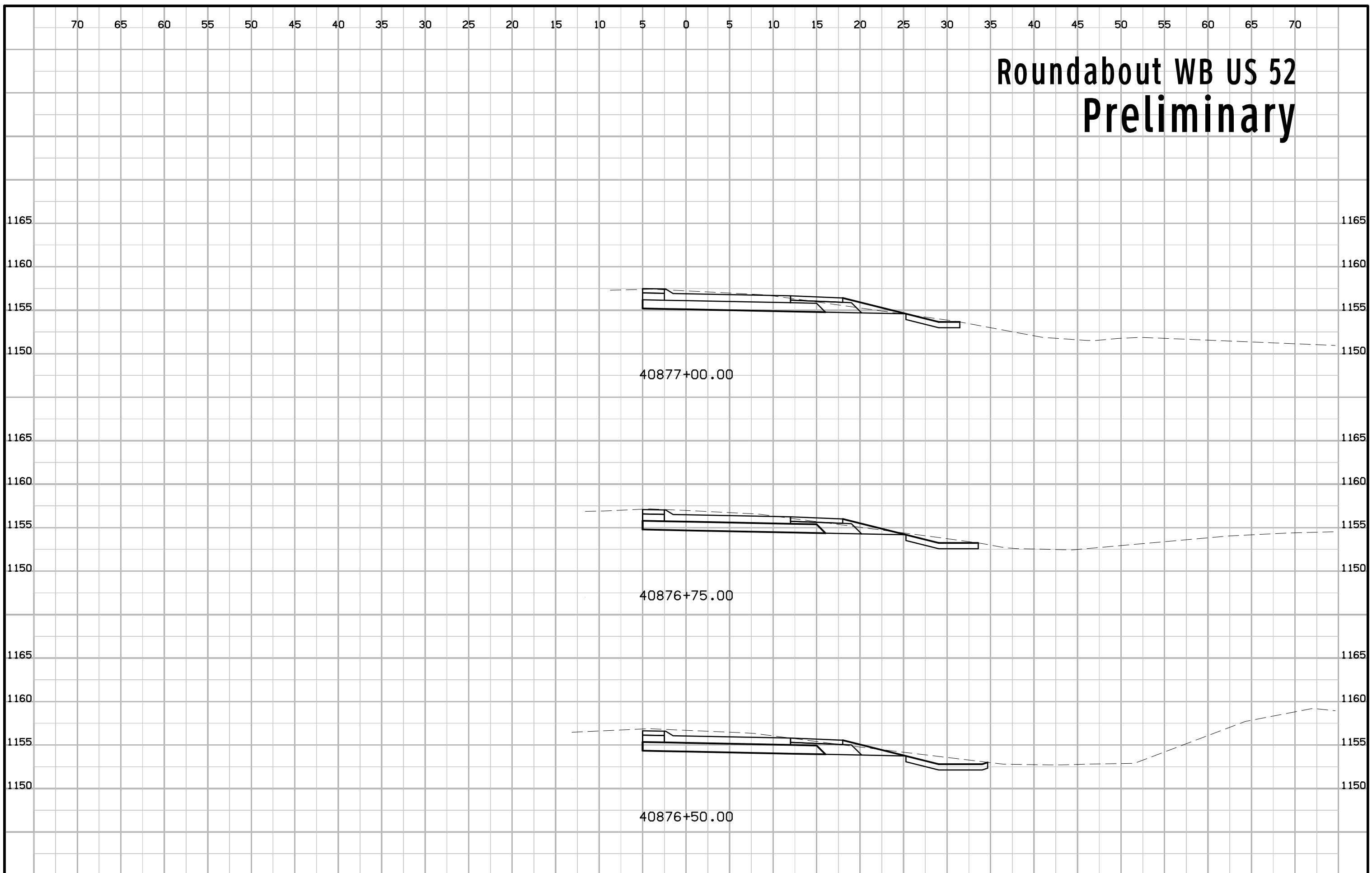

# Roundabout WB US 52 Preliminary

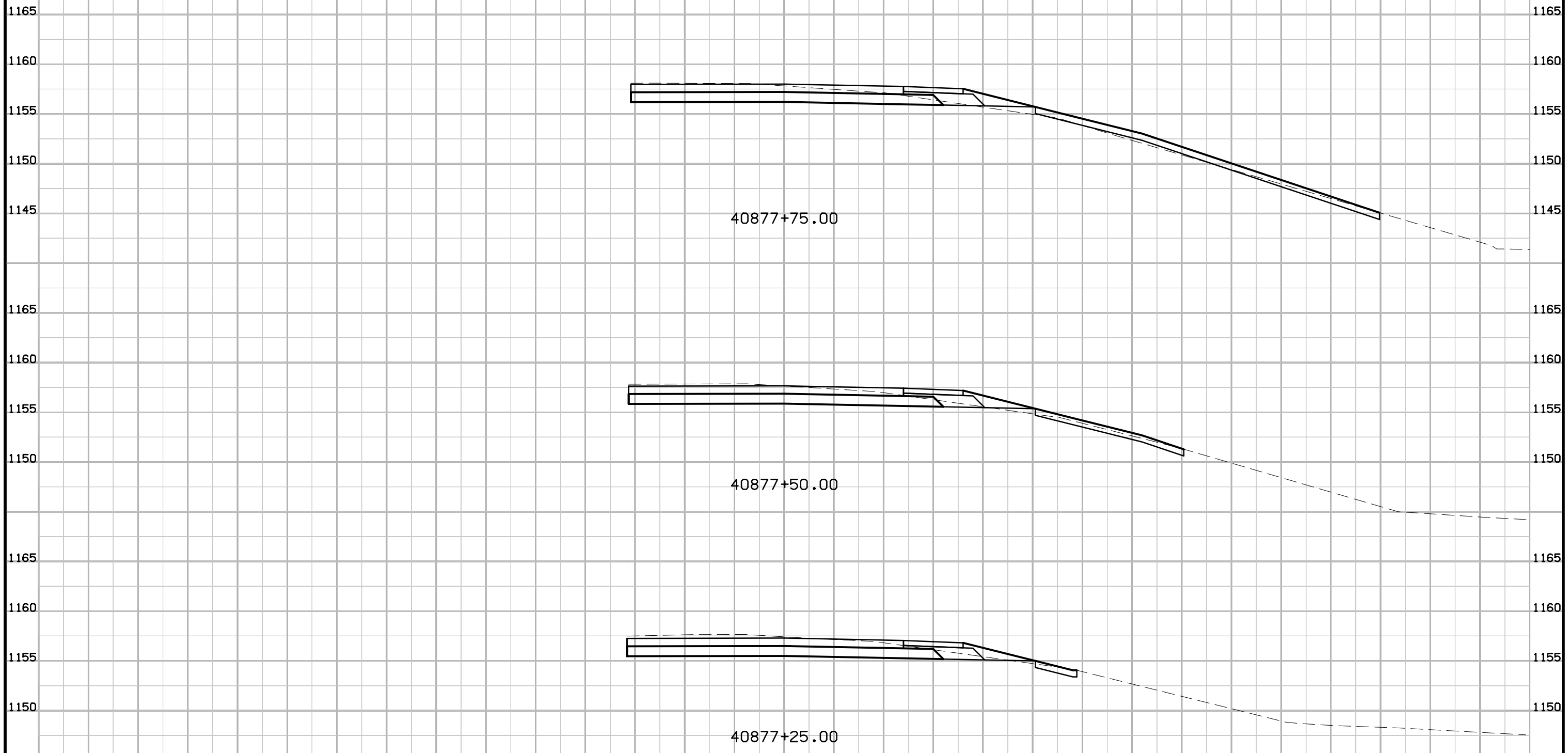



# Roundabout WB US 52 Preliminary

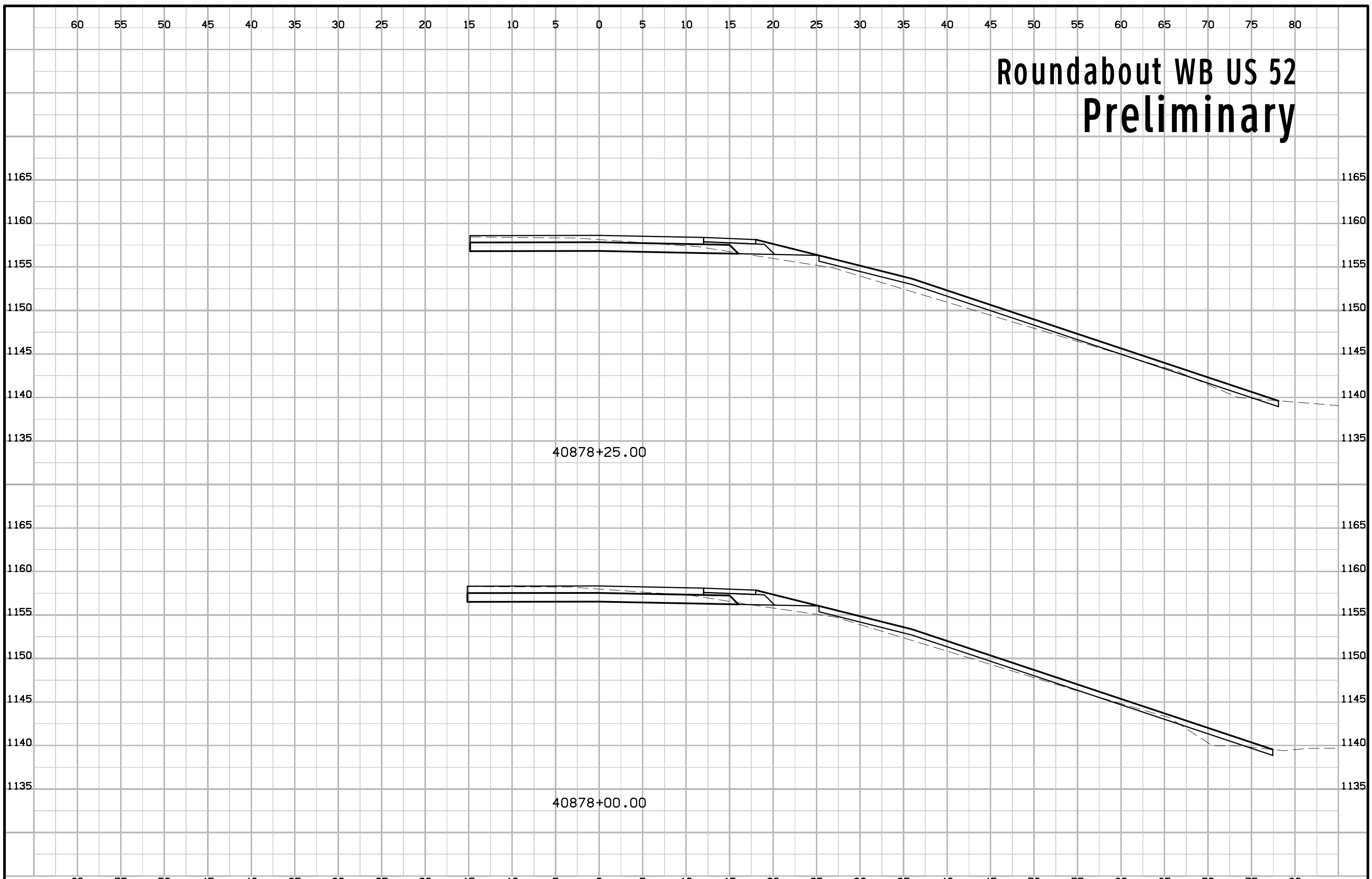

# Roundabout WB US 52 Preliminary

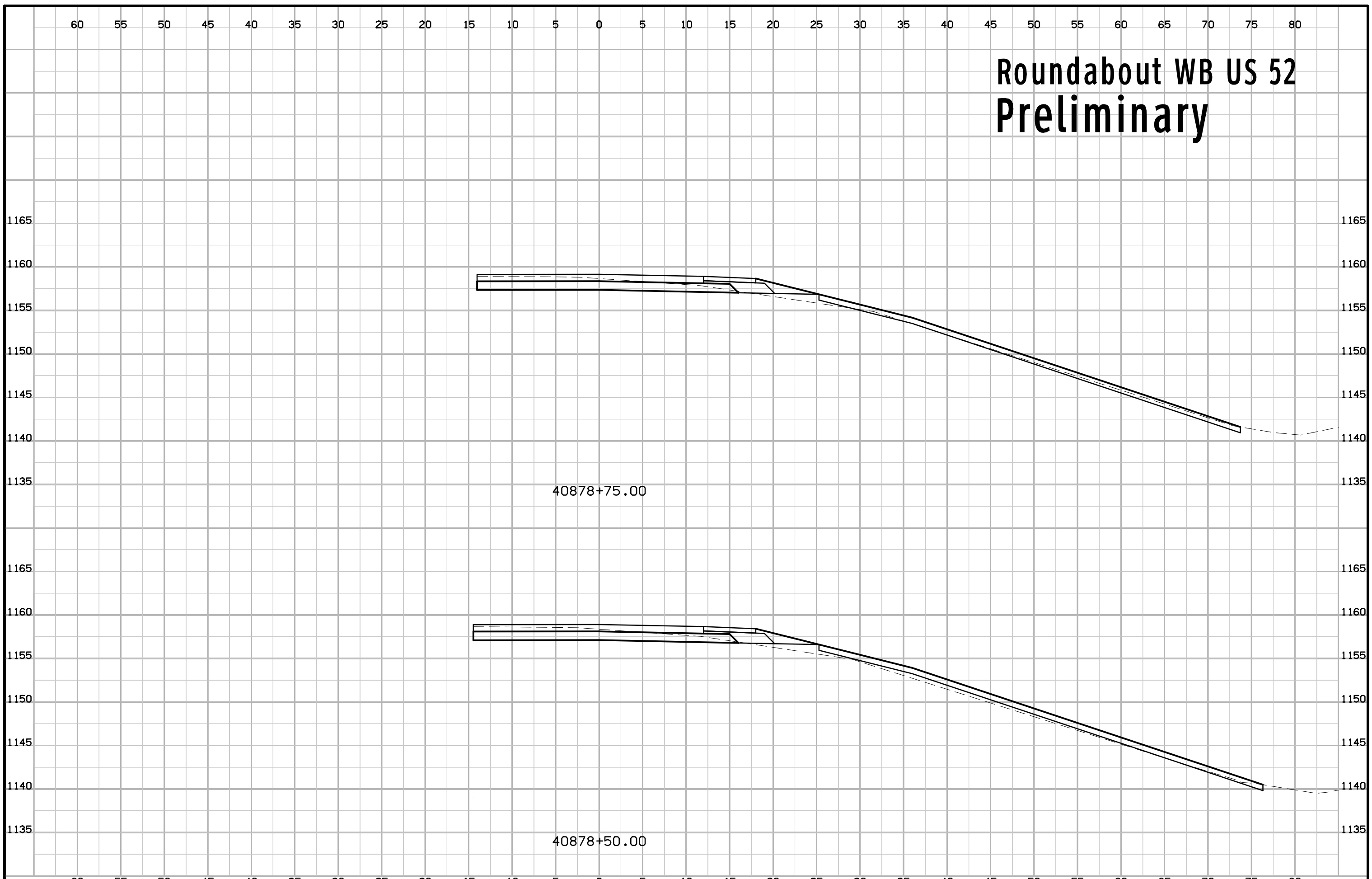

# Roundabout WB US 52 Preliminary

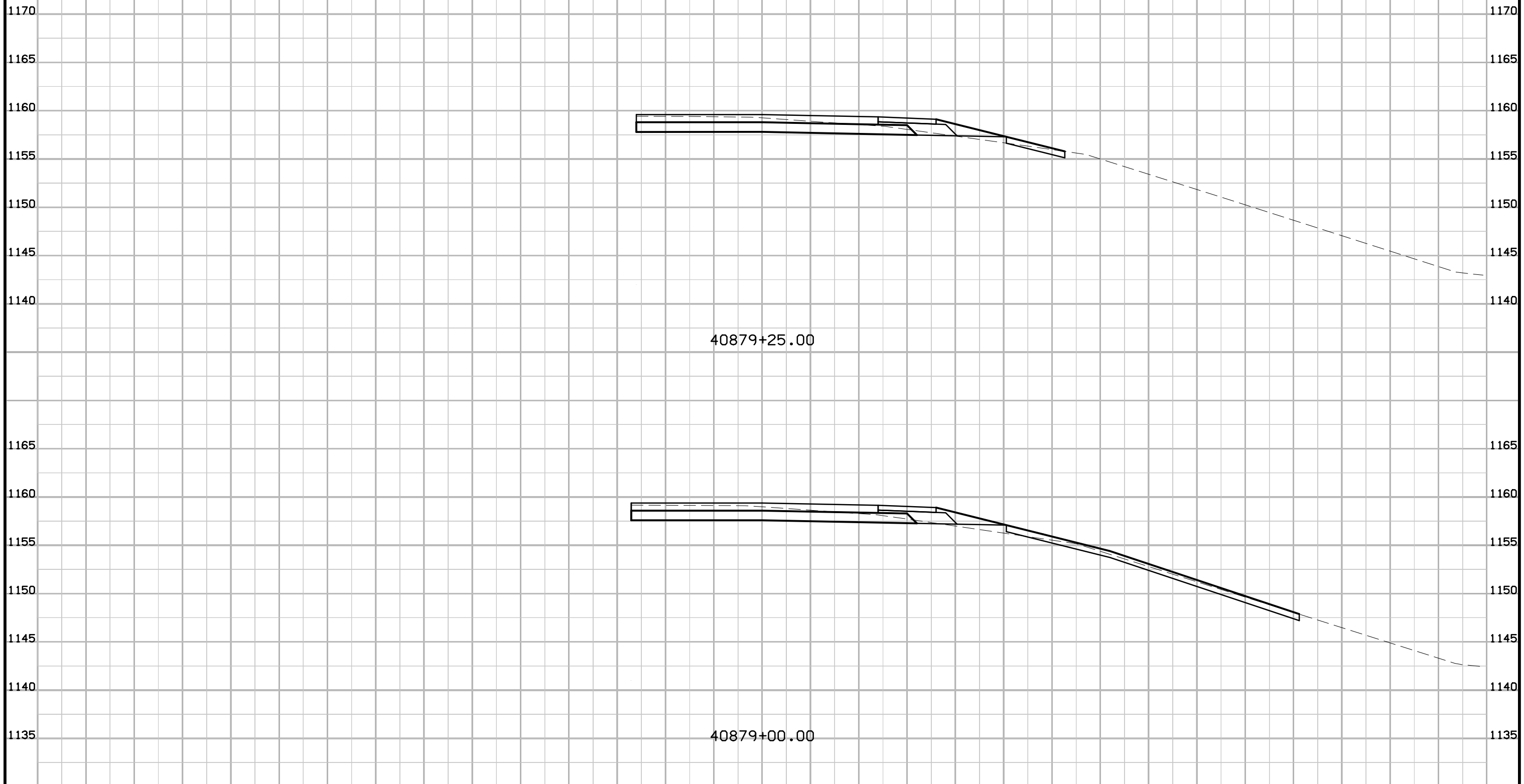

# Roundabout WB US 52 Preliminary

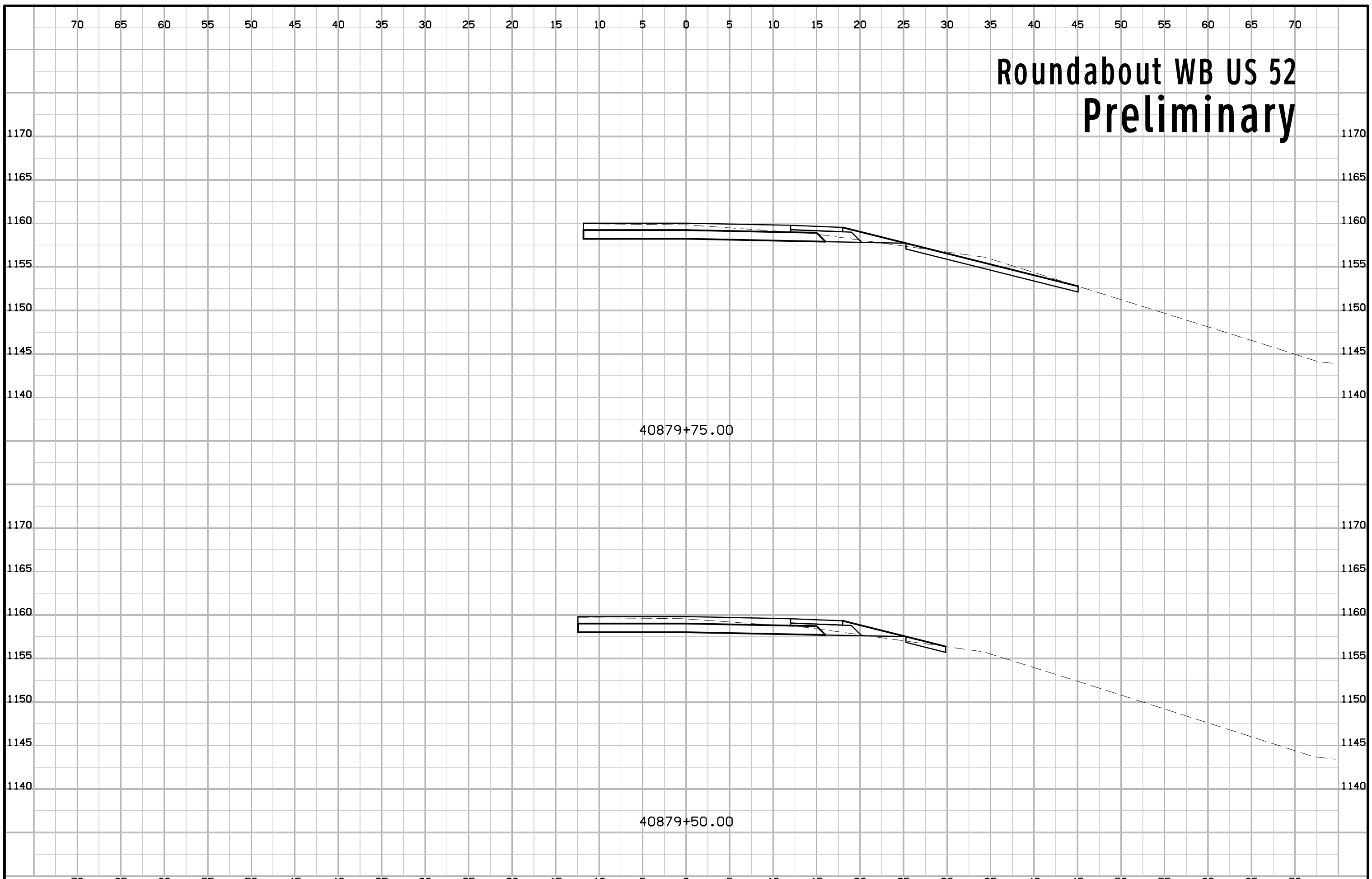

# Roundabout WB US 52 Preliminary

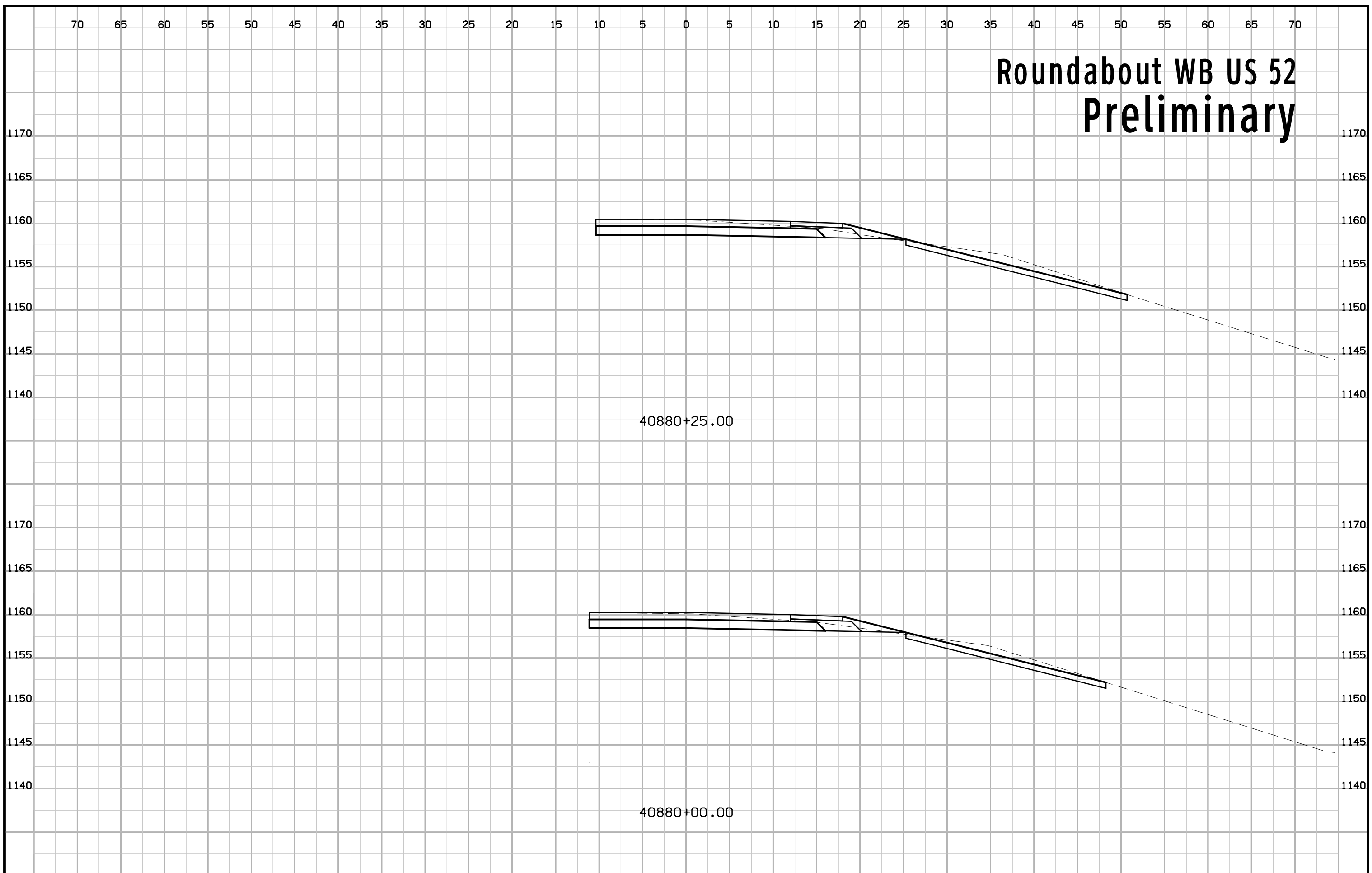

# Roundabout WB US 52 Preliminary

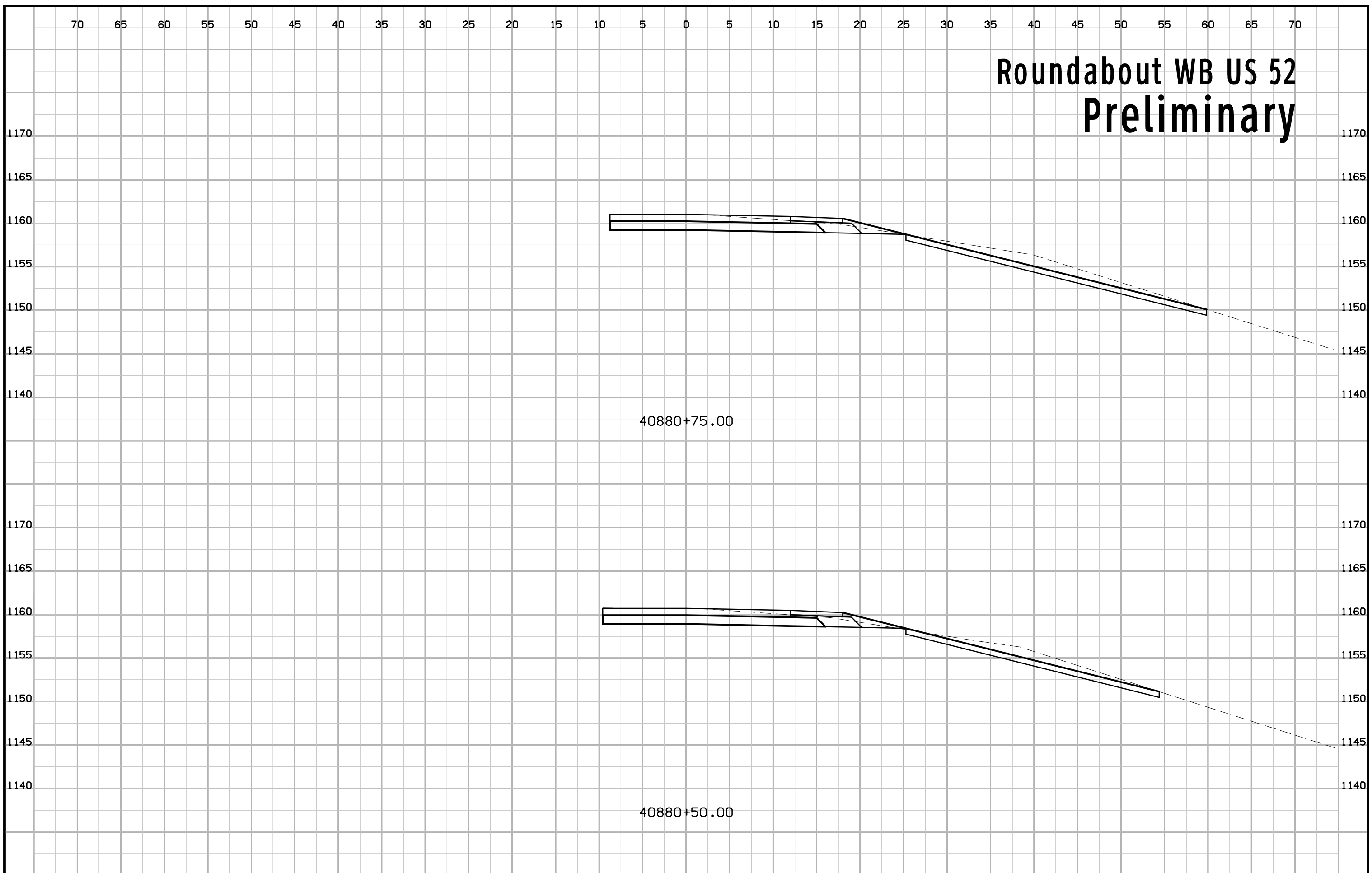

# Roundabout WB US 52 Preliminary

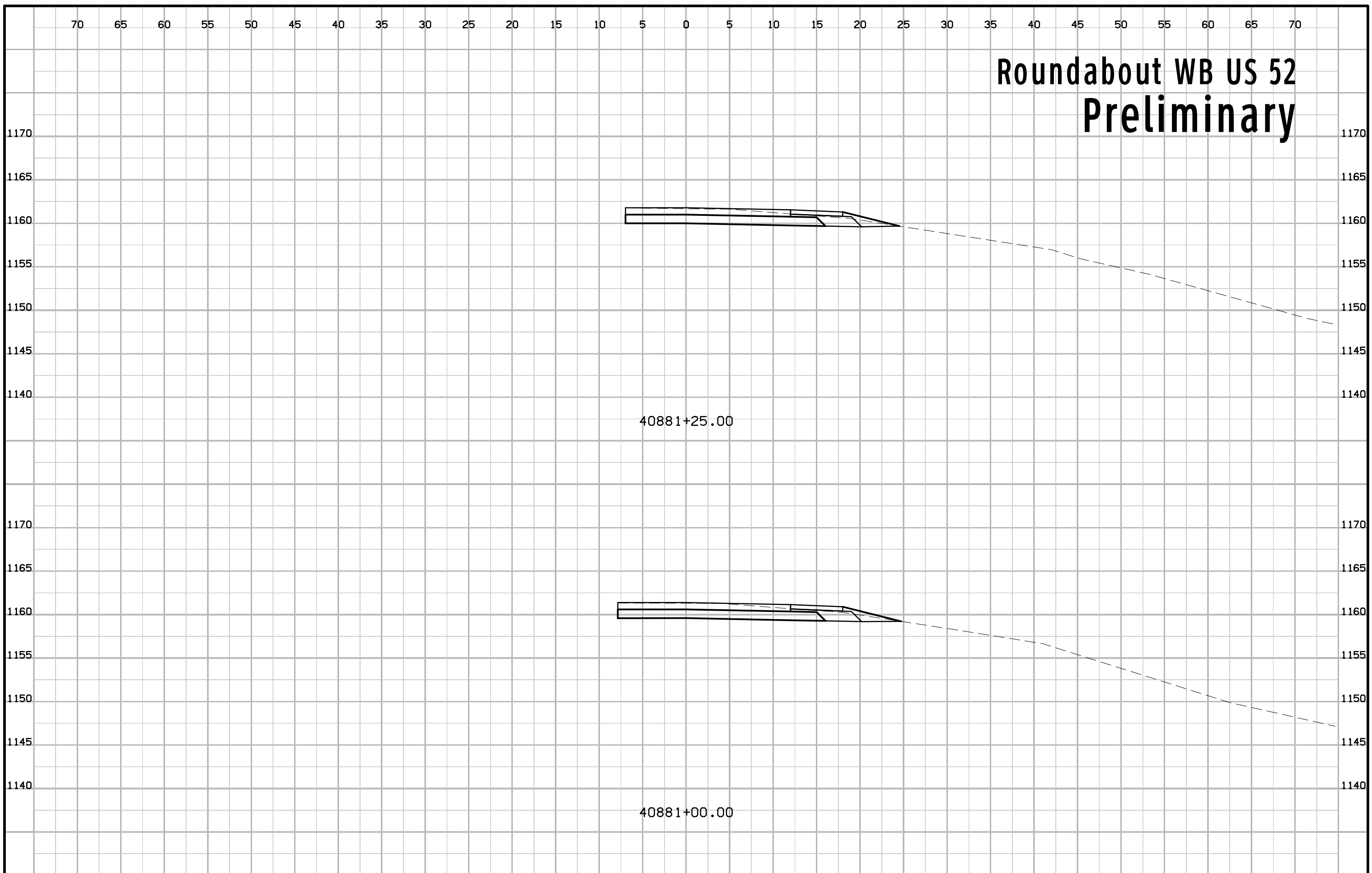

# Roundabout WB US 52 Preliminary

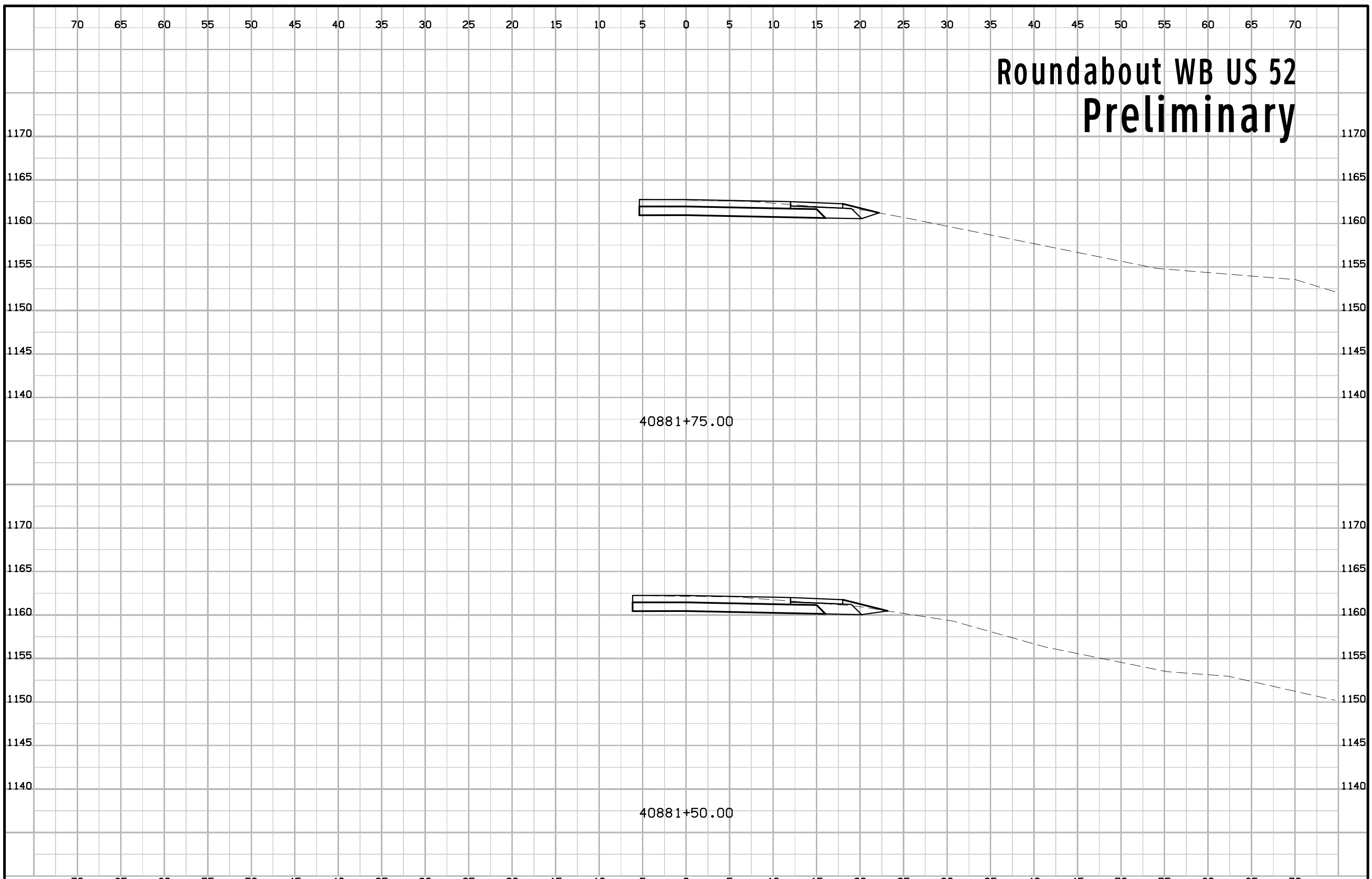



# Roundabout WB US 52 Preliminary

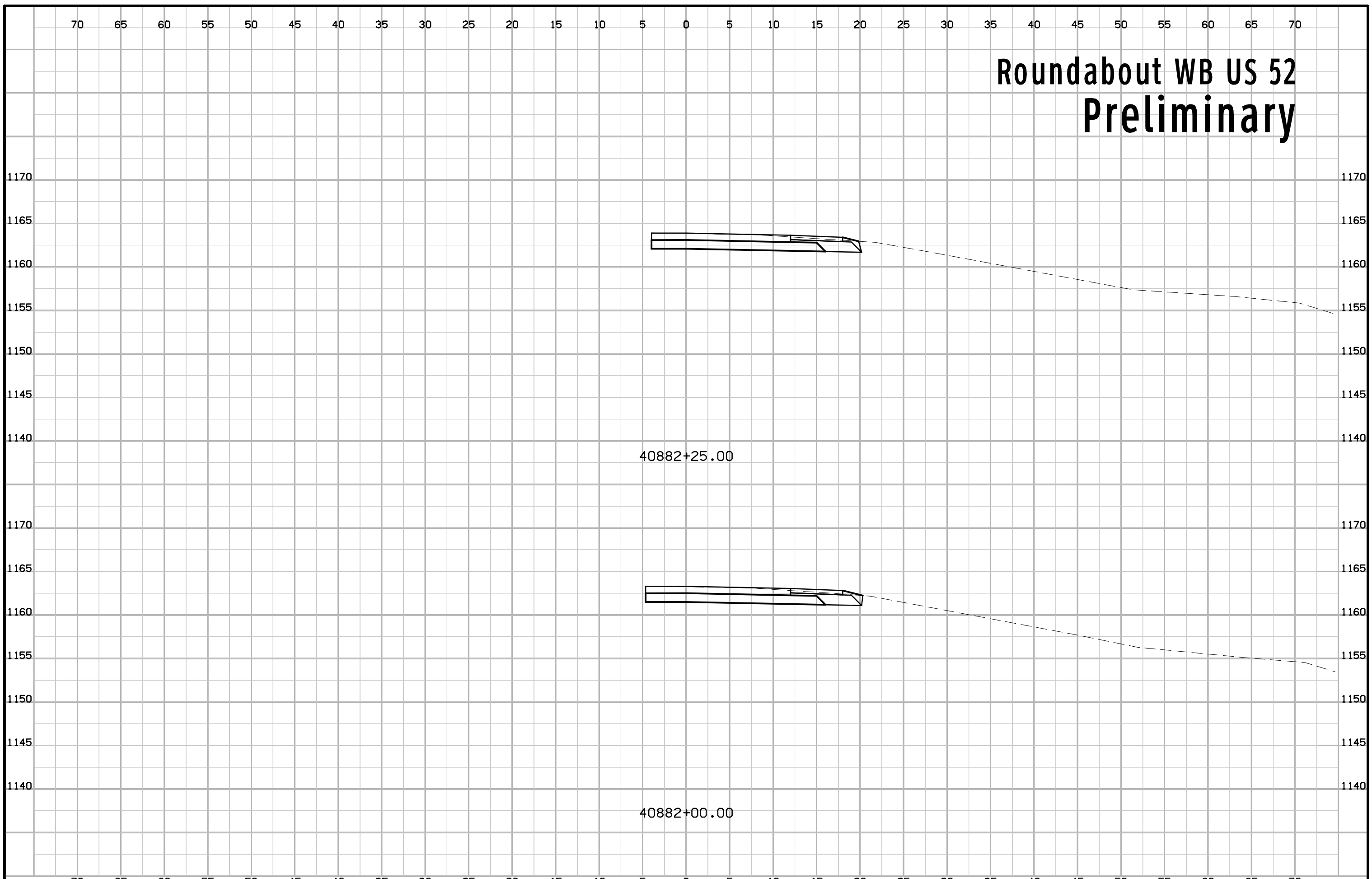

# Roundabout WB US 52 Preliminary

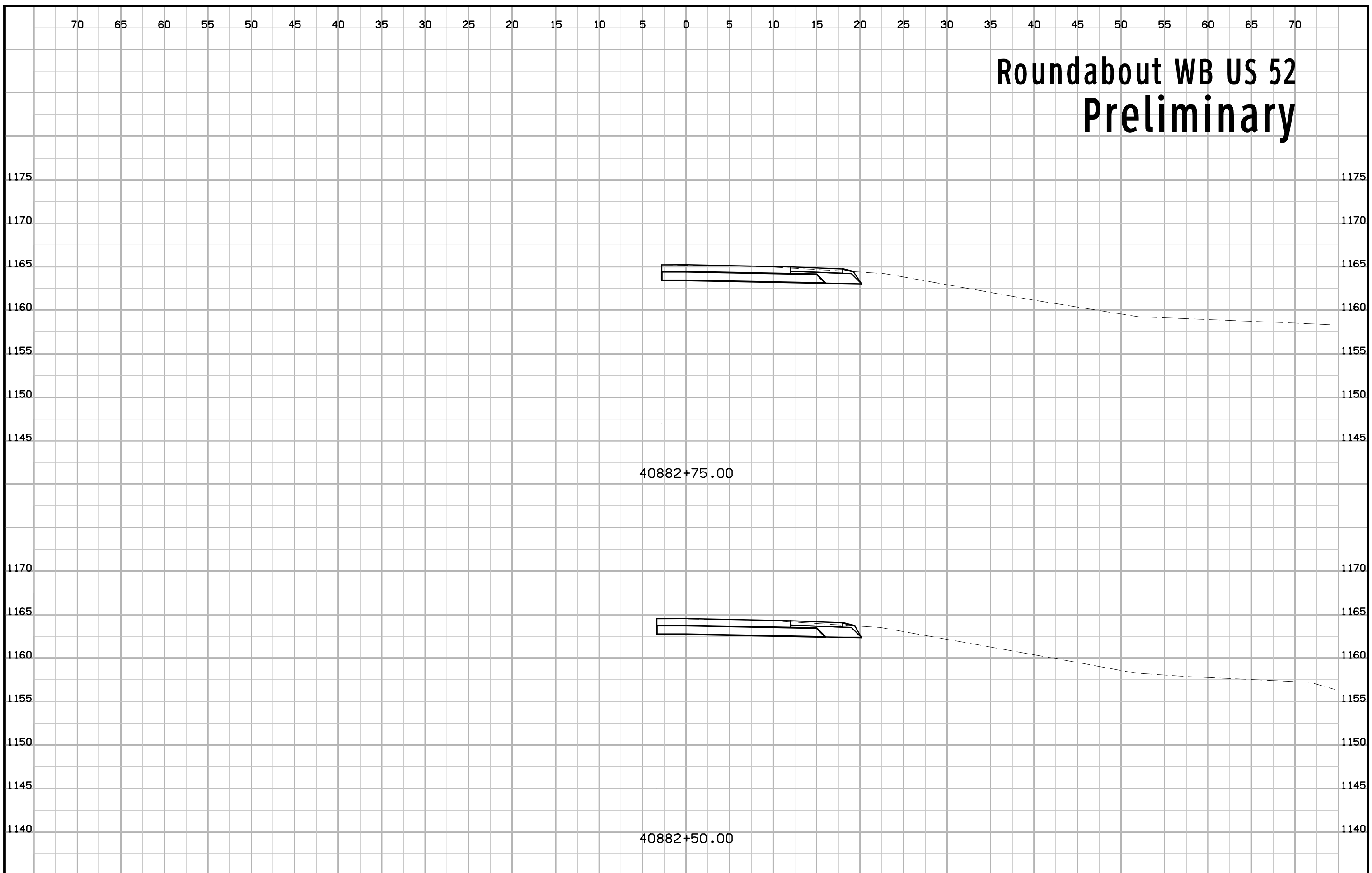

# Roundabout WB US 52 Preliminary

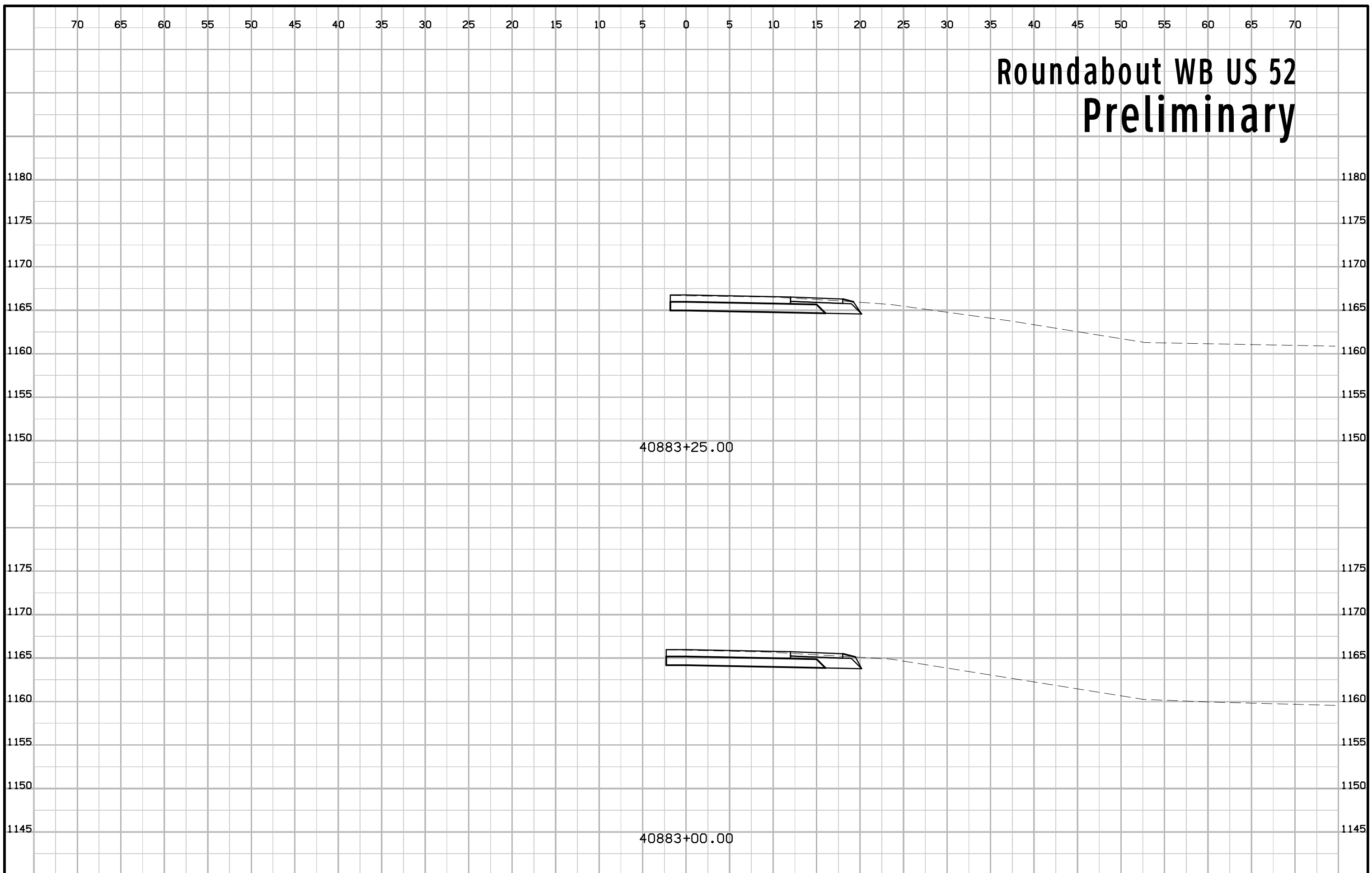

# Roundabout WB US 52 Preliminary

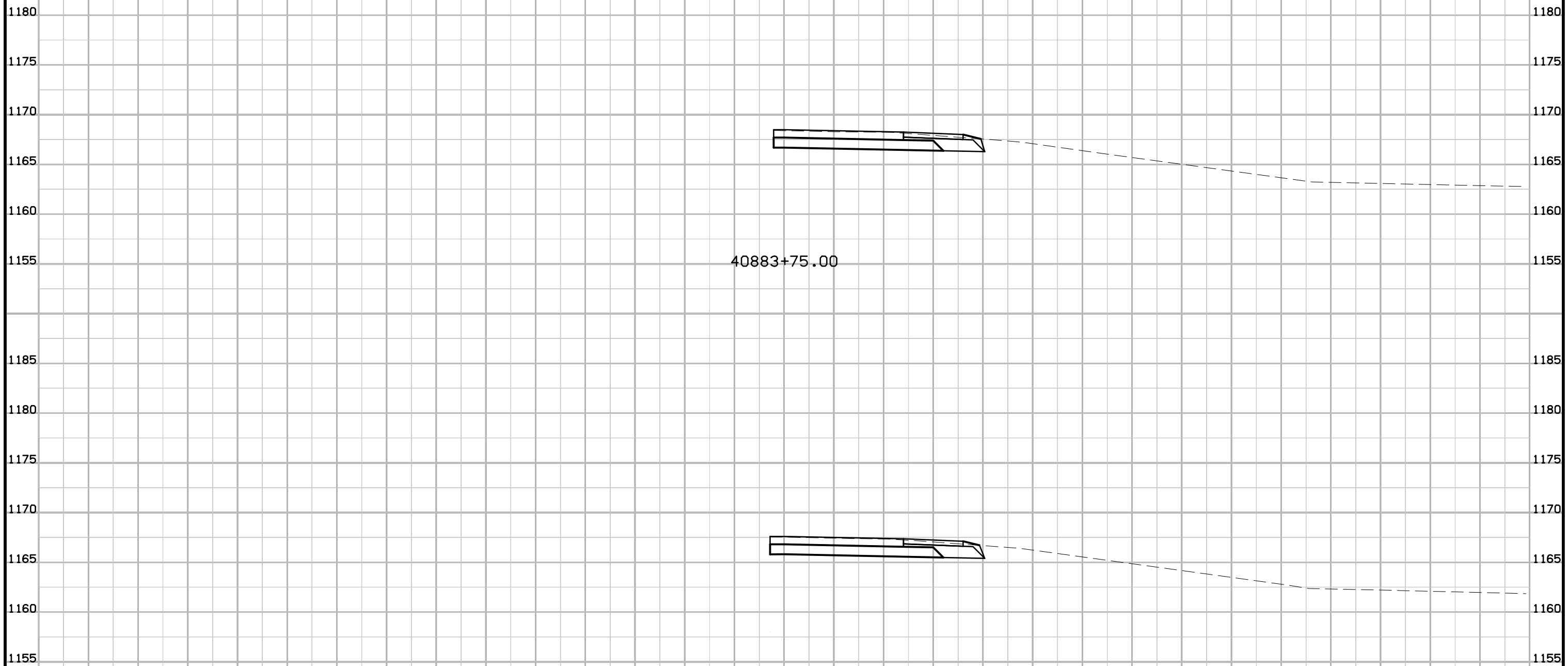

# Roundabout WB US 52 Preliminary

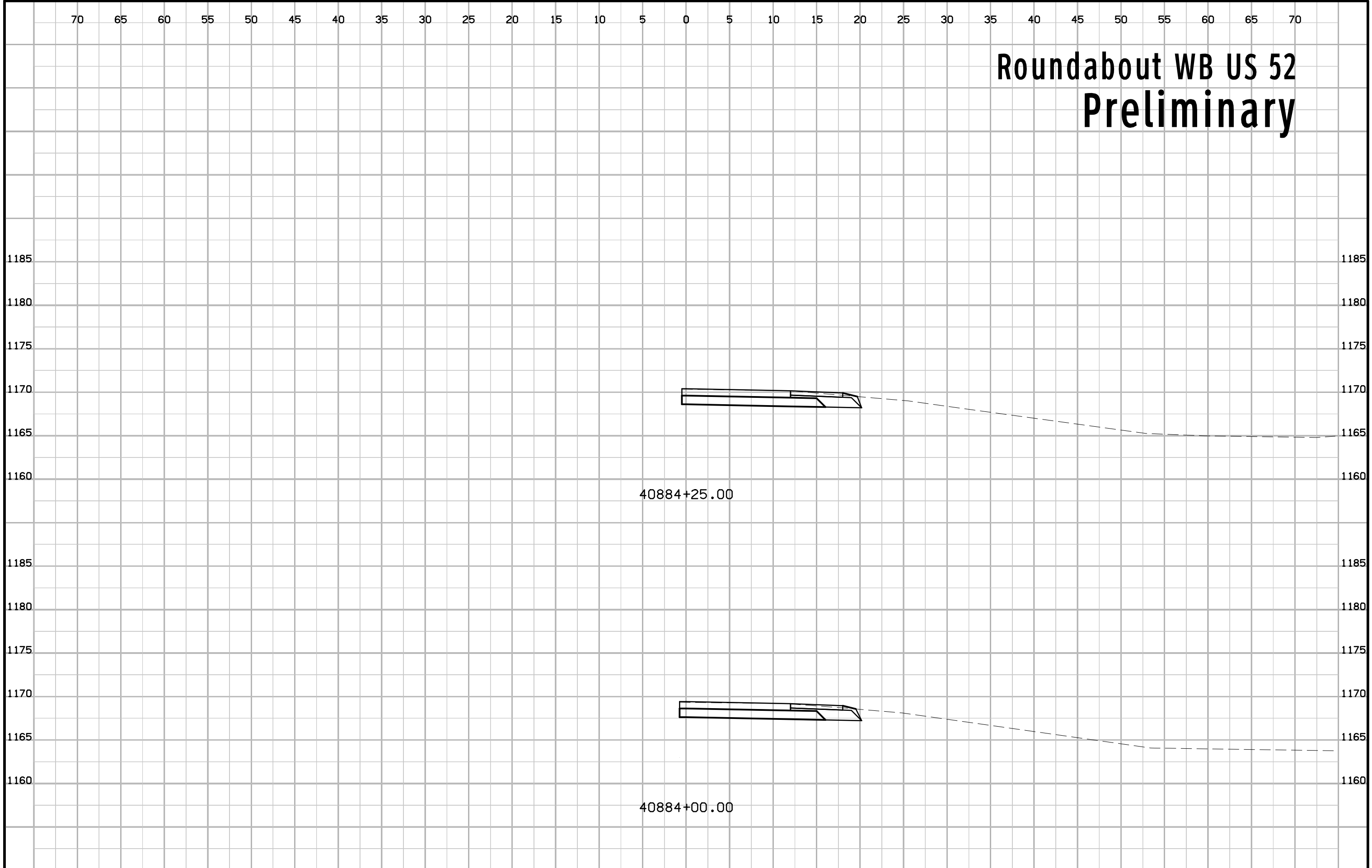

# Roundabout WB US 52 Preliminary

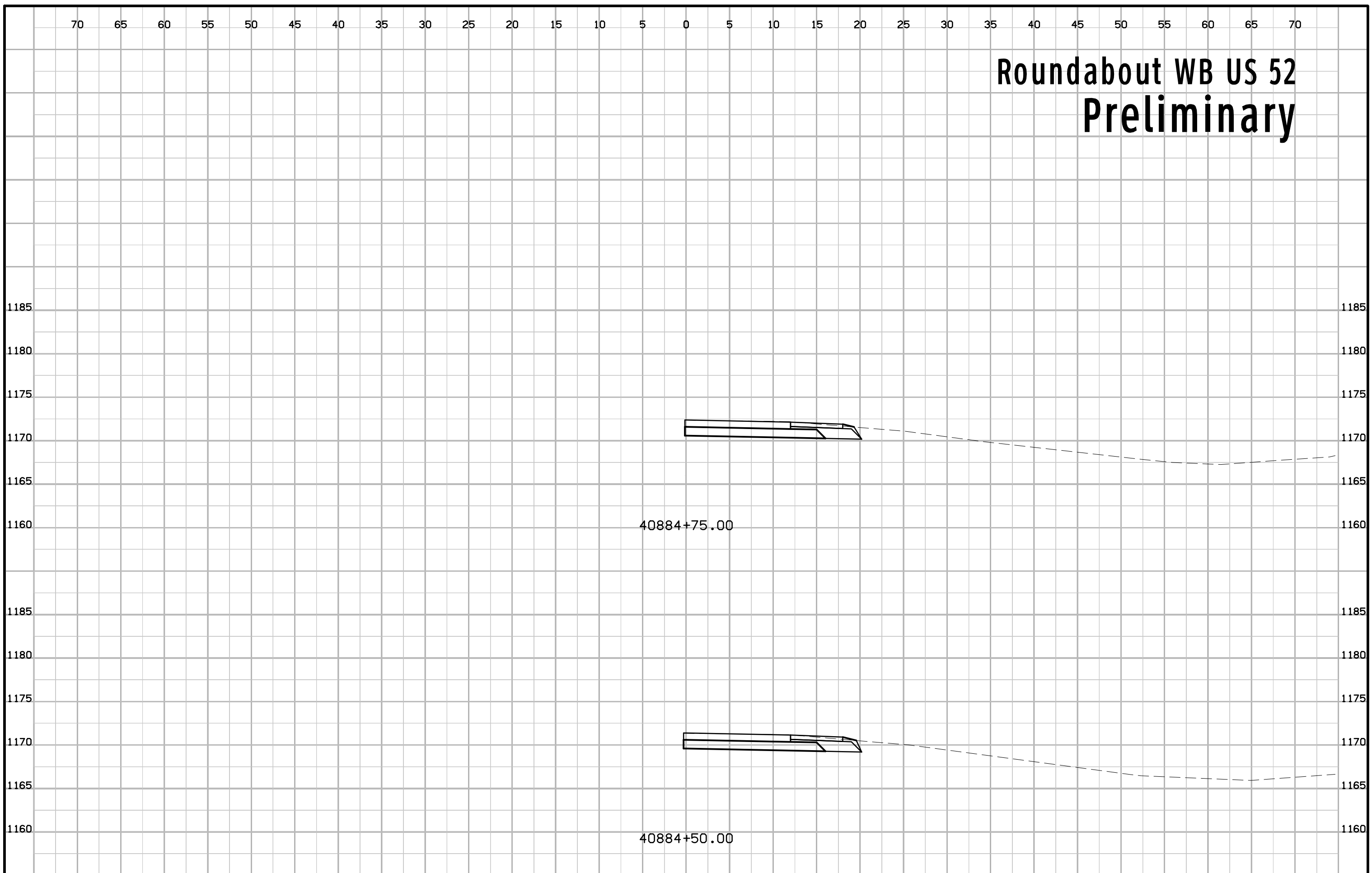

# Roundabout WB US 52 Preliminary

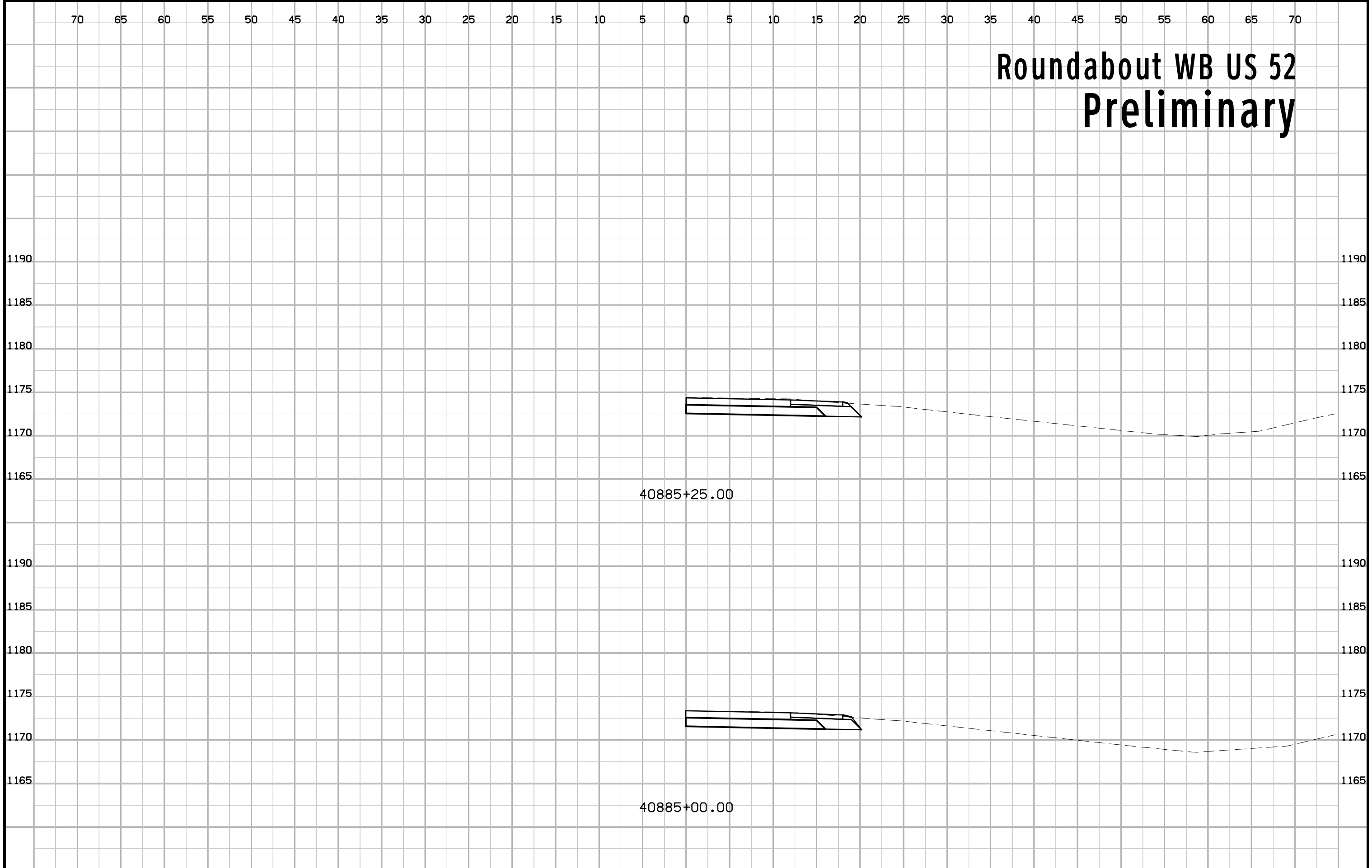

# Roundabout WB US 52 Preliminary

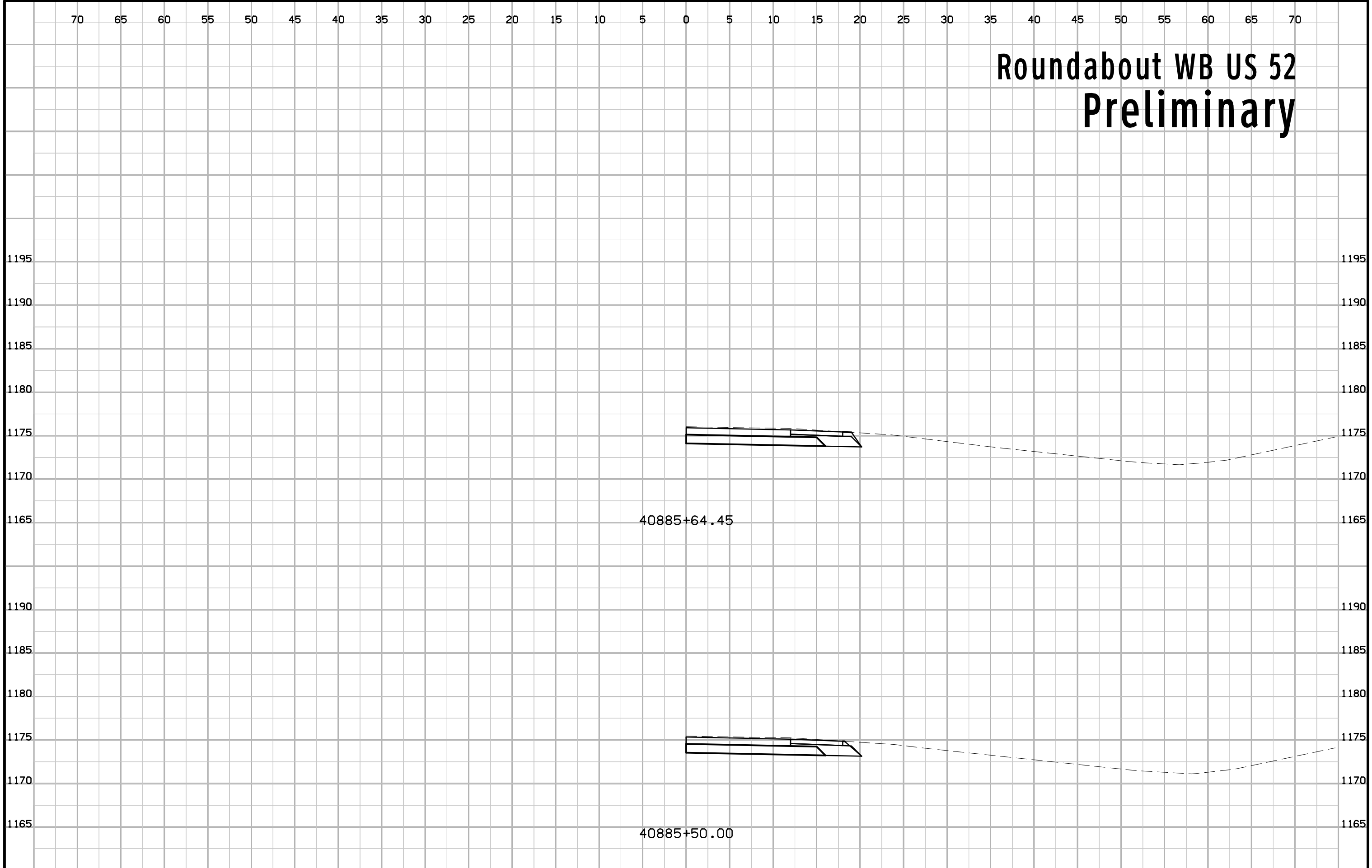



# Roundabout EB US 52 Preliminary

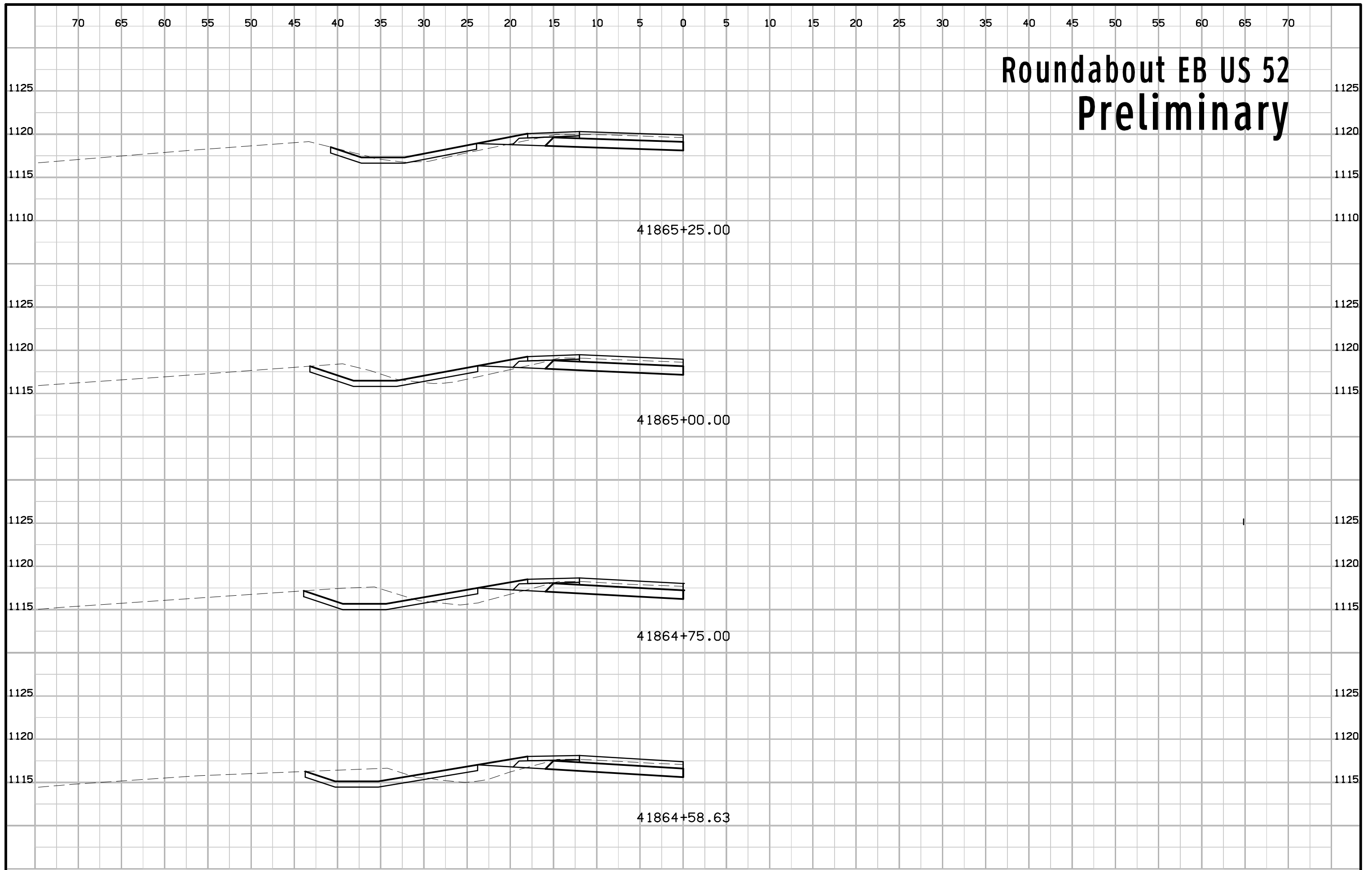

# Roundabout EB US 52 Preliminary

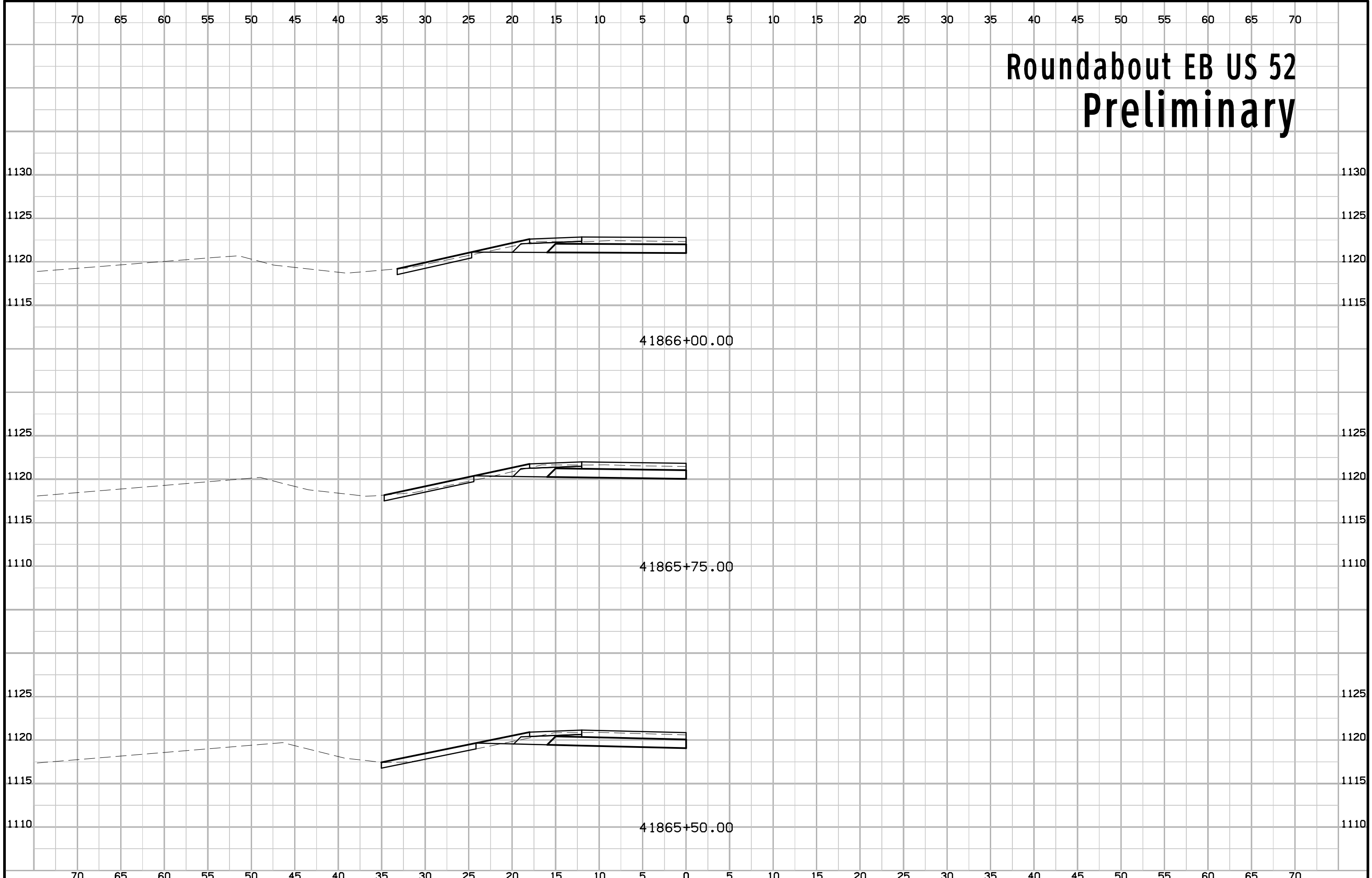

# Roundabout EB US 52 Preliminary

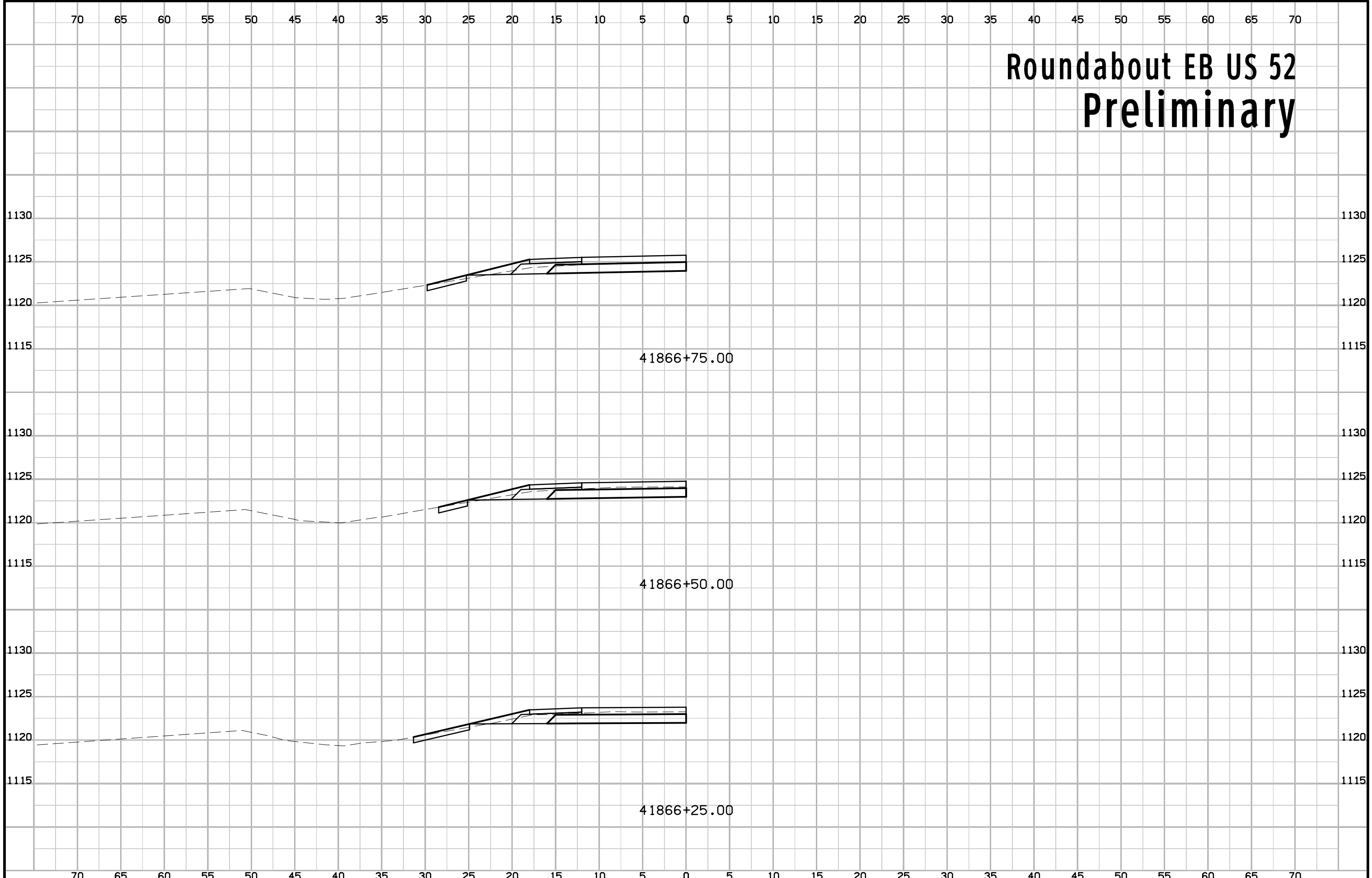

# Roundabout EB US 52 Preliminary

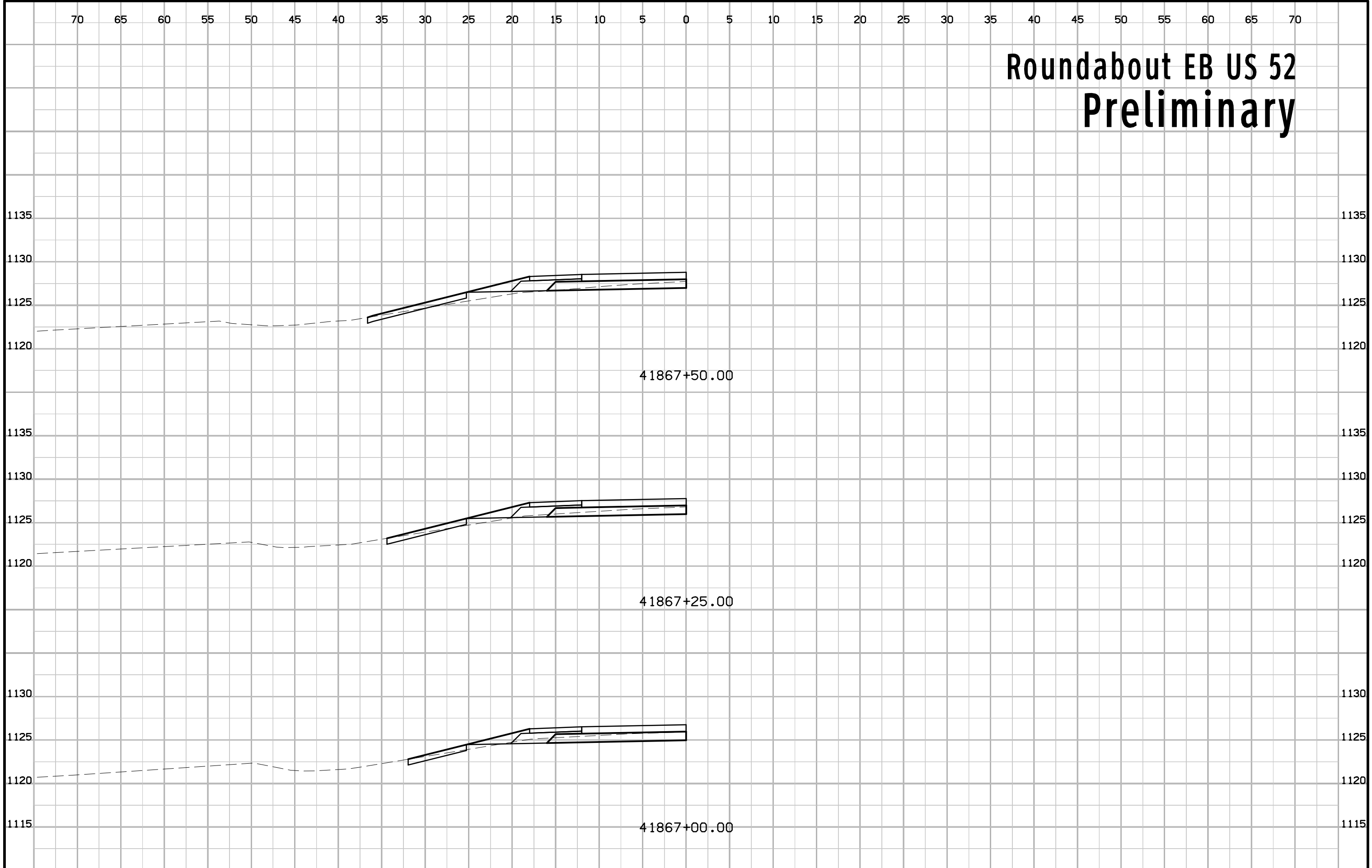

# Roundabout EB US 52 Preliminary

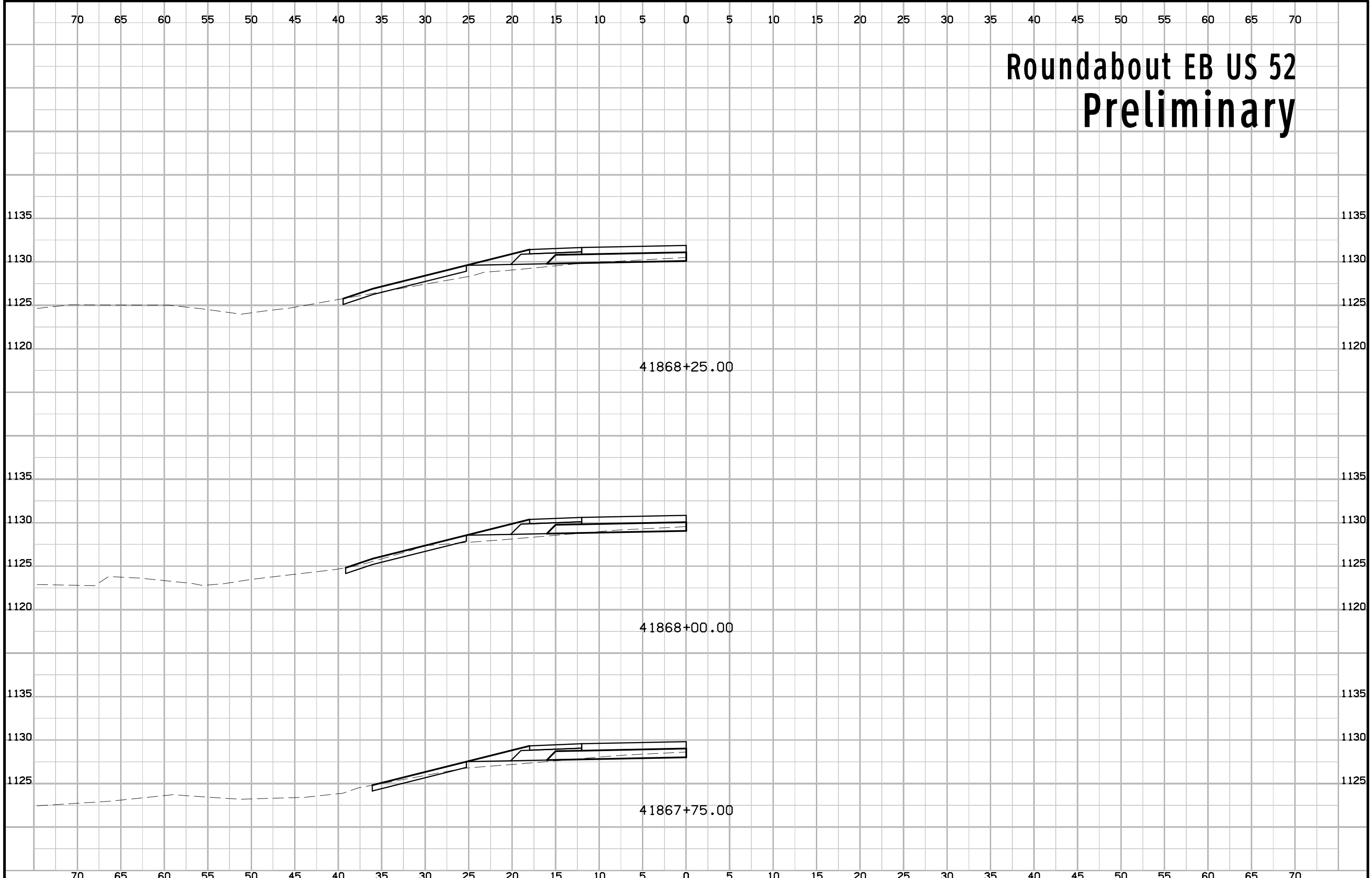

# Roundabout EB US 52 Preliminary

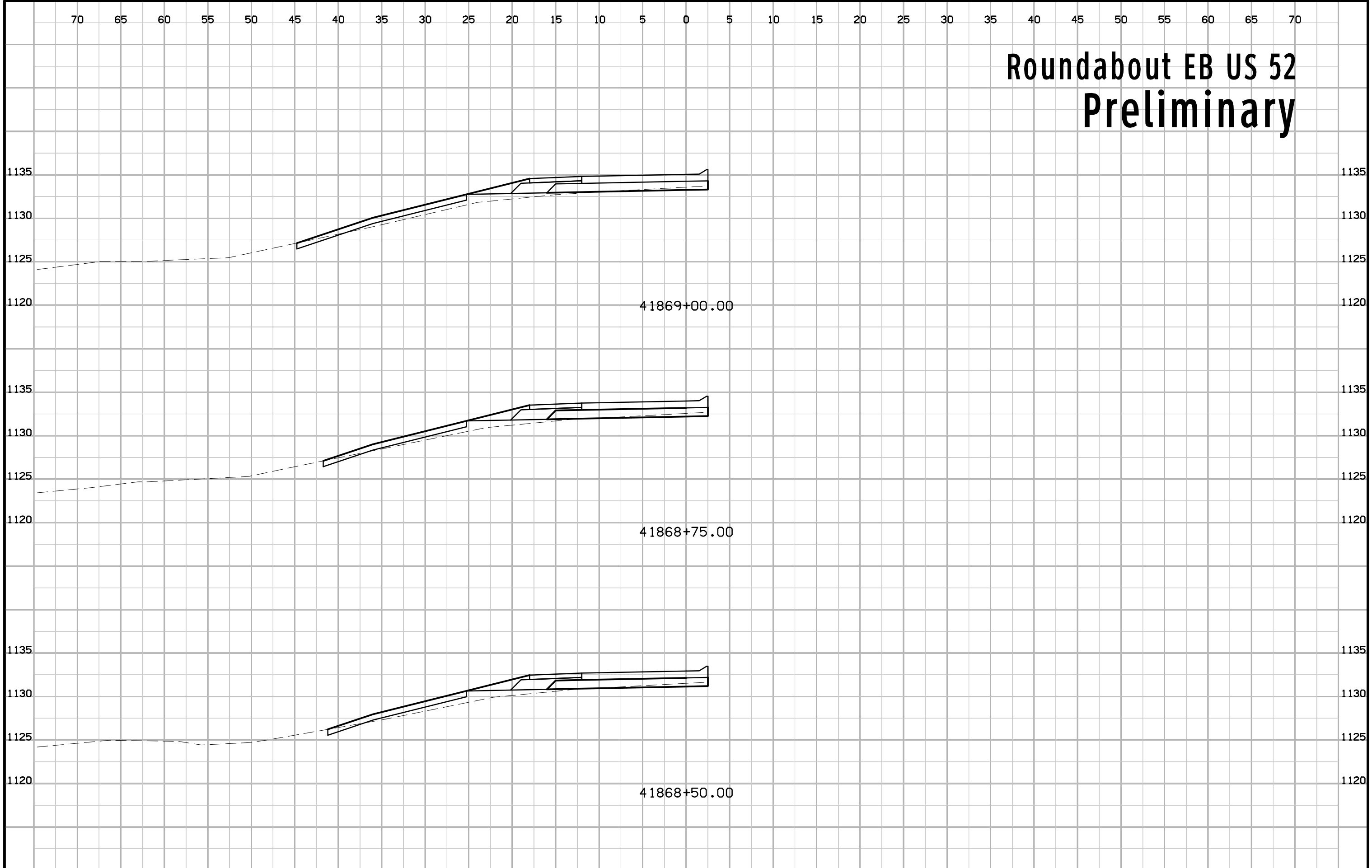

# Roundabout EB US 52 Preliminary

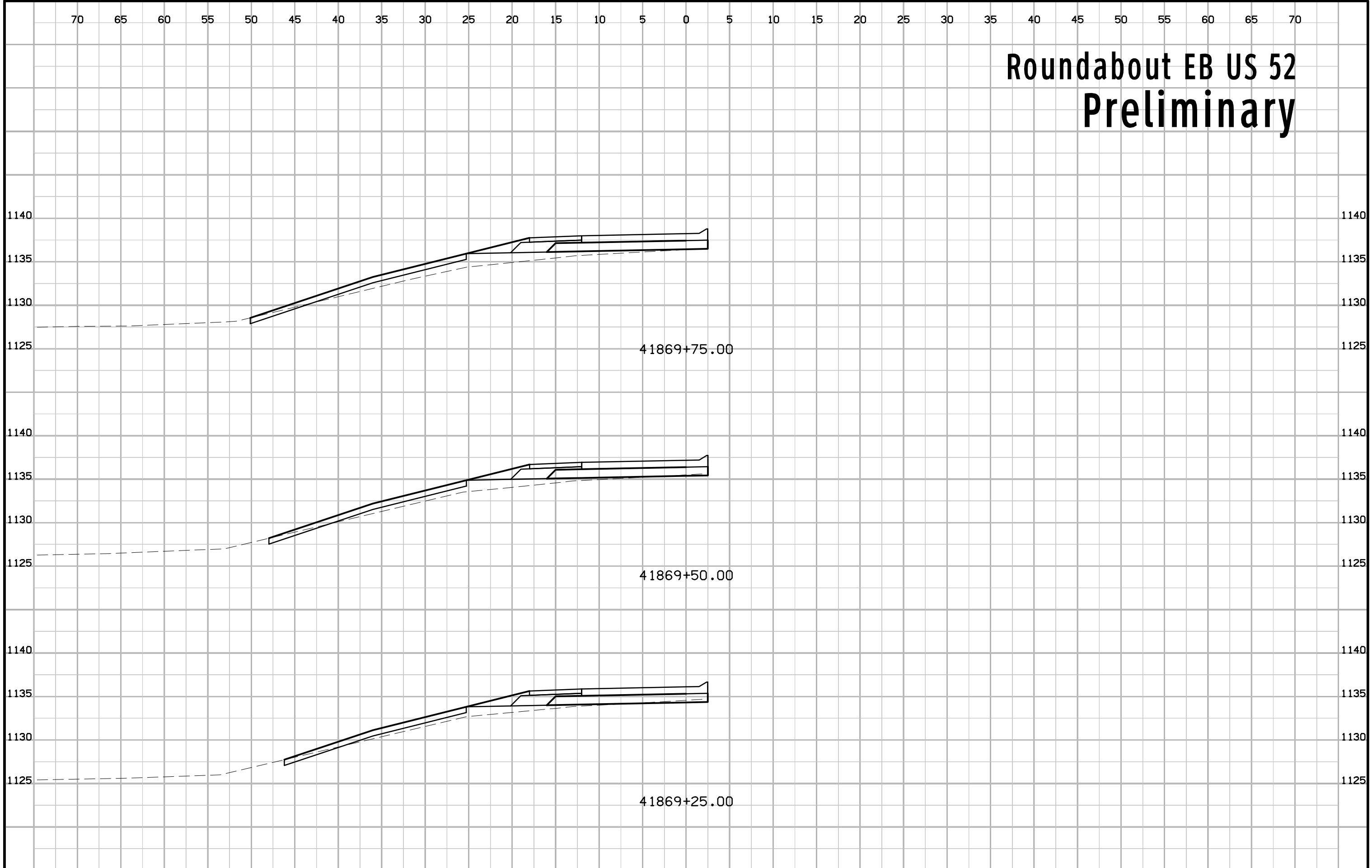

# Roundabout EB US 52 Preliminary

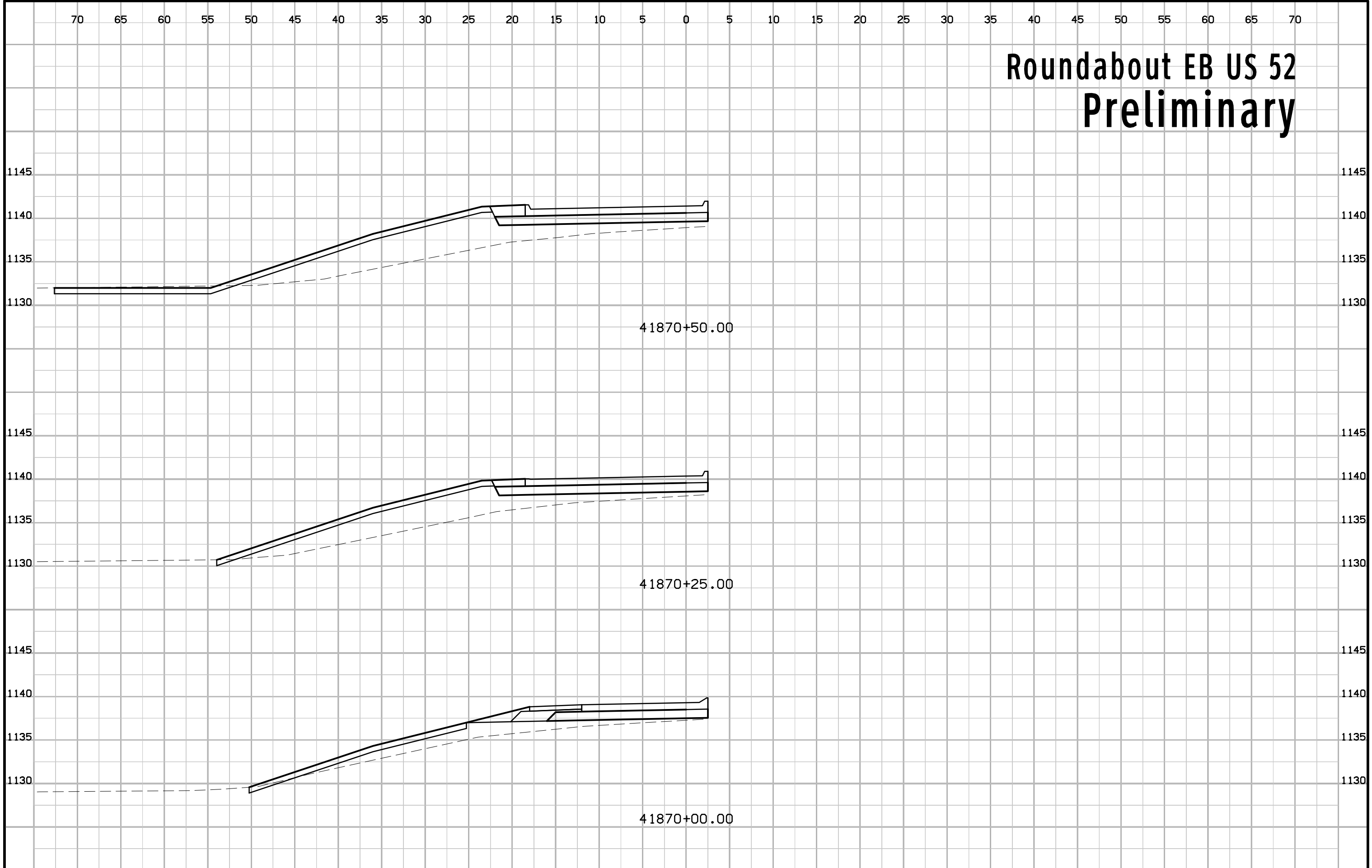



# Roundabout EB US 52 Preliminary

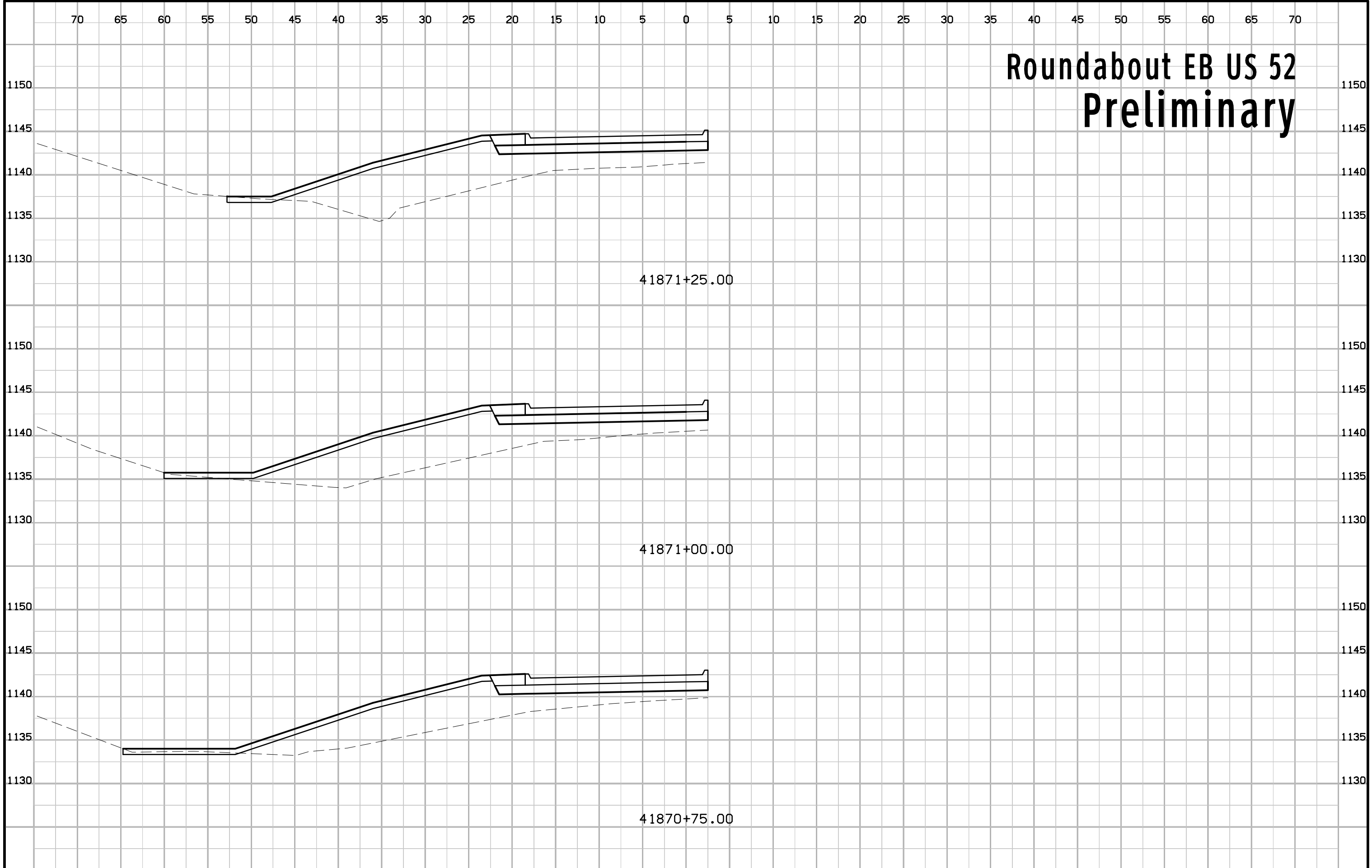

# Roundabout EB US 52 Preliminary

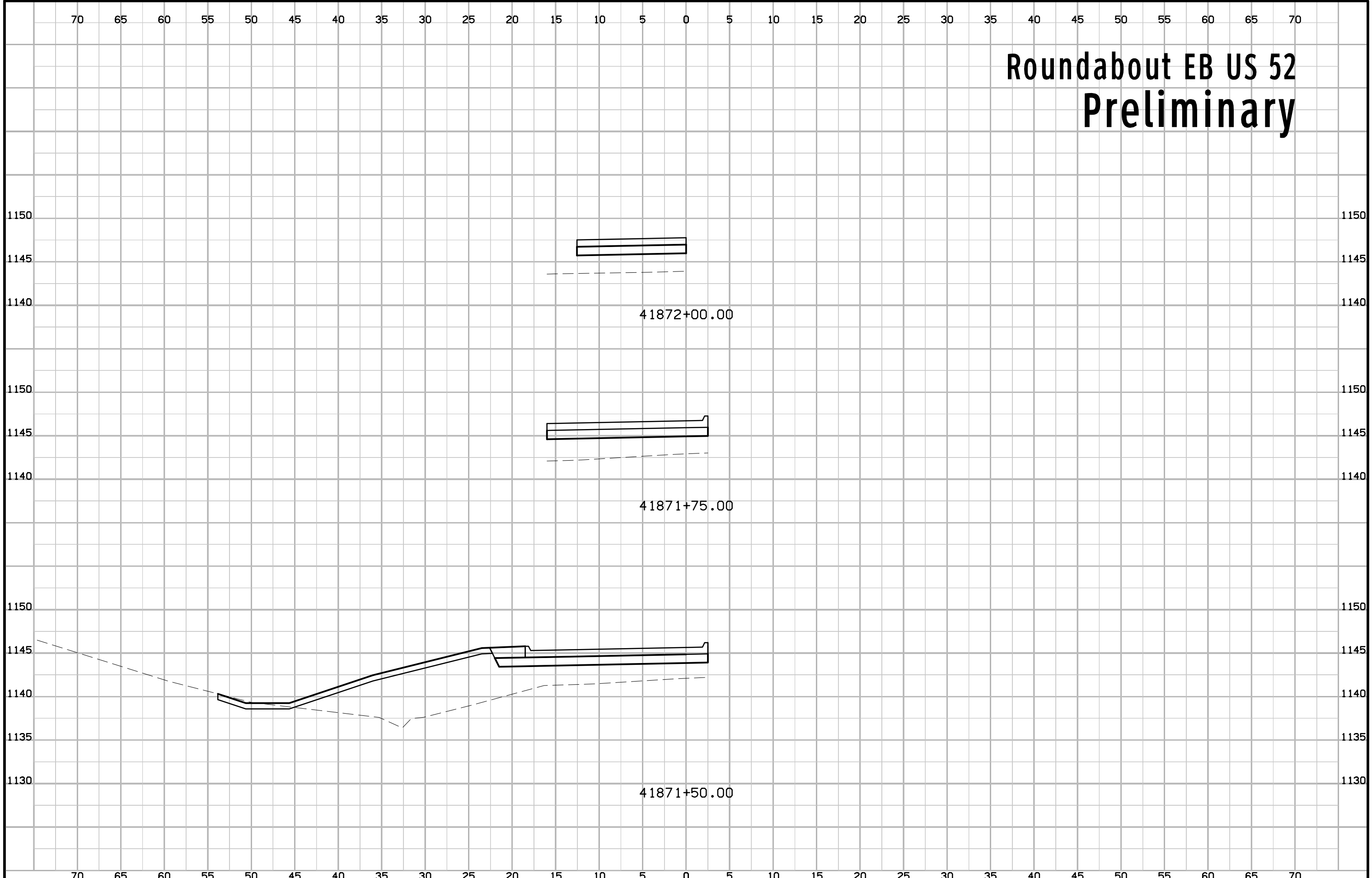

# Roundabout EB US 52 Preliminary

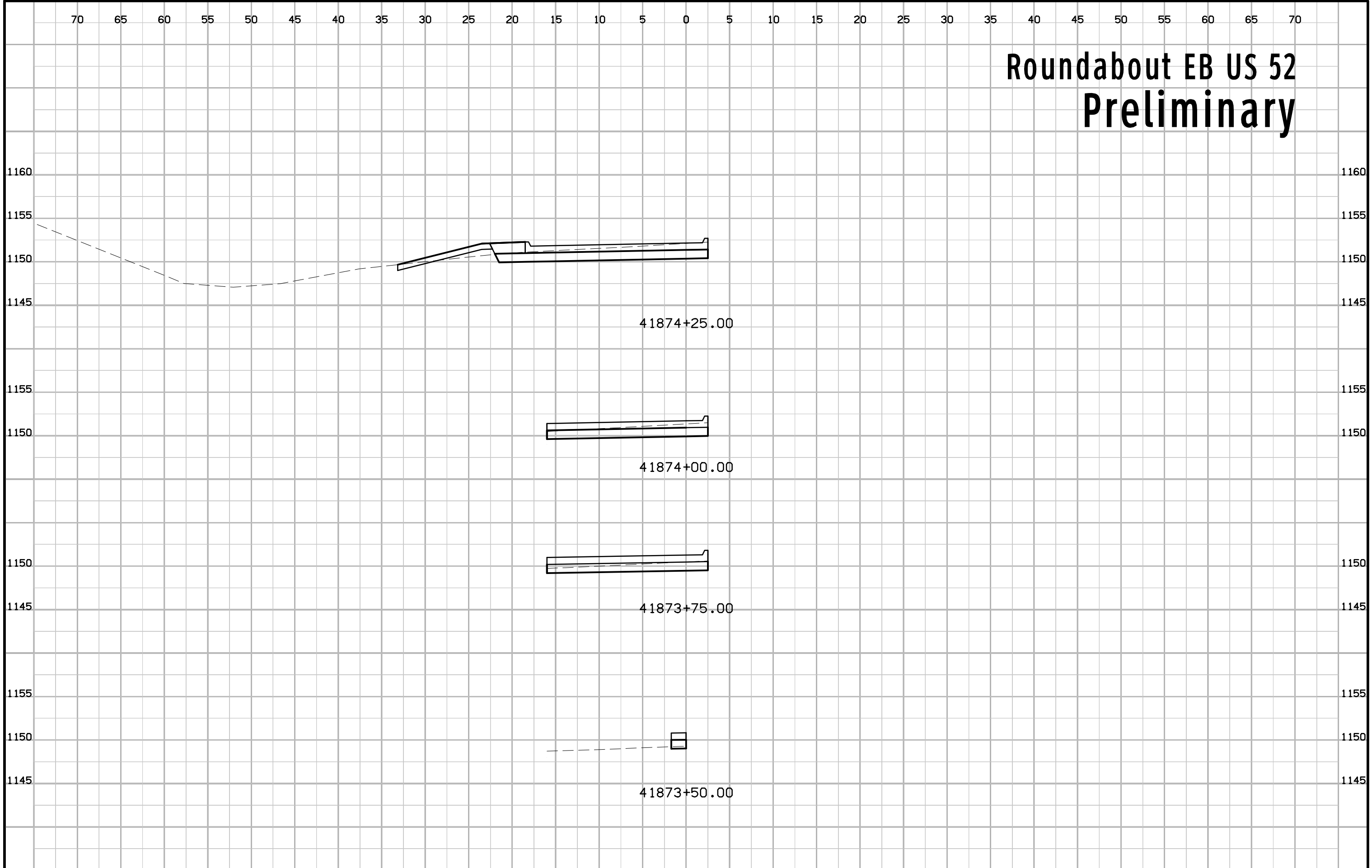

# Roundabout EB US 52 Preliminary

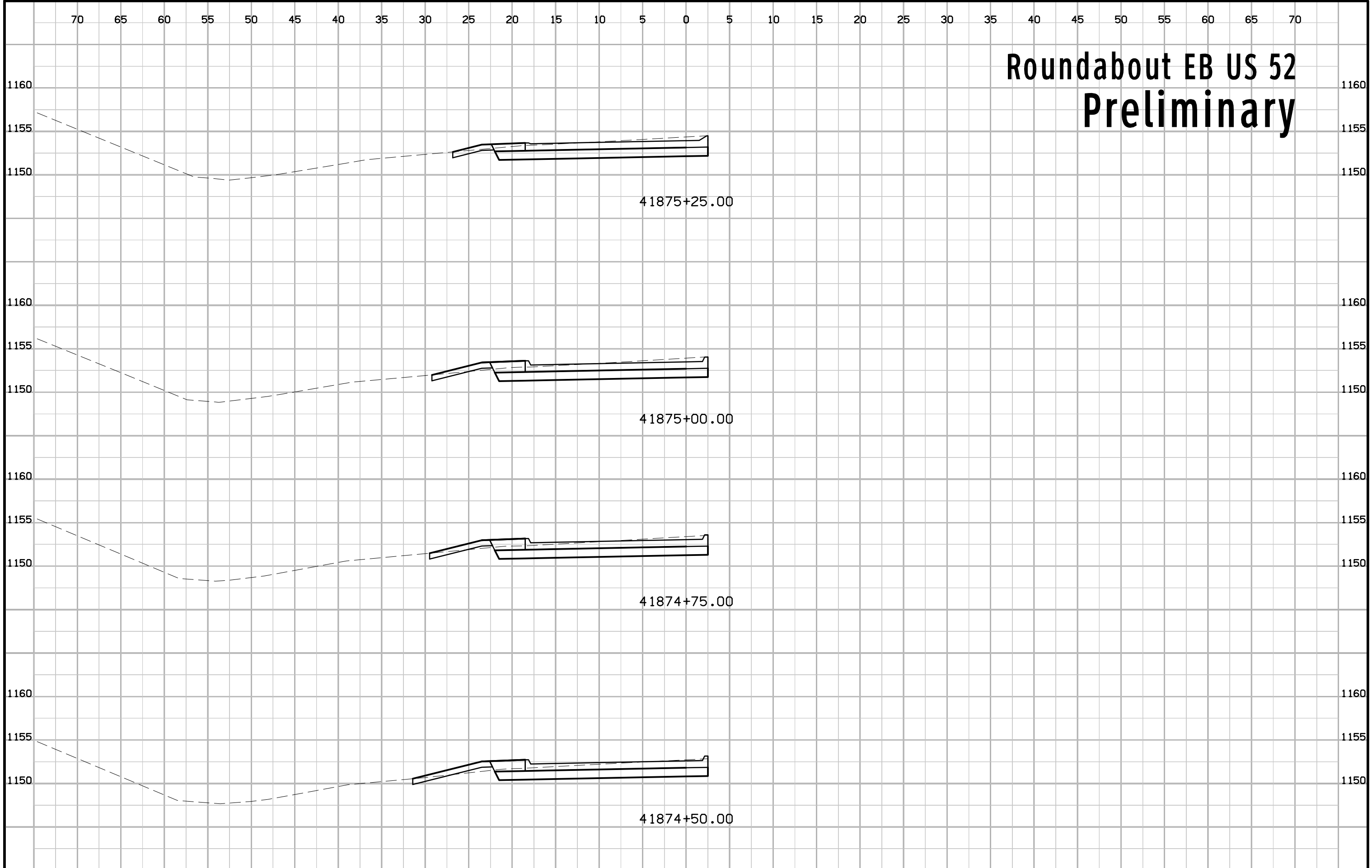

# Roundabout EB US 52 Preliminary

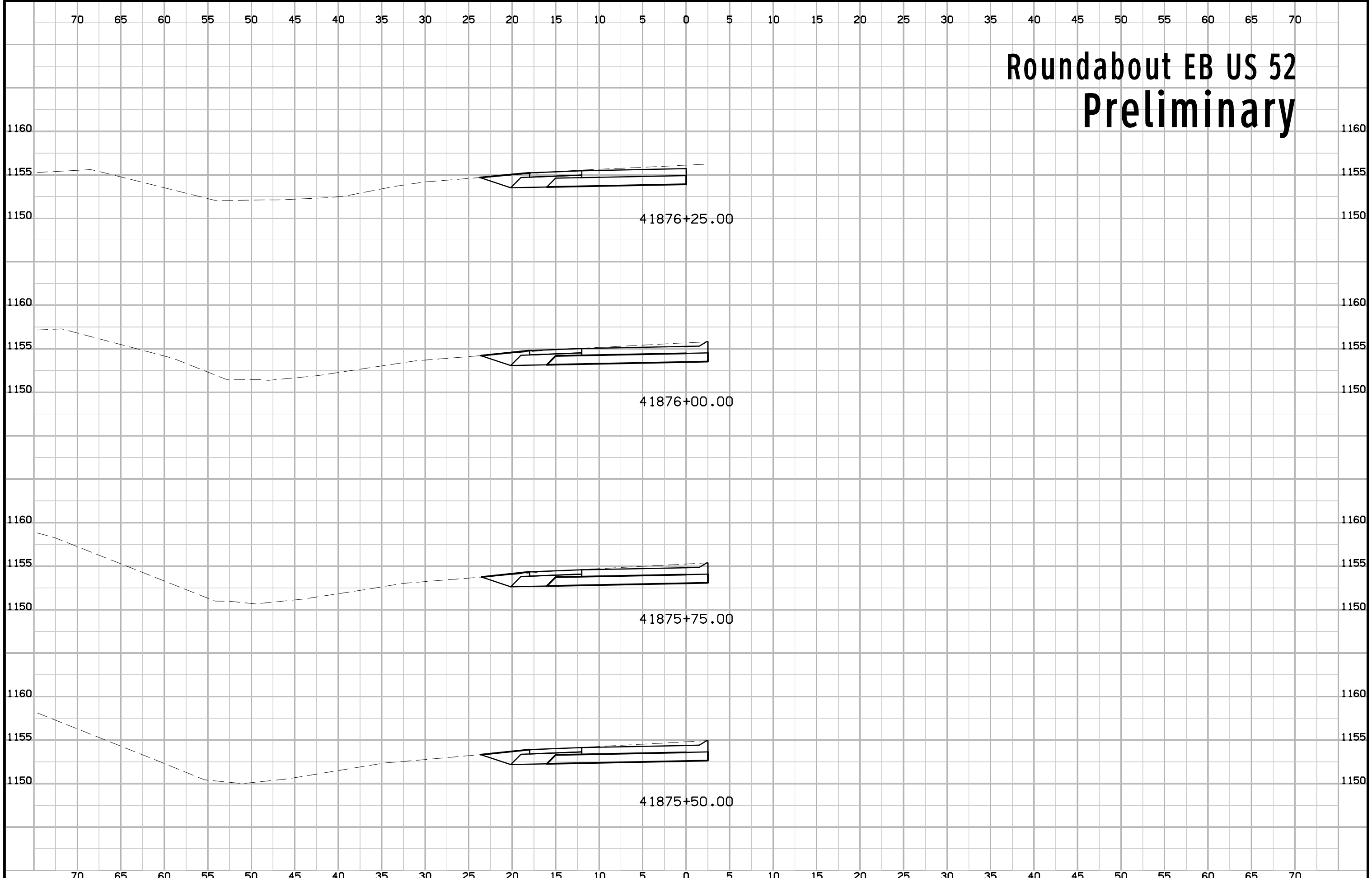

# Roundabout EB US 52 Preliminary

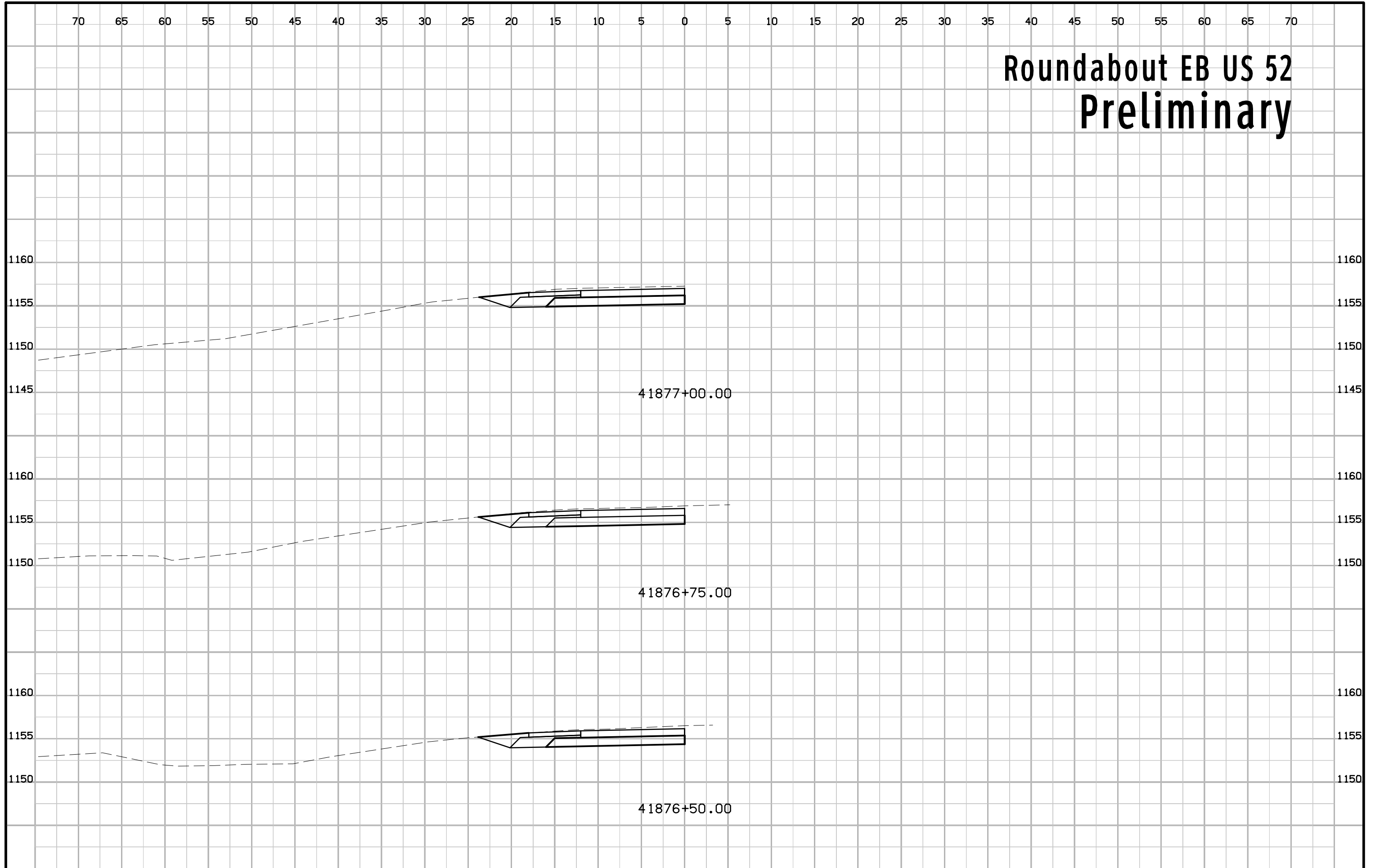

# Roundabout EB US 52 Preliminary

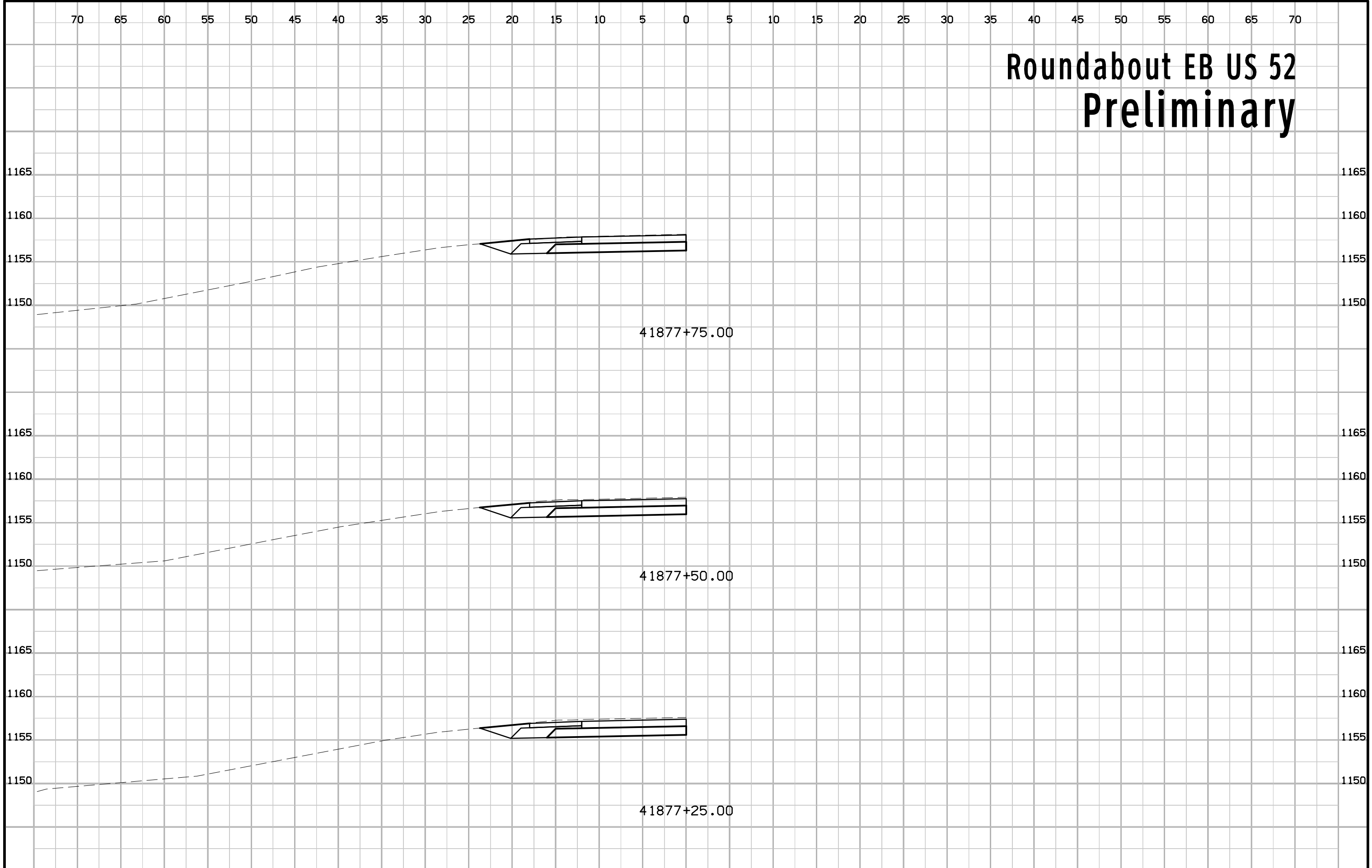

# Roundabout EB US 52 Preliminary

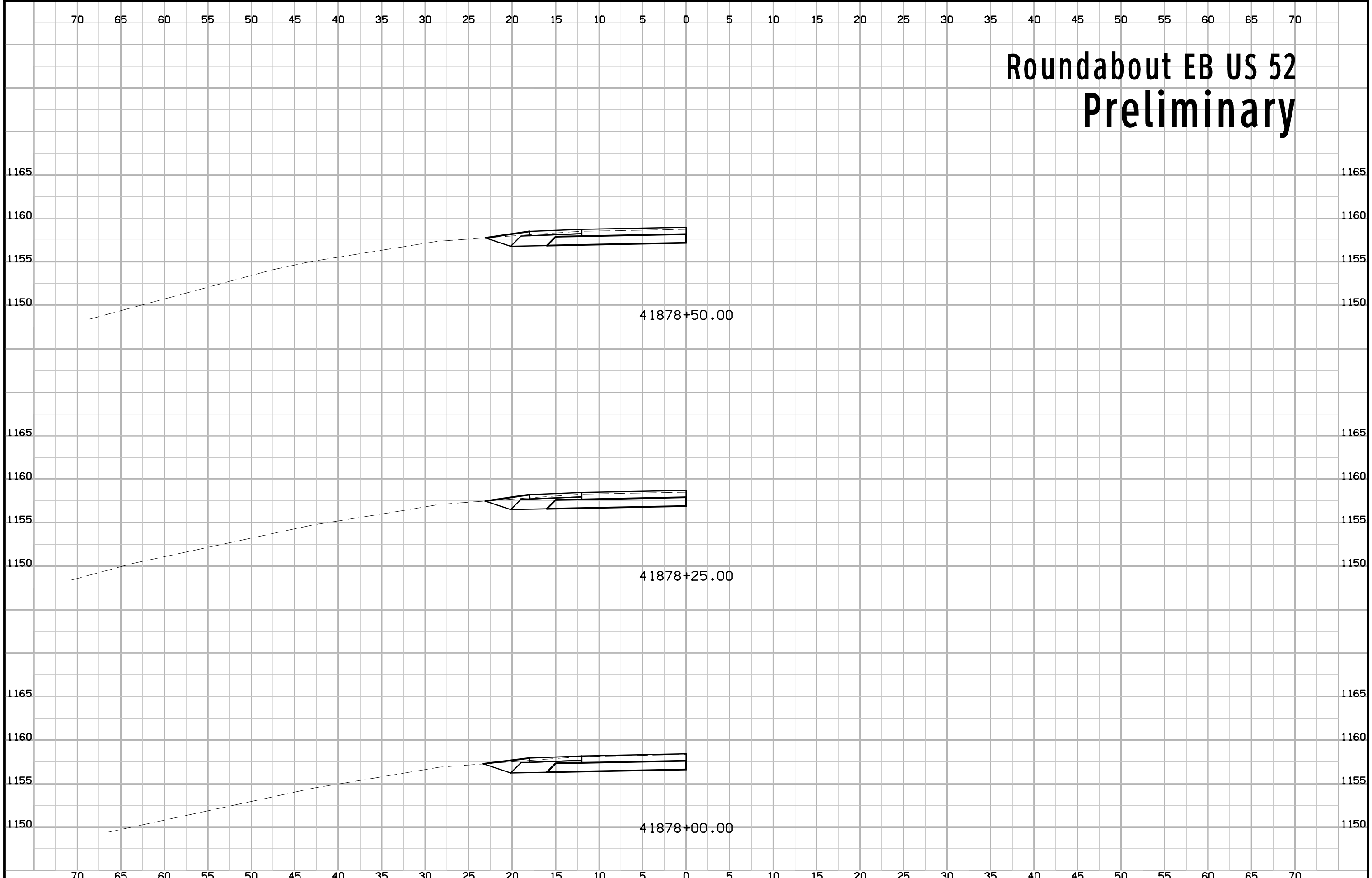



# Roundabout EB US 52 Preliminary

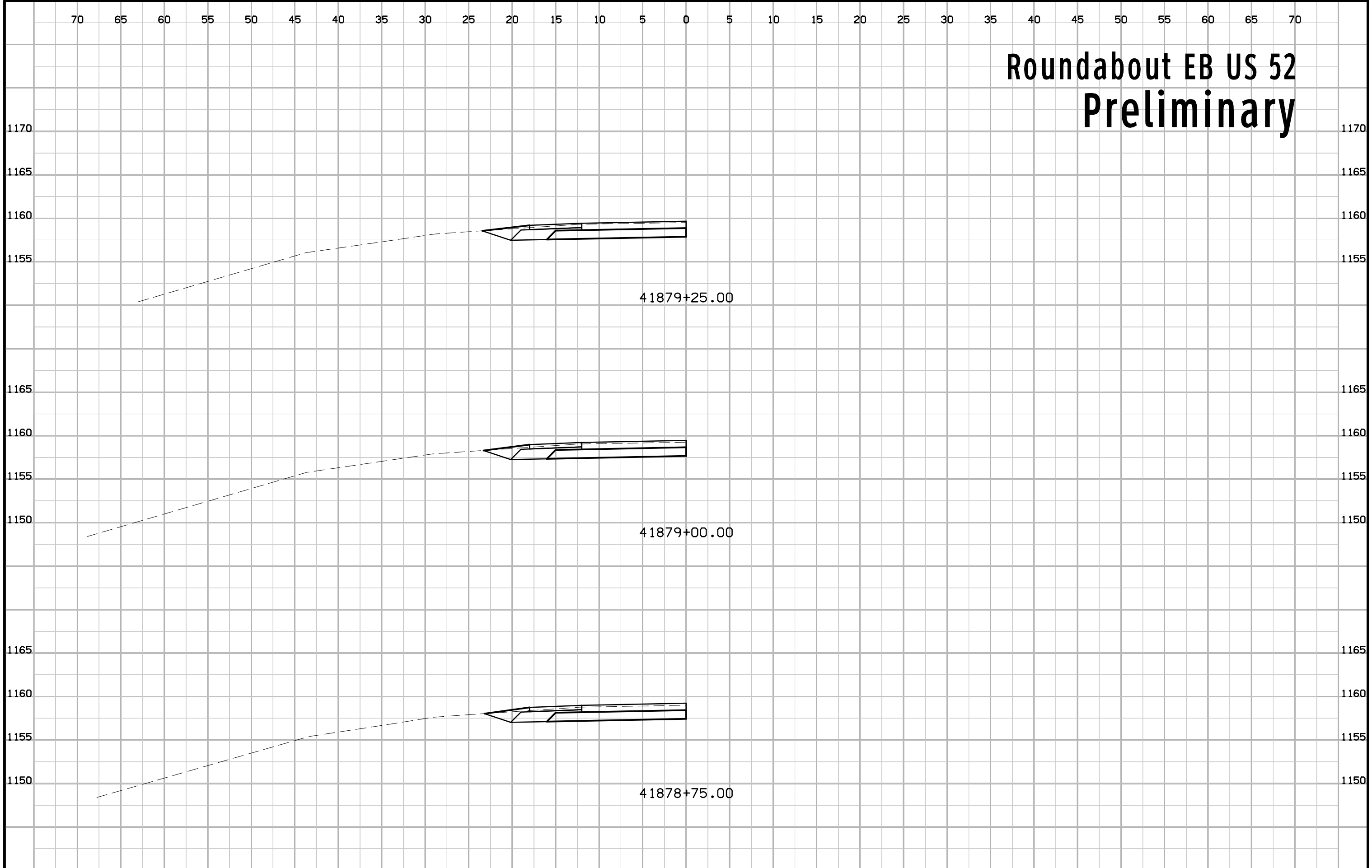

# Roundabout EB US 52 Preliminary

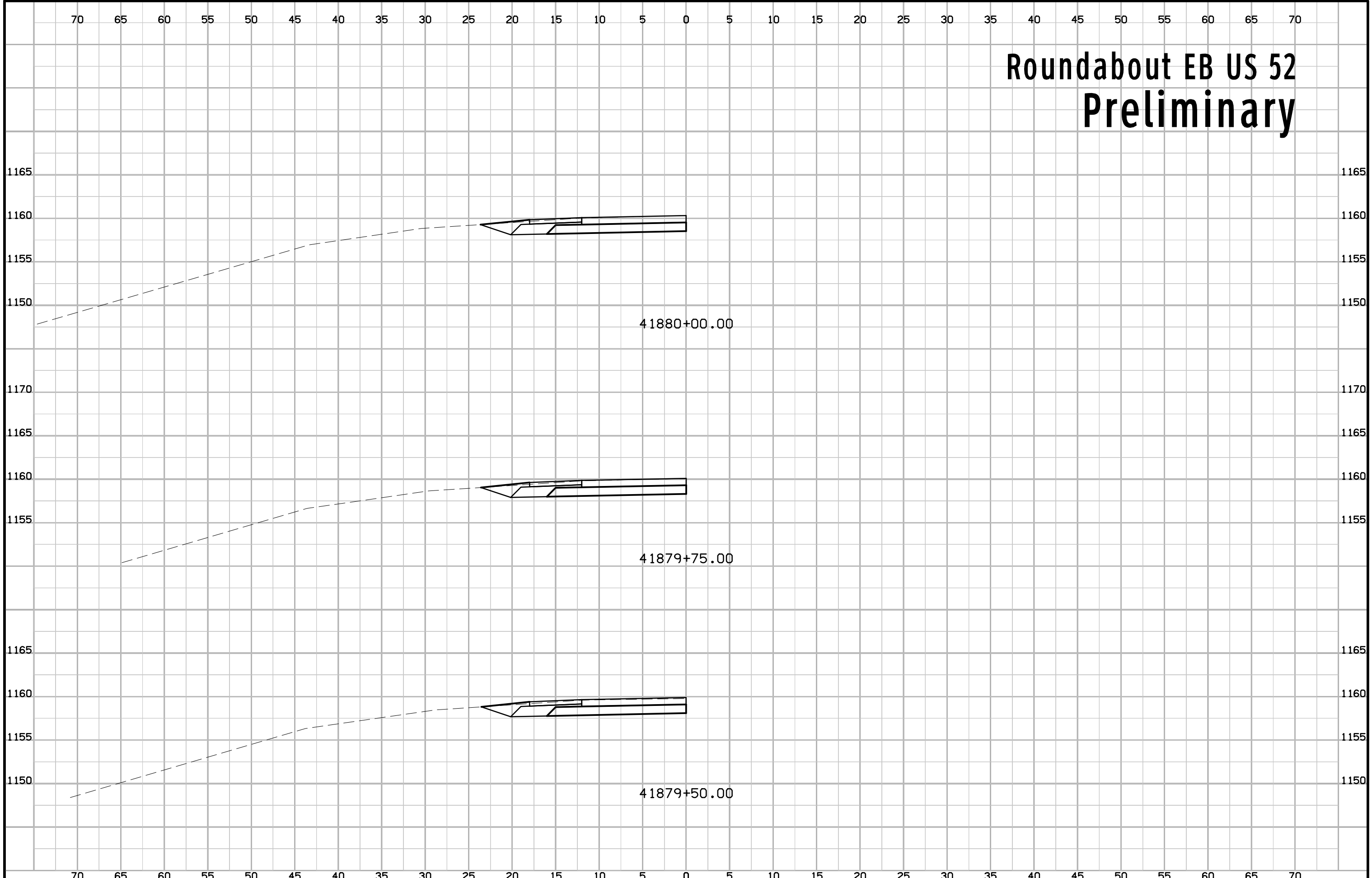

# Roundabout EB US 52 Preliminary

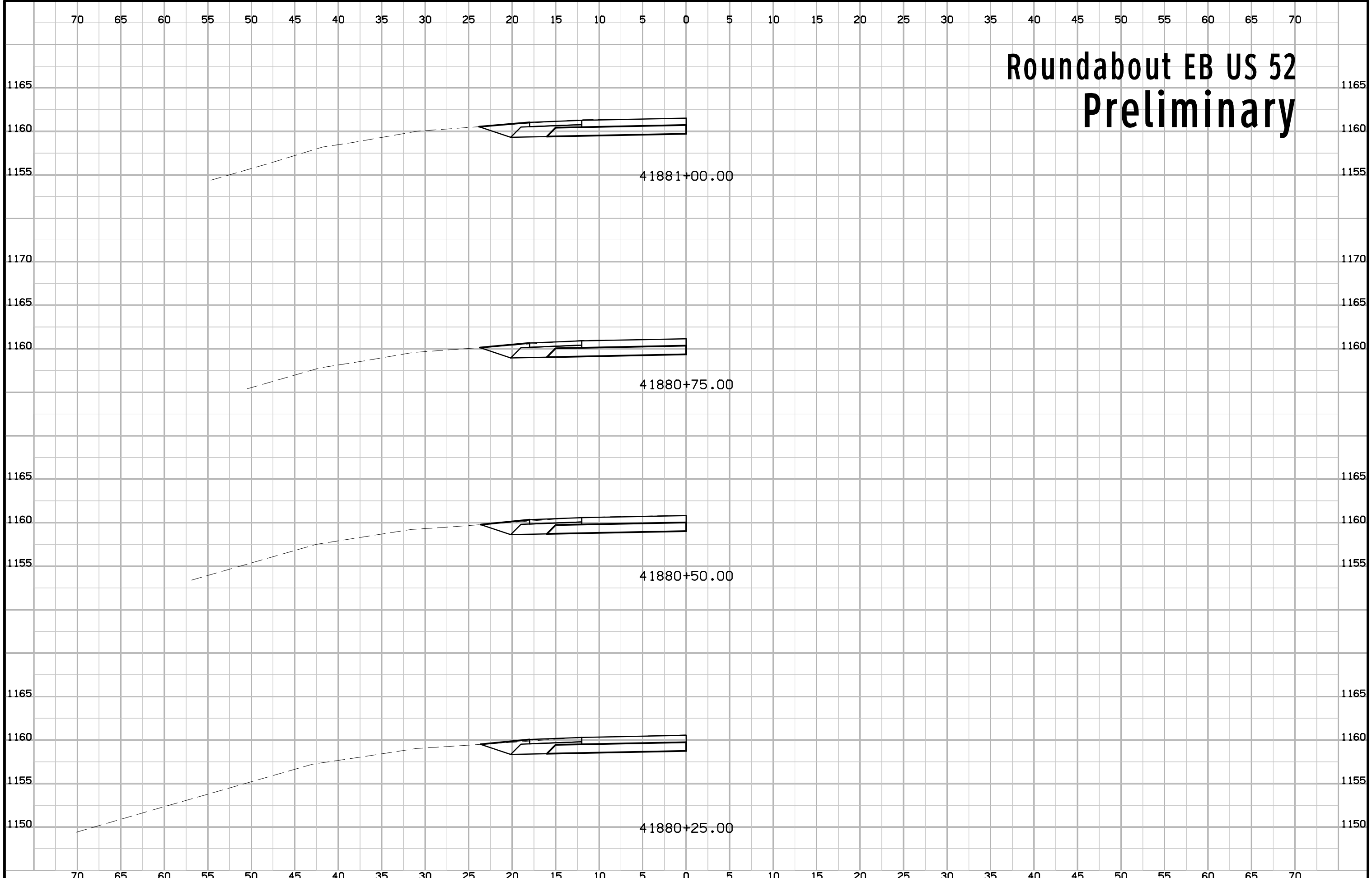

# Roundabout EB US 52 Preliminary

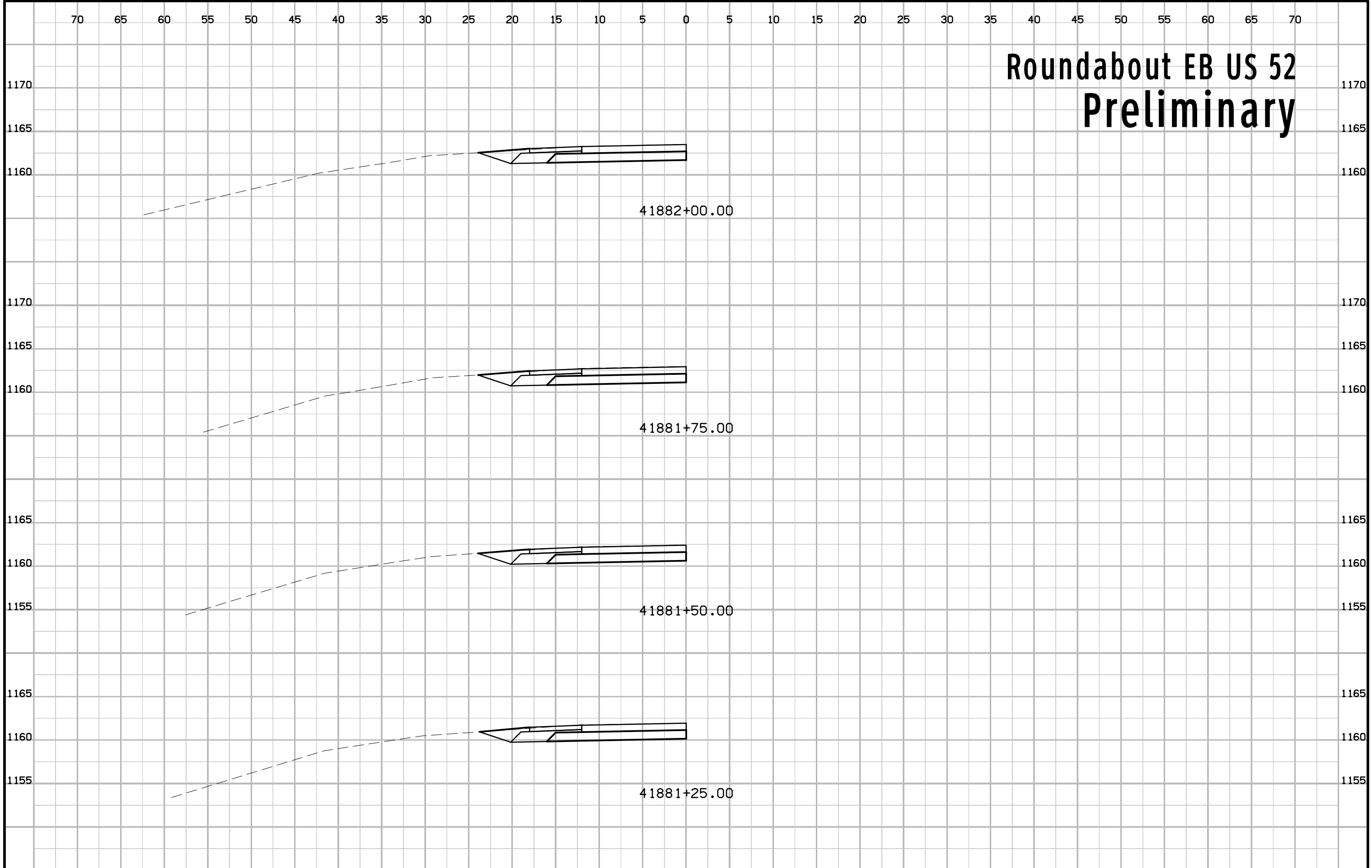

# Roundabout EB US 52 Preliminary

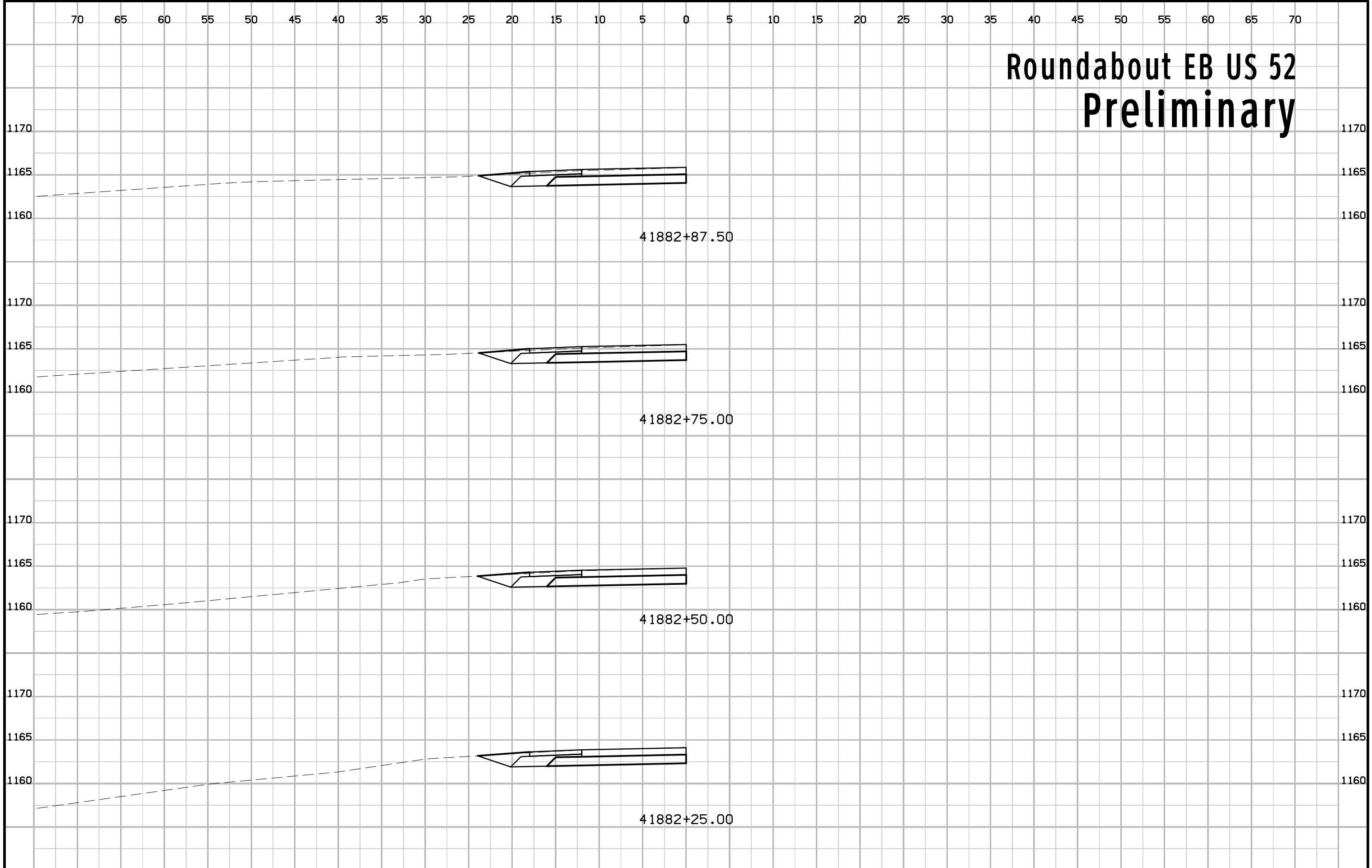

# Roundabout EB US 52 Preliminary

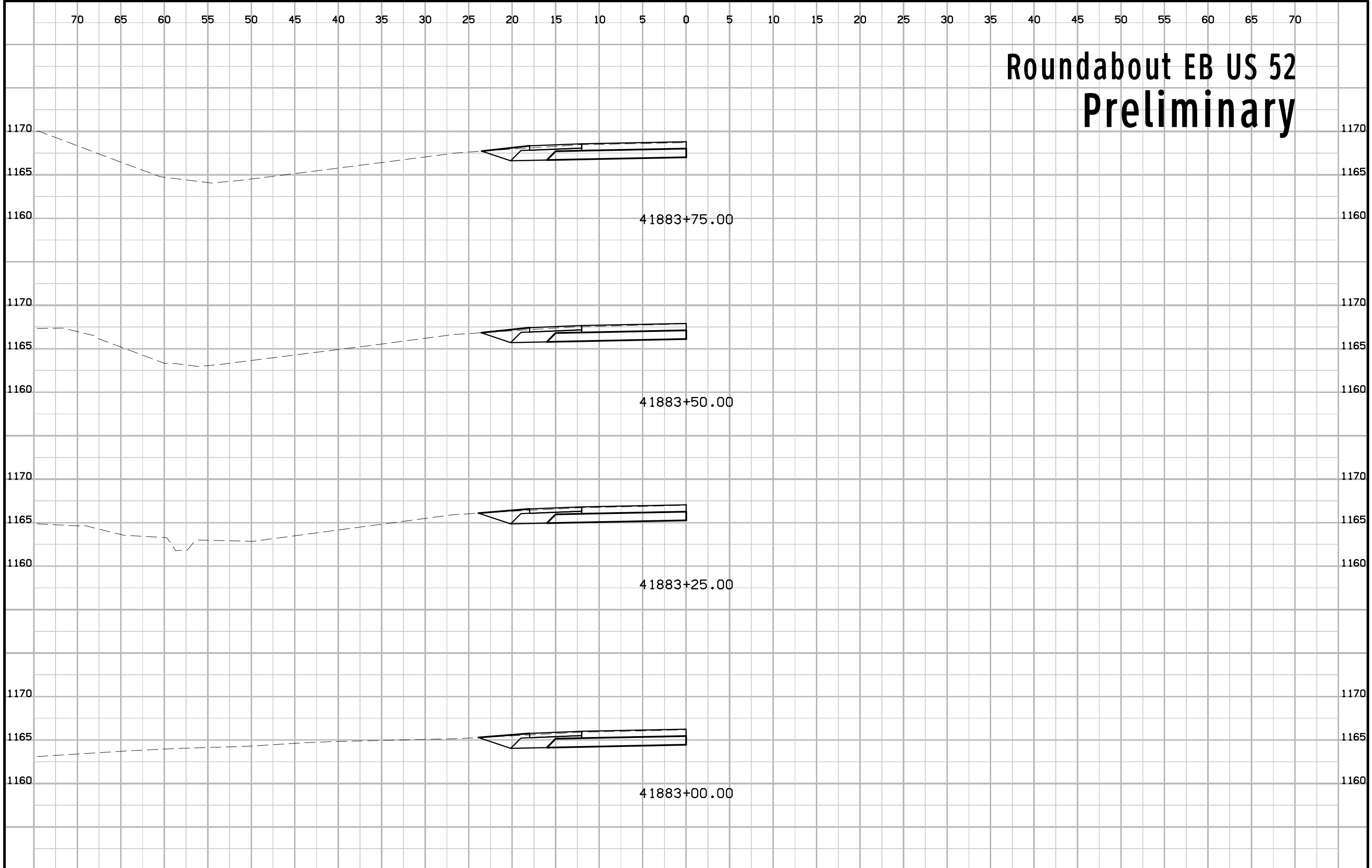

# Roundabout EB US 52 Preliminary

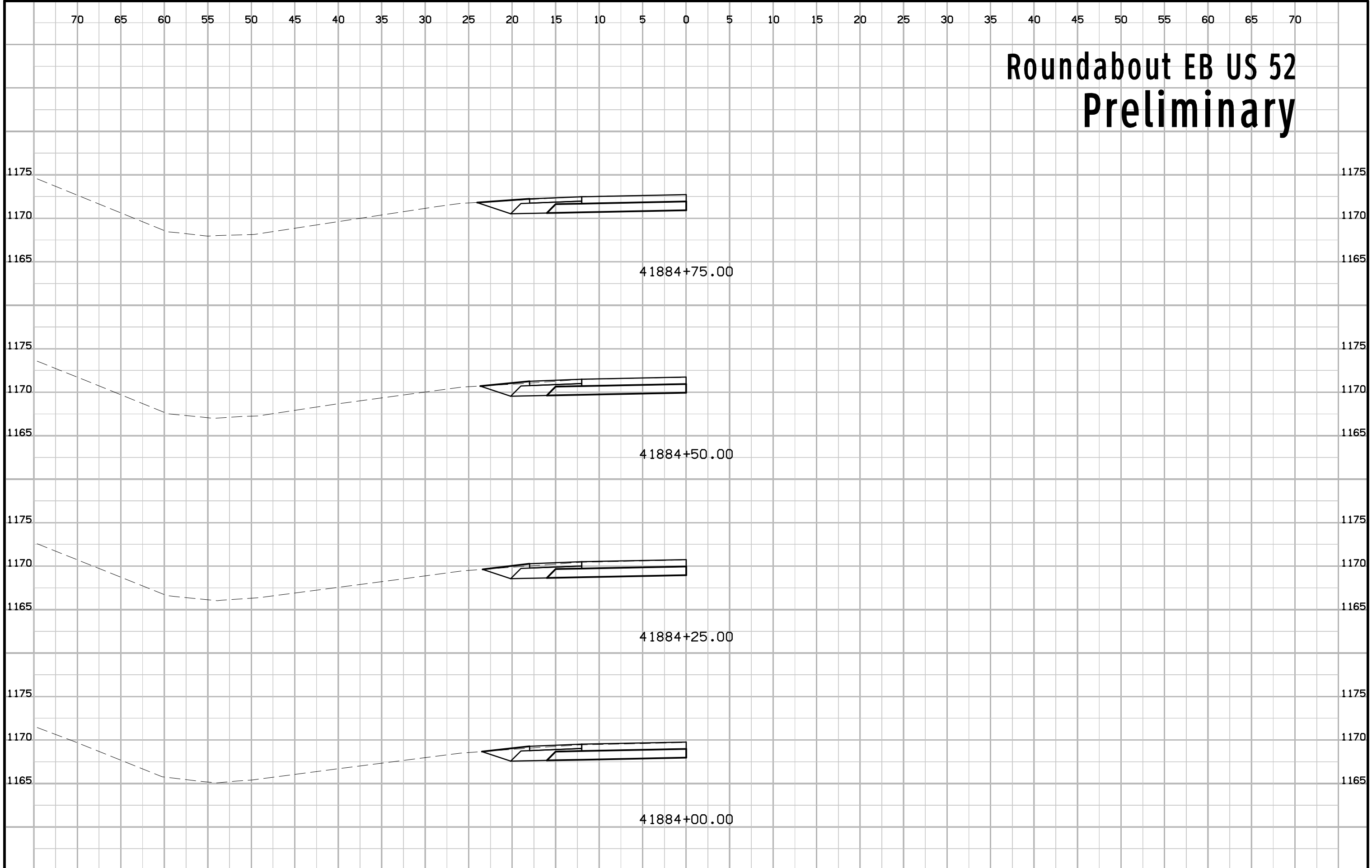

# Roundabout EB US 52 Preliminary

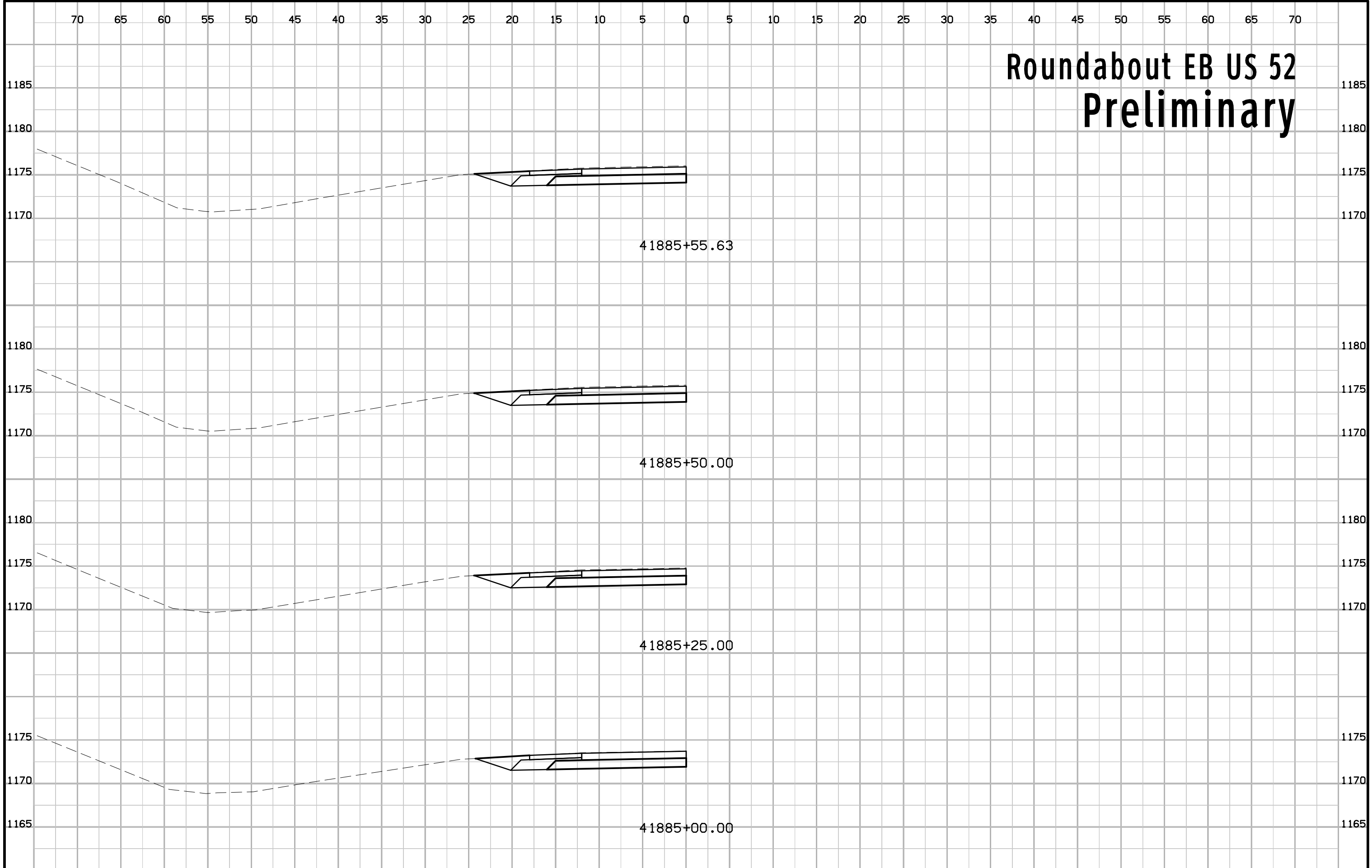



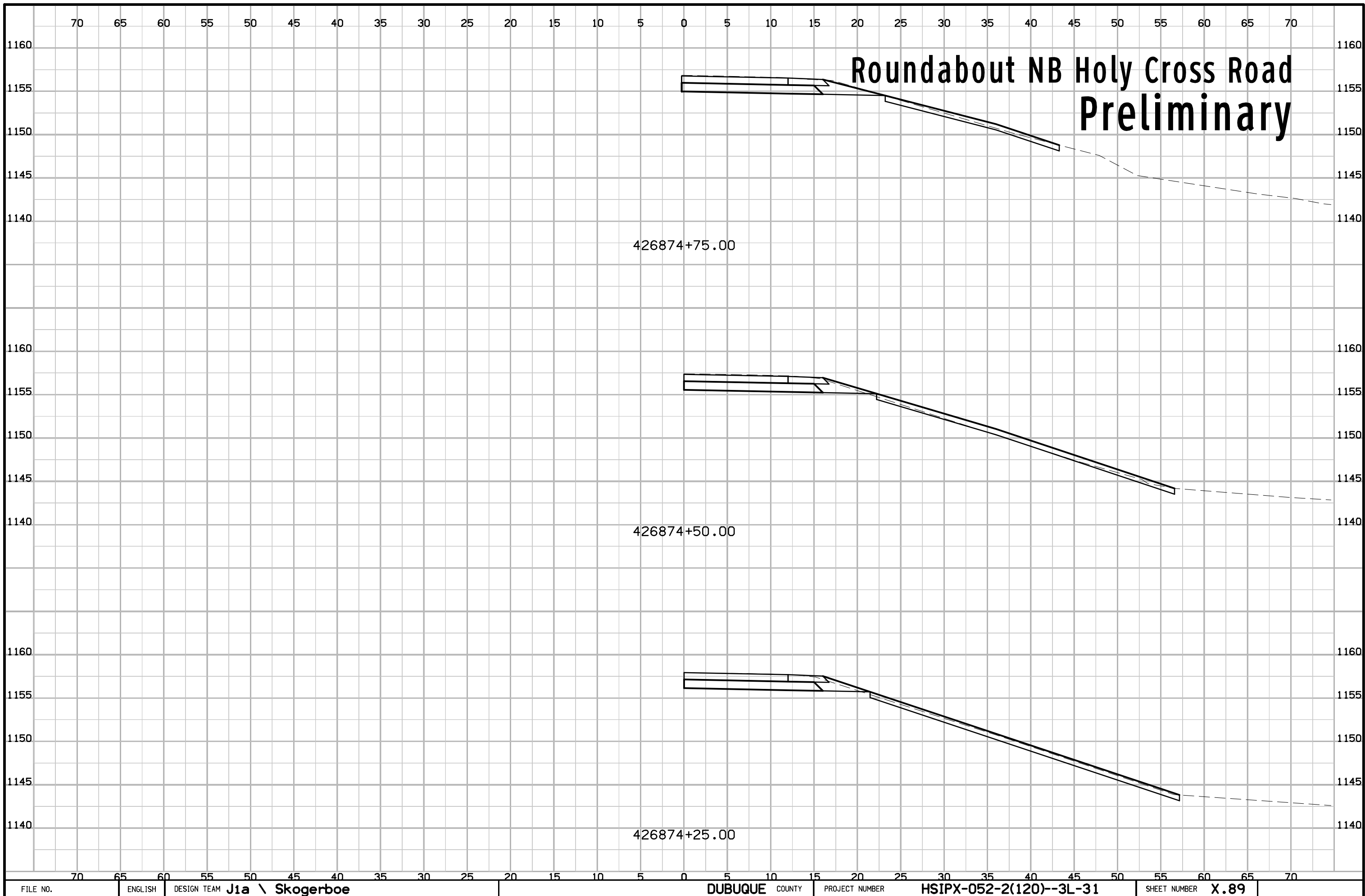

70 65 60 55 50 45 40 35 30 25 20 15 10 5 0 5 10 15 20 25 30 35 40 45 50 55 60 65 70

# Roundabout NB Holy Cross Road Preliminary

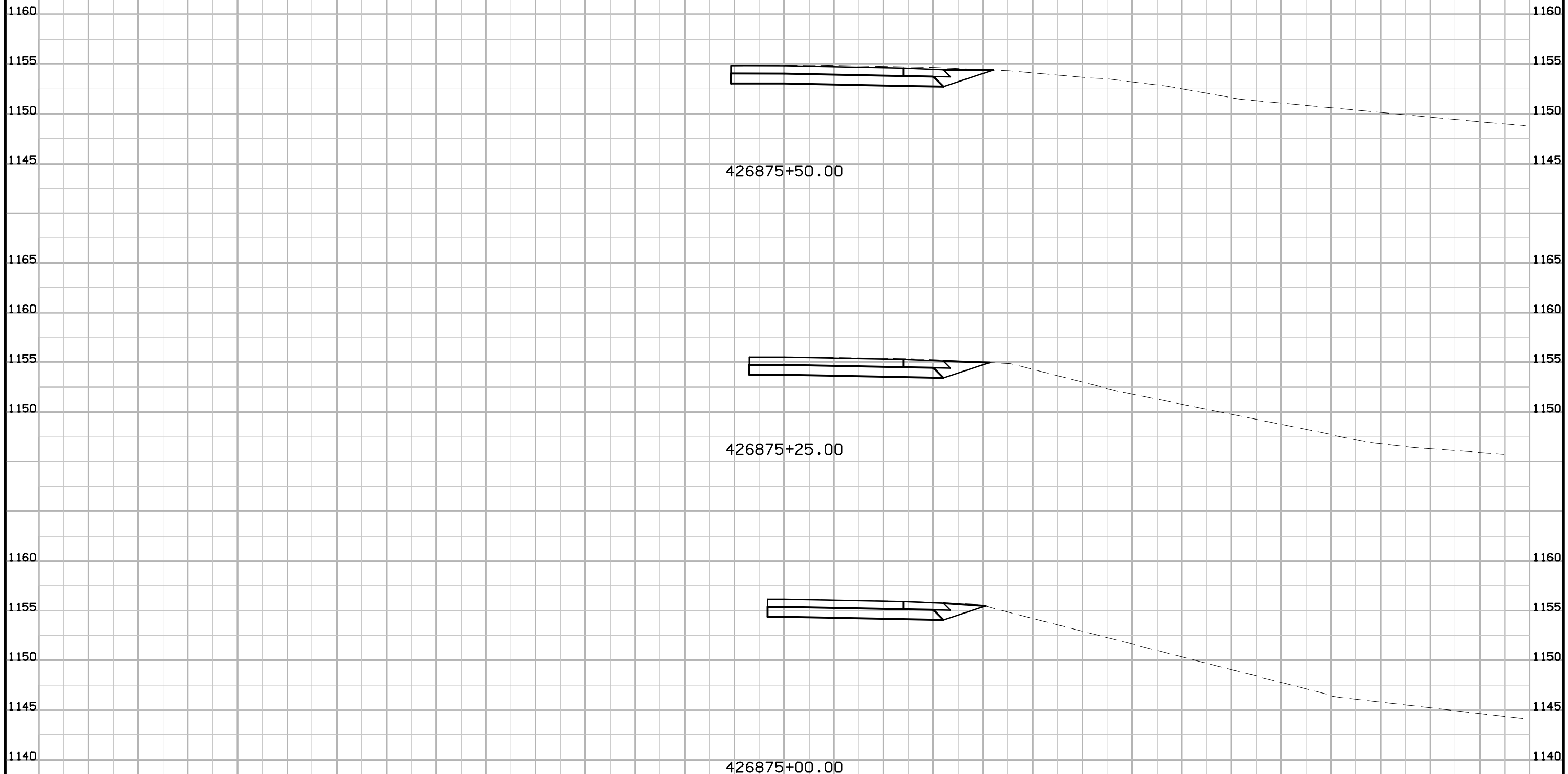

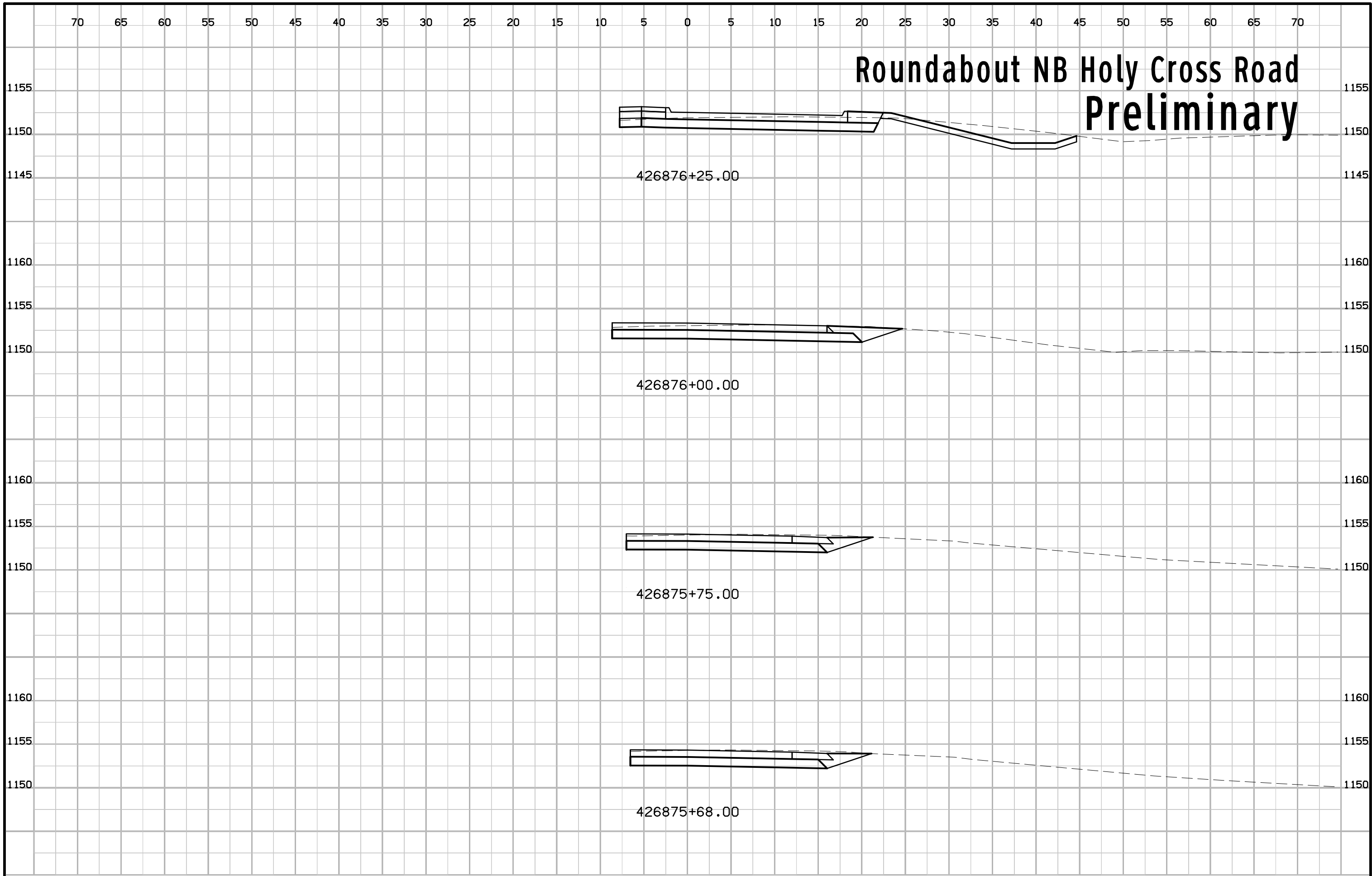

70 65 60 55 50 45 40 35 30 25 20 15 10 5 0 5 10 15 20 25 30 35 40 45 50 55 60 65 70

# Roundabout NB Holy Cross Road Preliminary

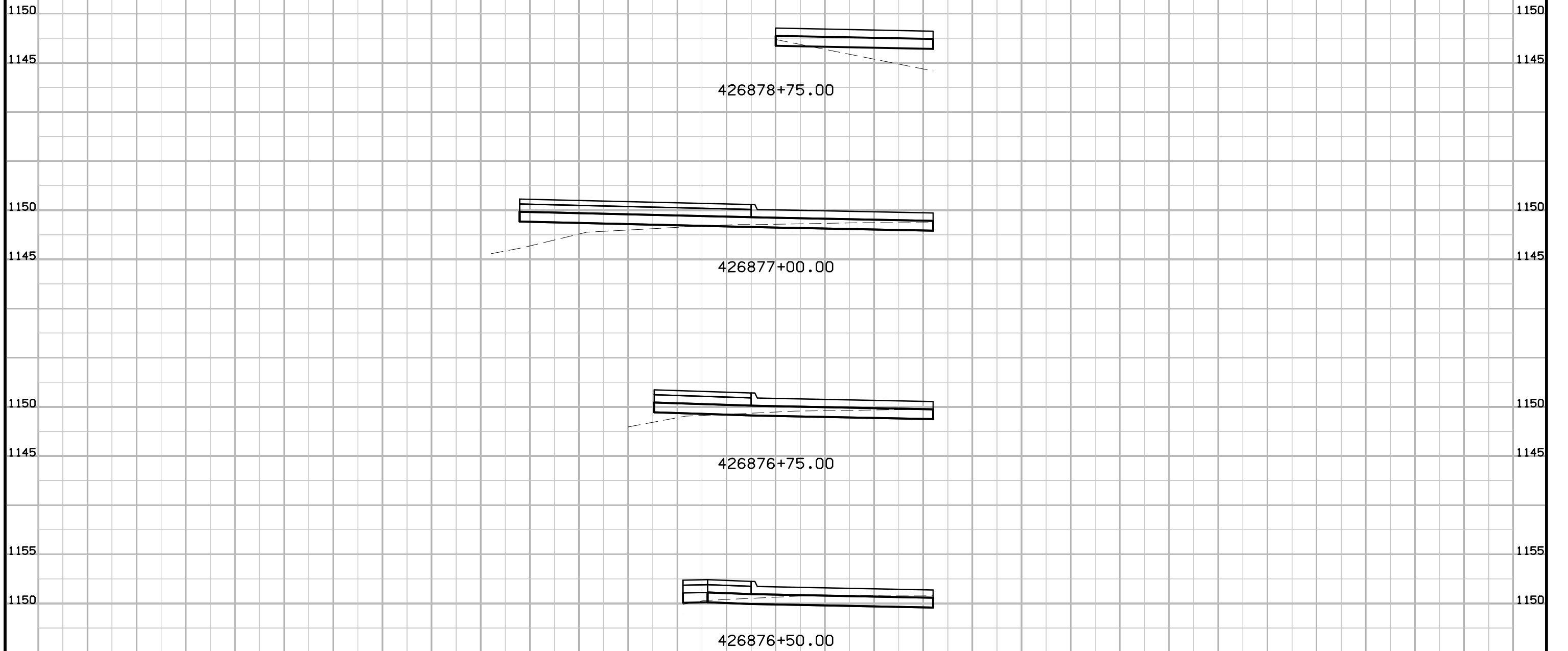

# Roundabout NB Holy Cross Road Preliminary

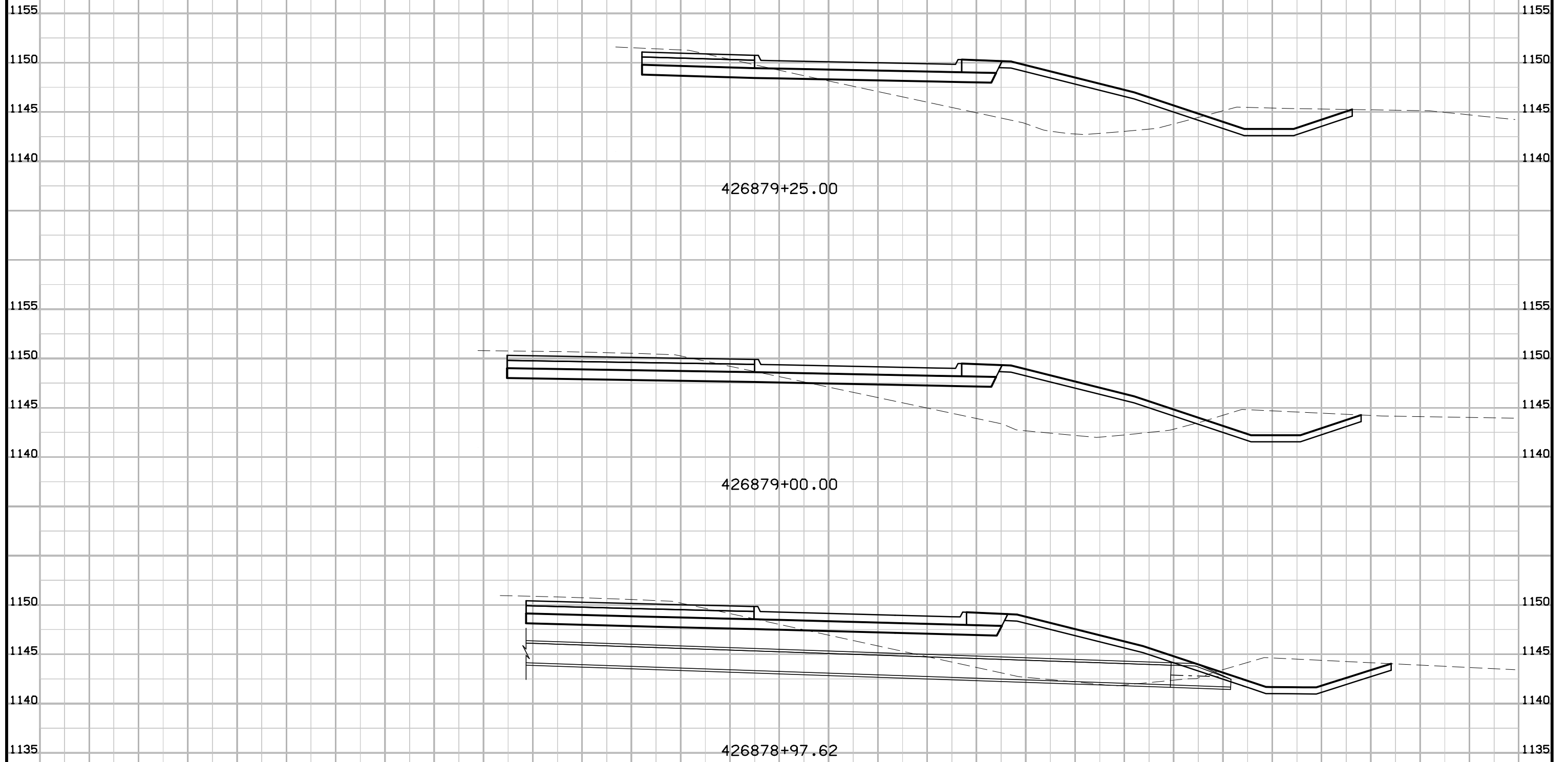

# Roundabout NB Holy Cross Road Preliminary

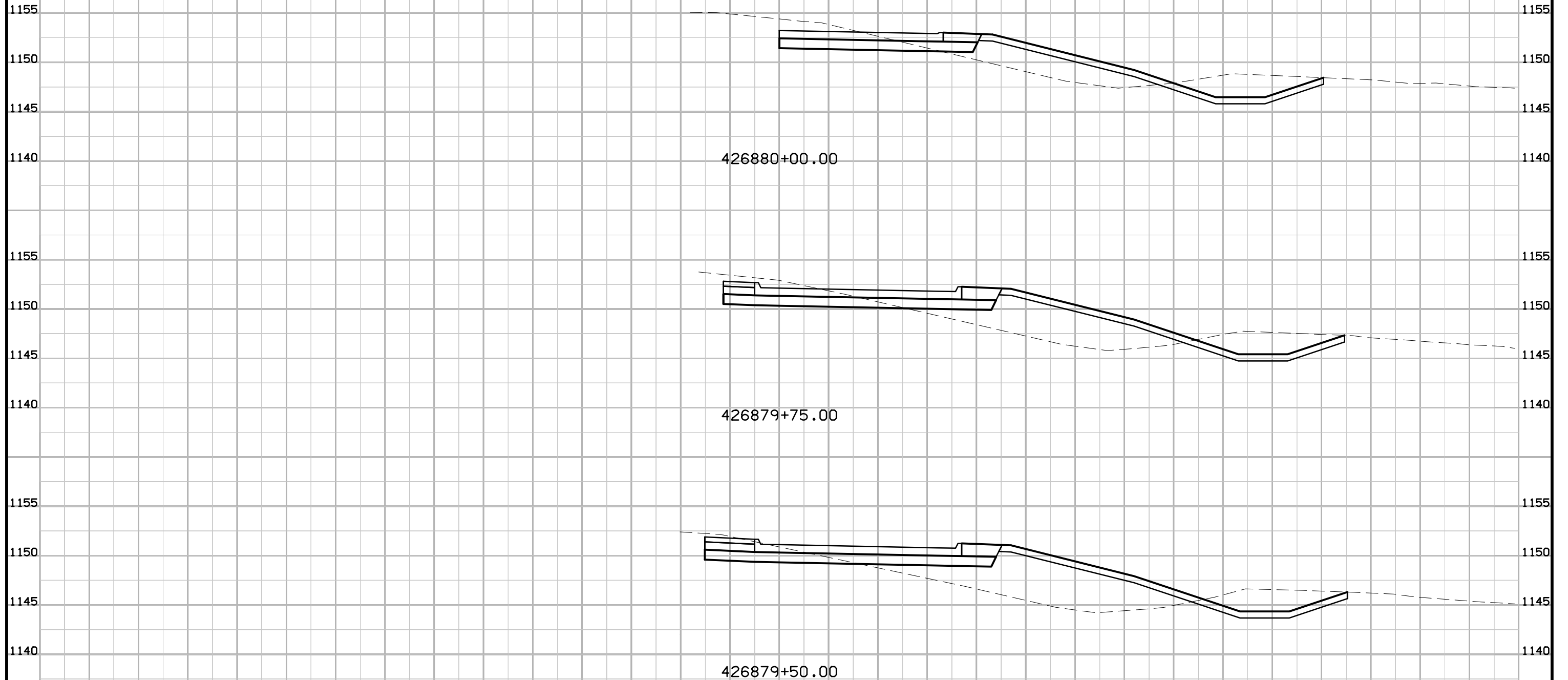

# Roundabout NB Holy Cross Road Preliminary

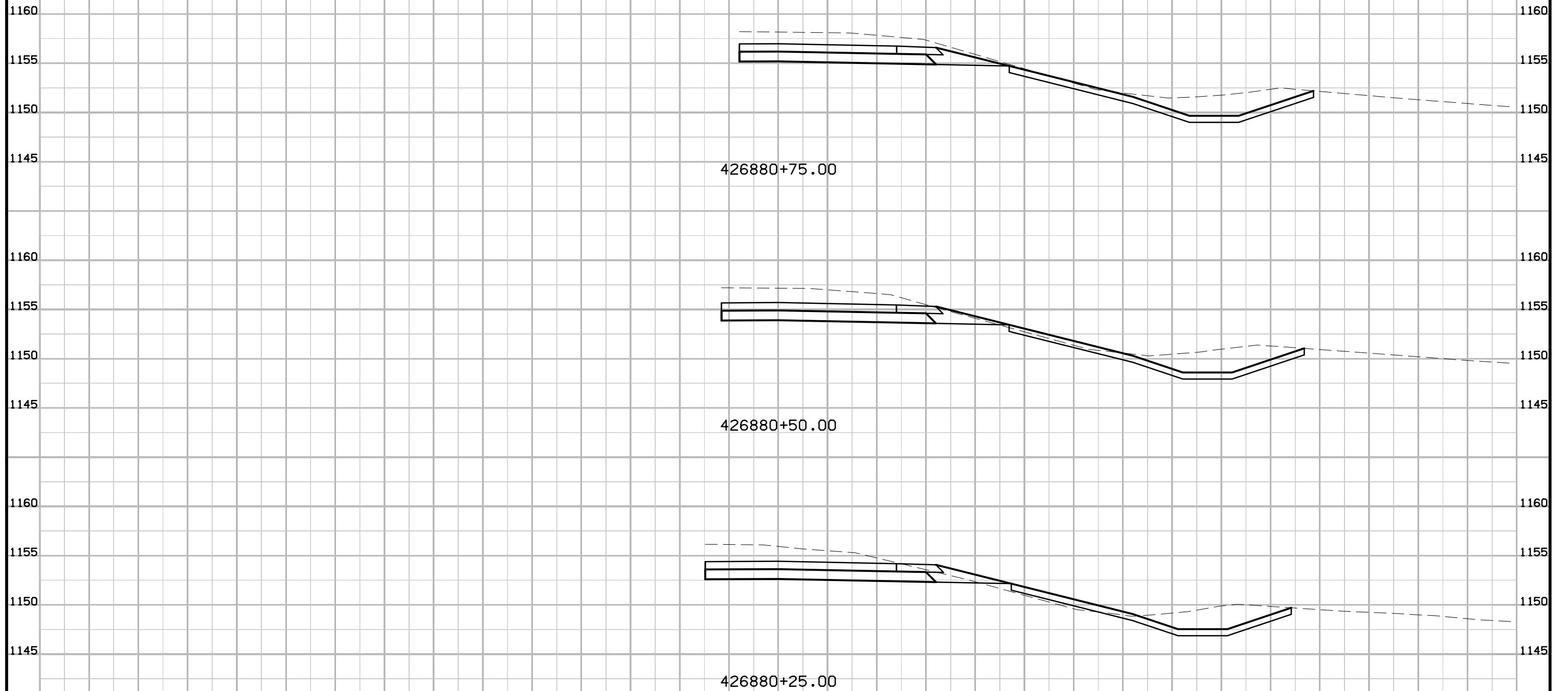

# Roundabout NB Holy Cross Road Preliminary

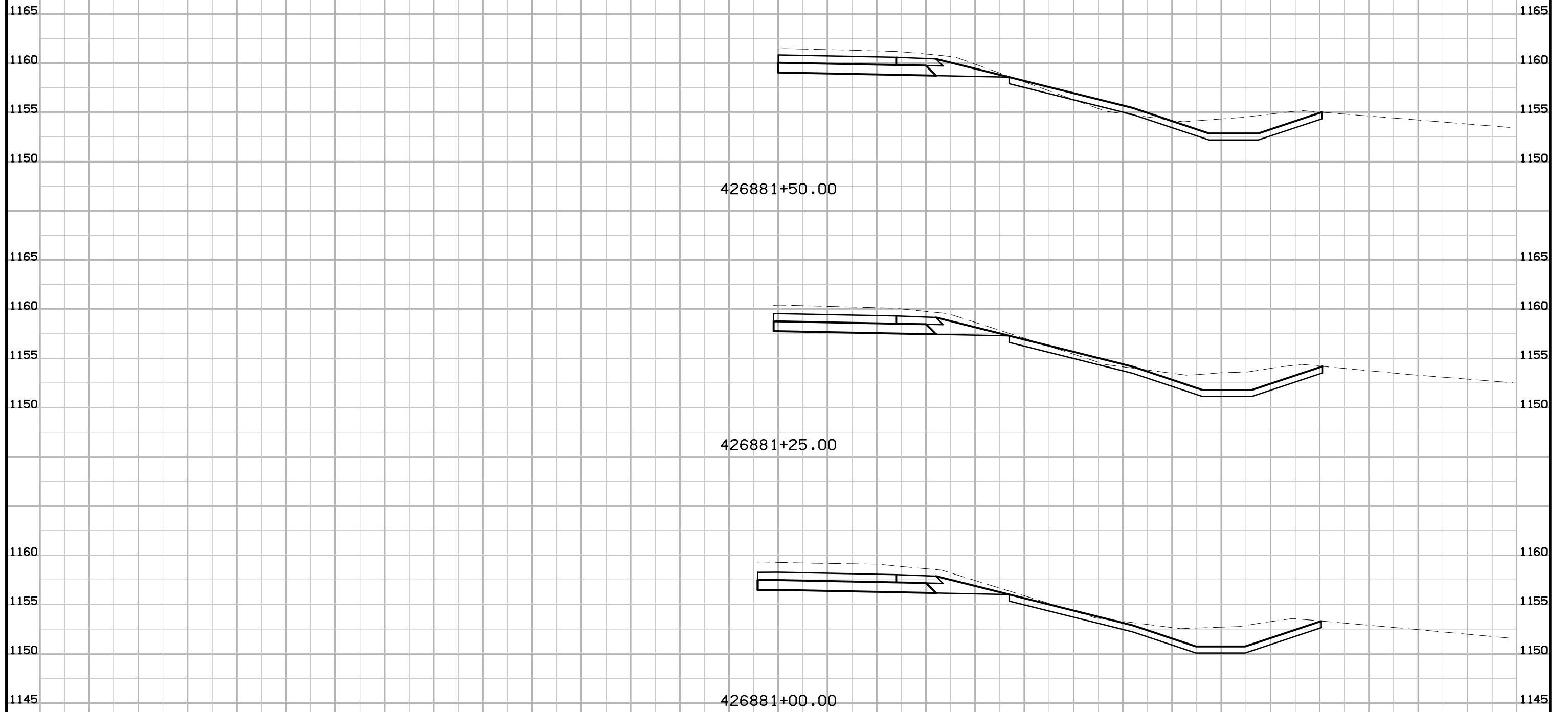



# Roundabout NB Holy Cross Road Preliminary

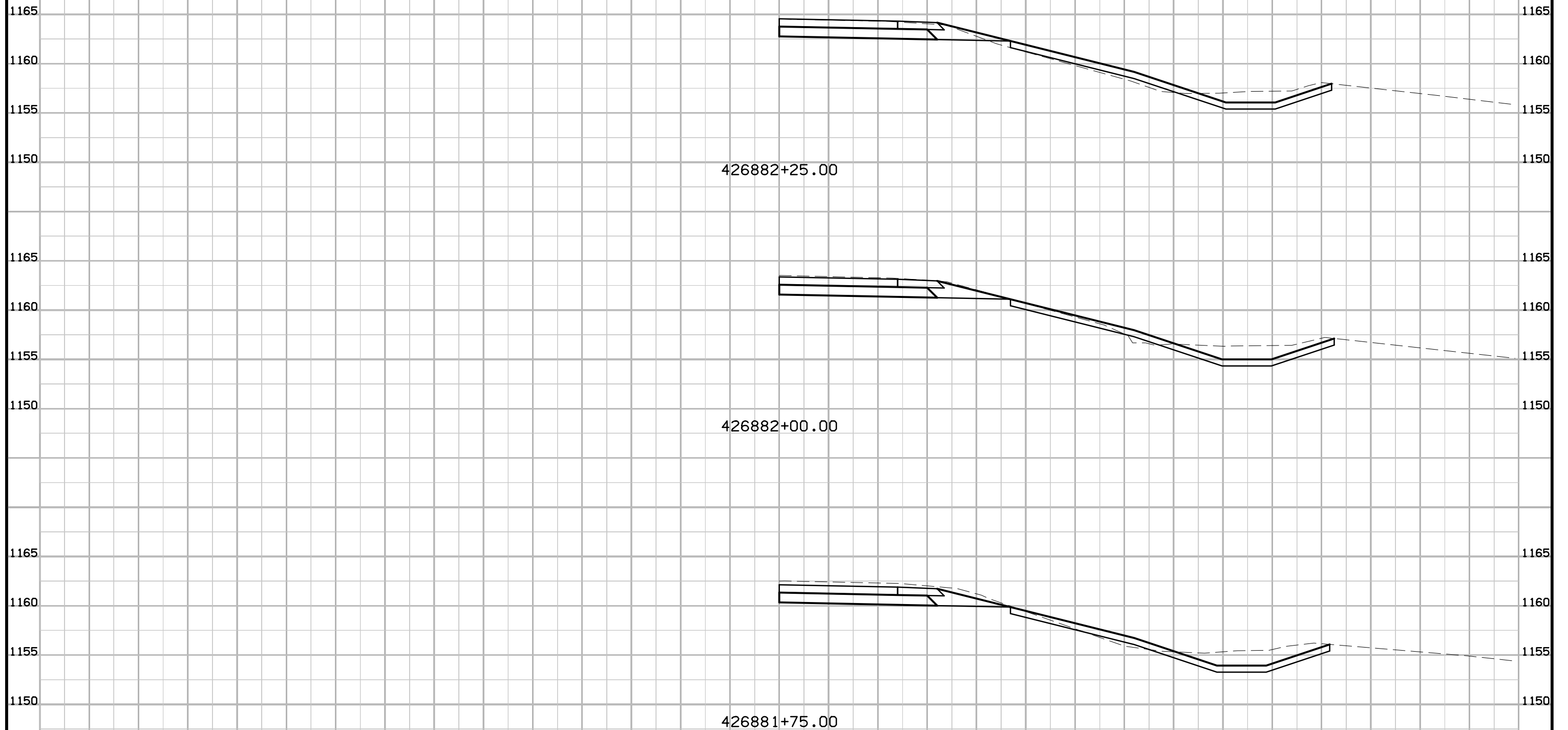

# Roundabout NB Holy Cross Road Preliminary

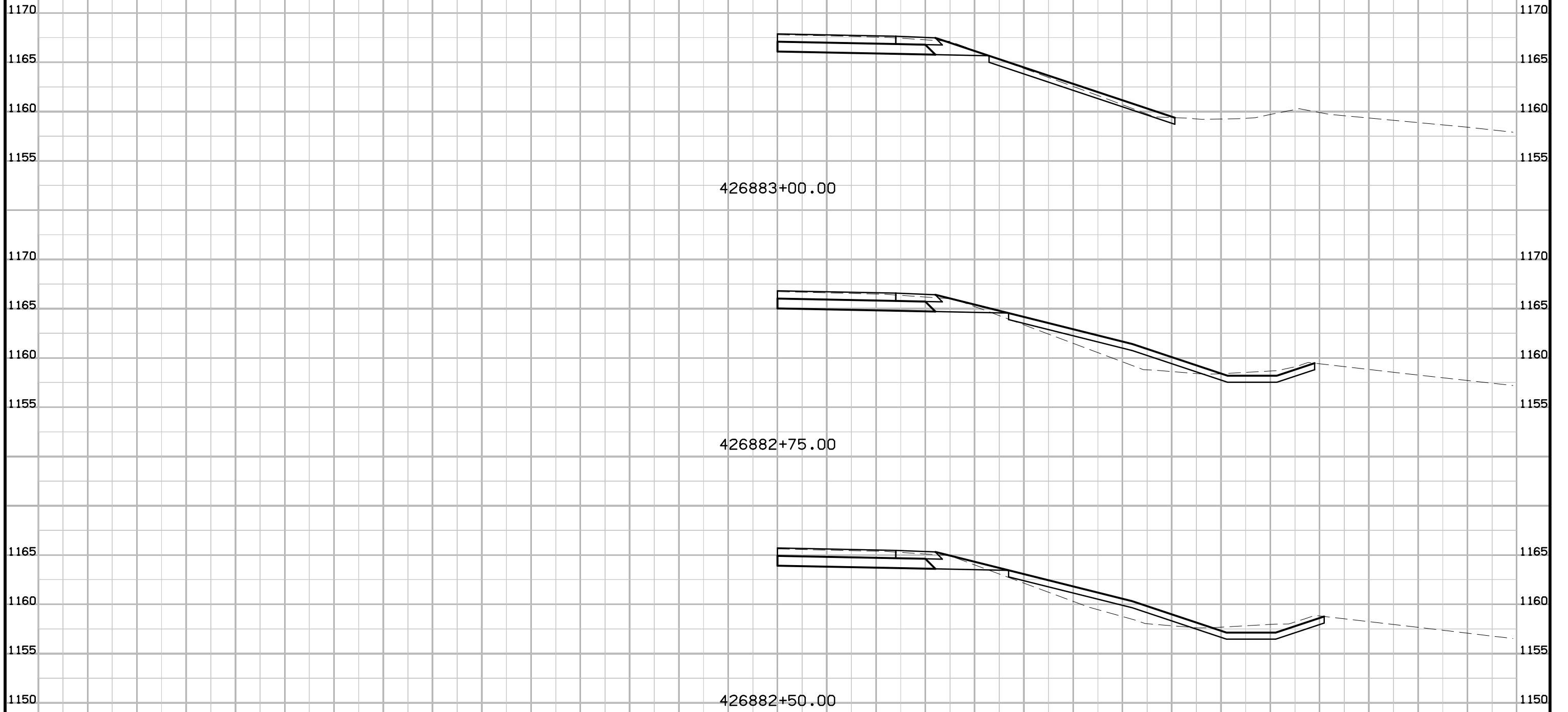

70 65 60 55 50 45 40 35 30 25 20 15 10 5 0 5 10 15 20 25 30 35 40 45 50 55 60 65 70

# Roundabout NB Holy Cross Road Preliminary

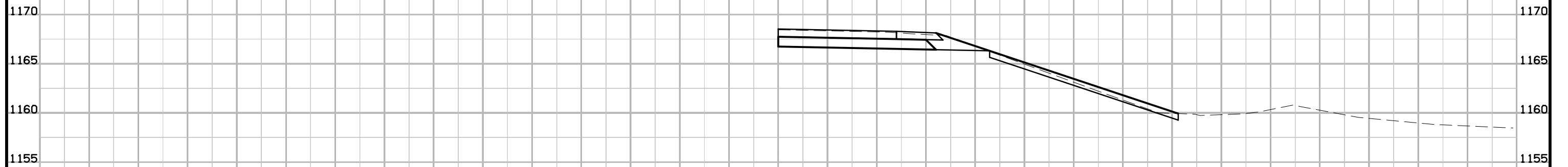

426883+15.31

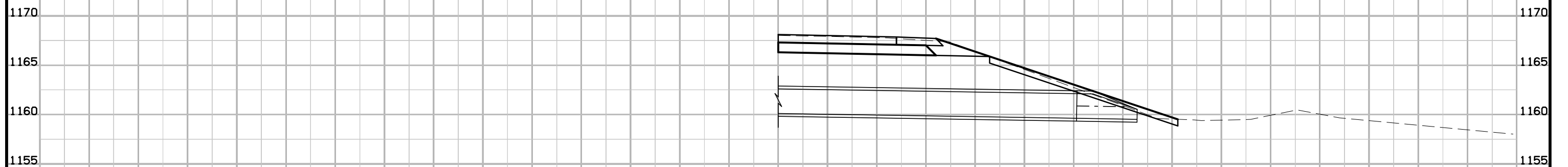

426883+05.31