

142nd Ave

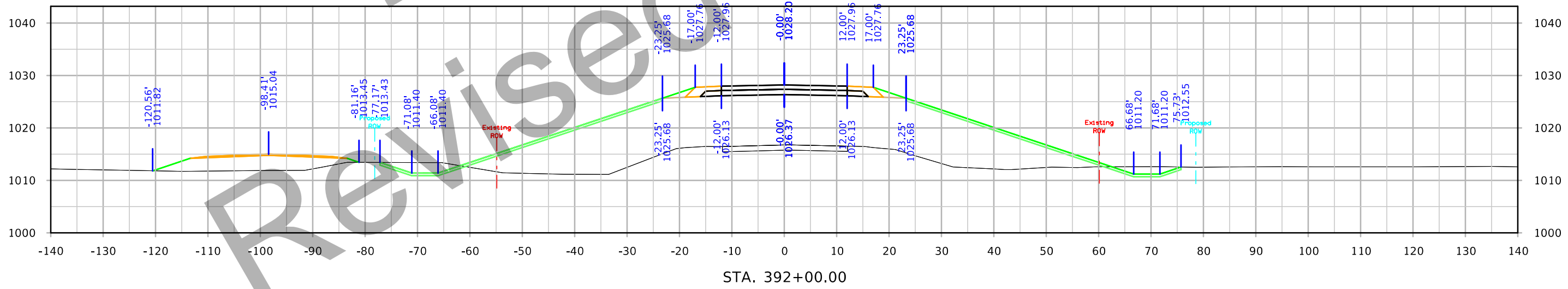

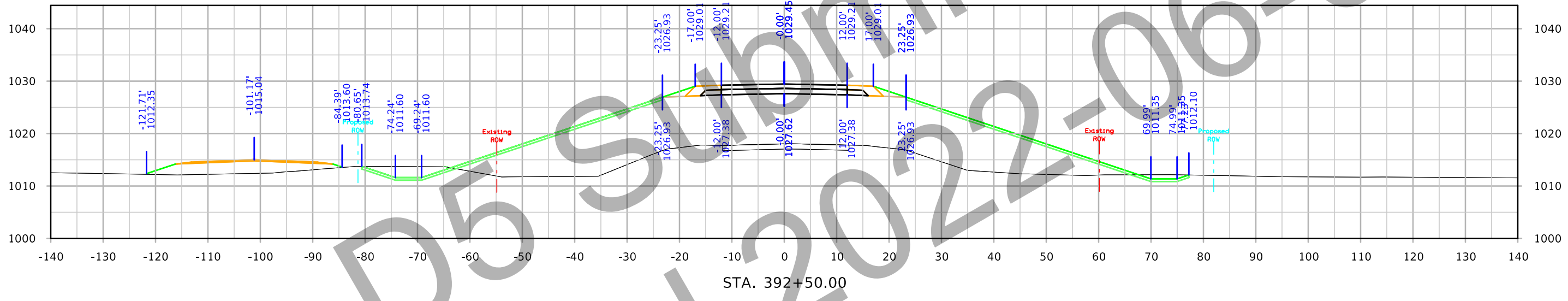

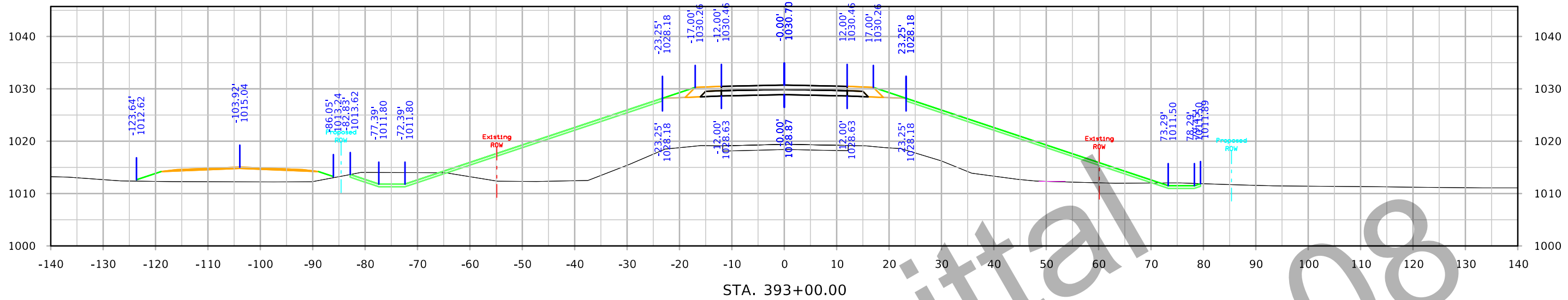

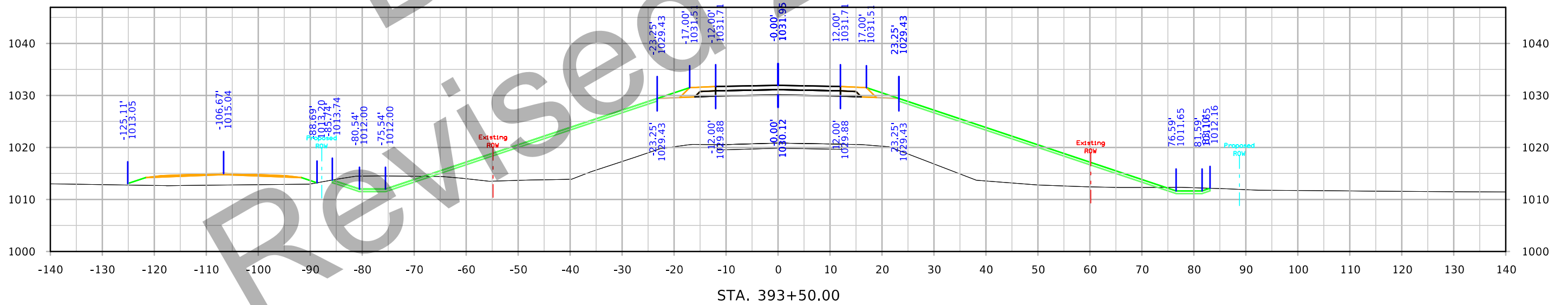
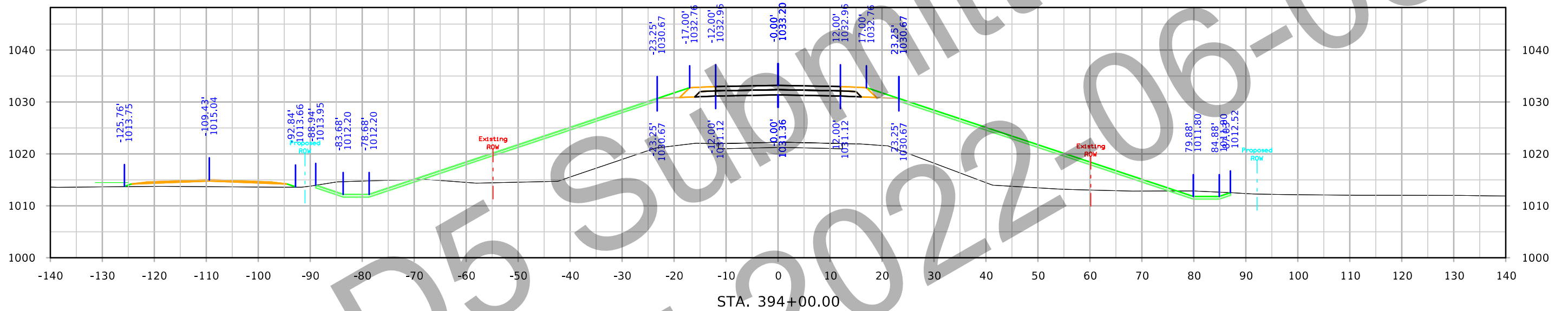
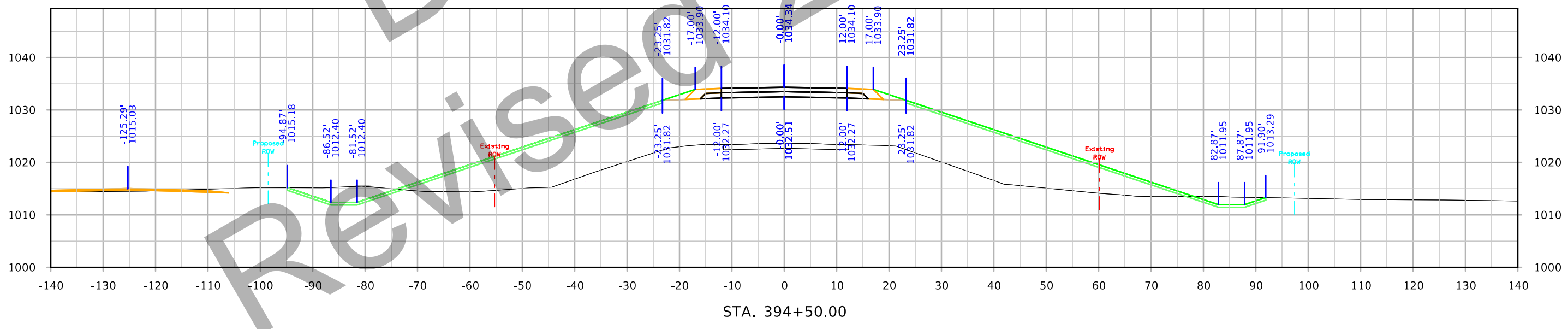
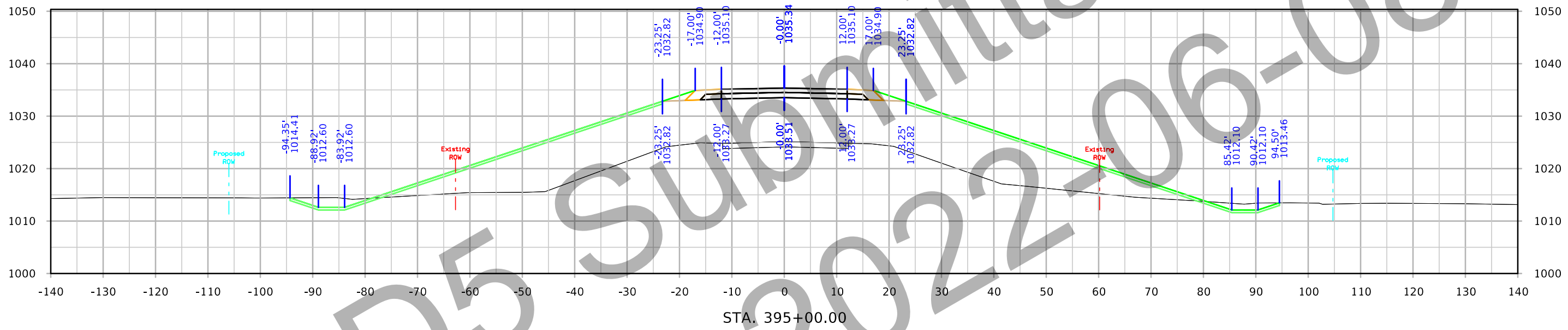
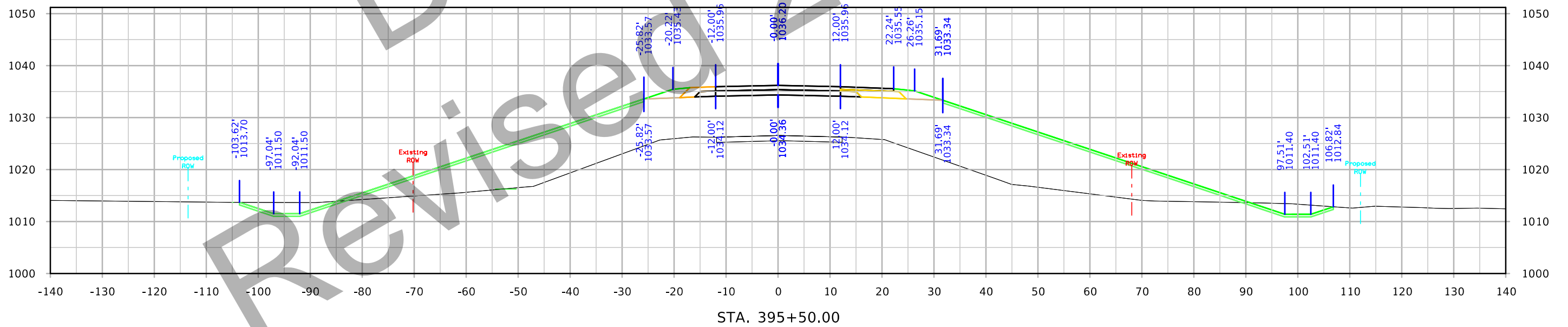
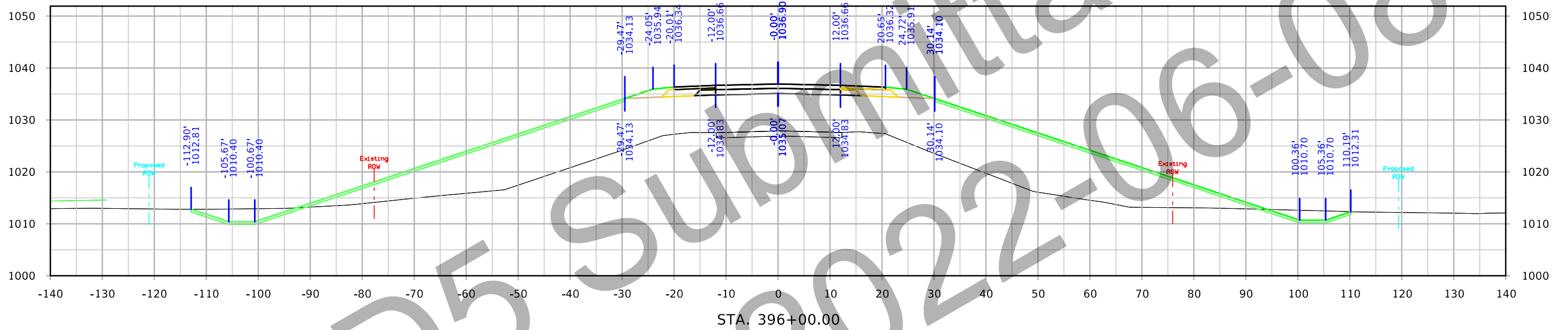

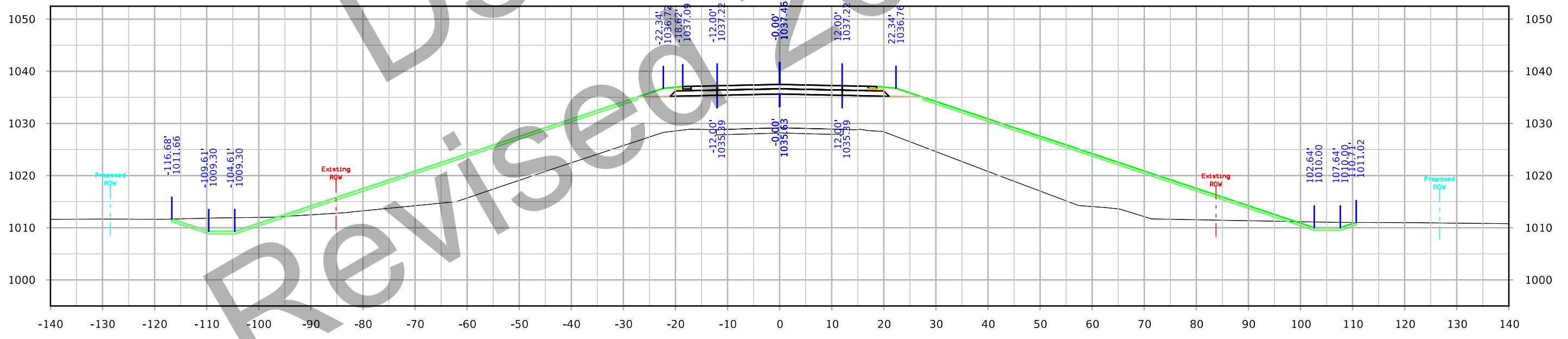
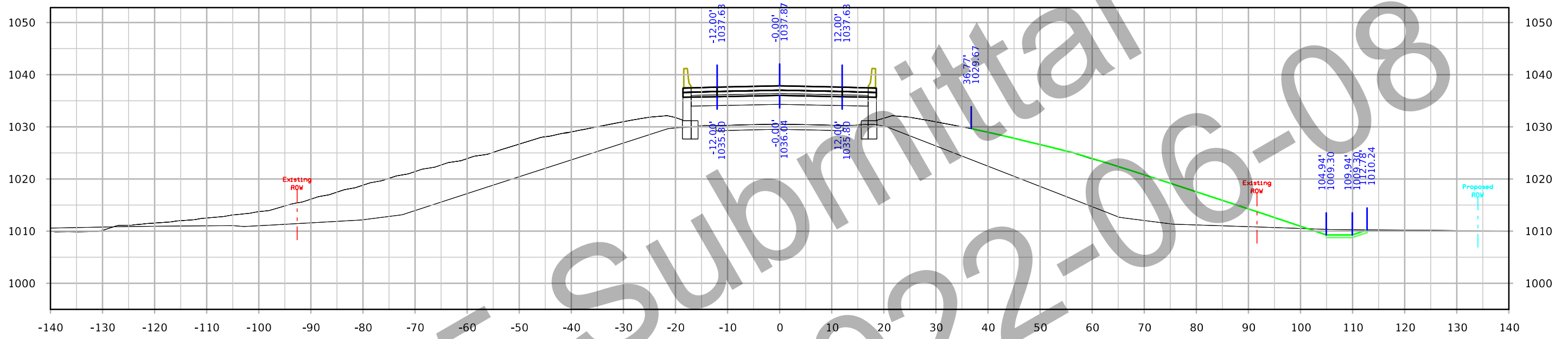

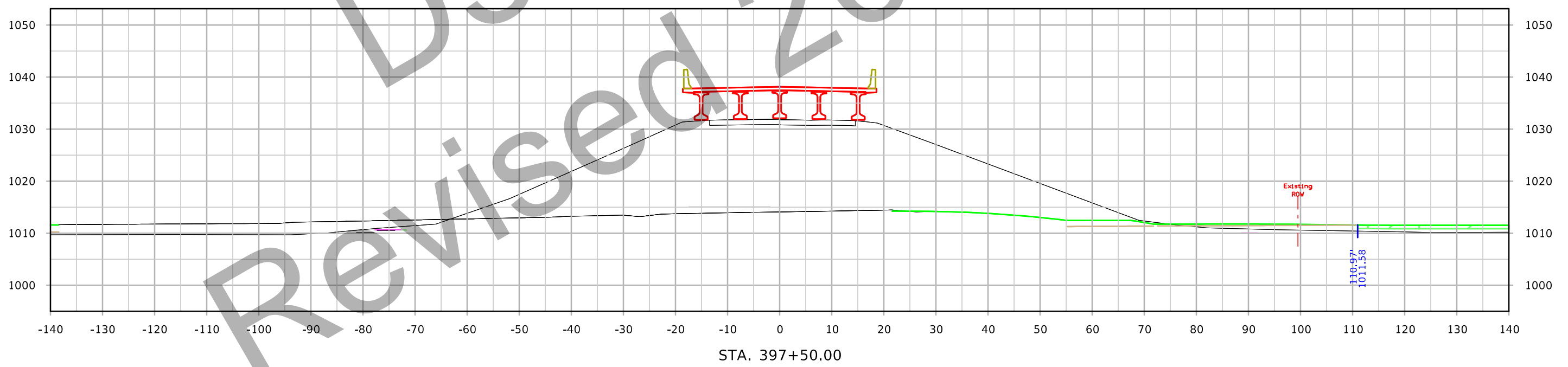
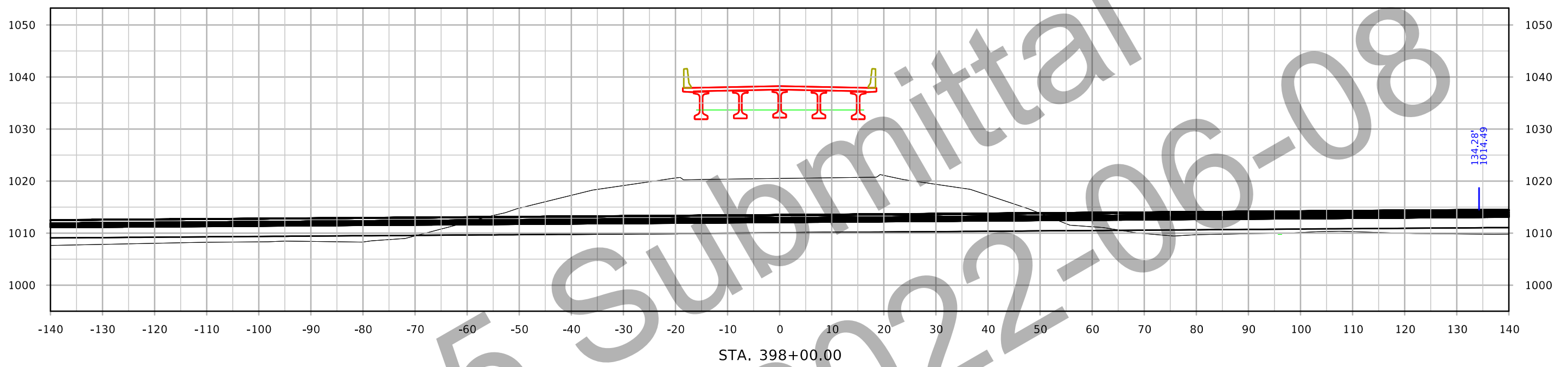

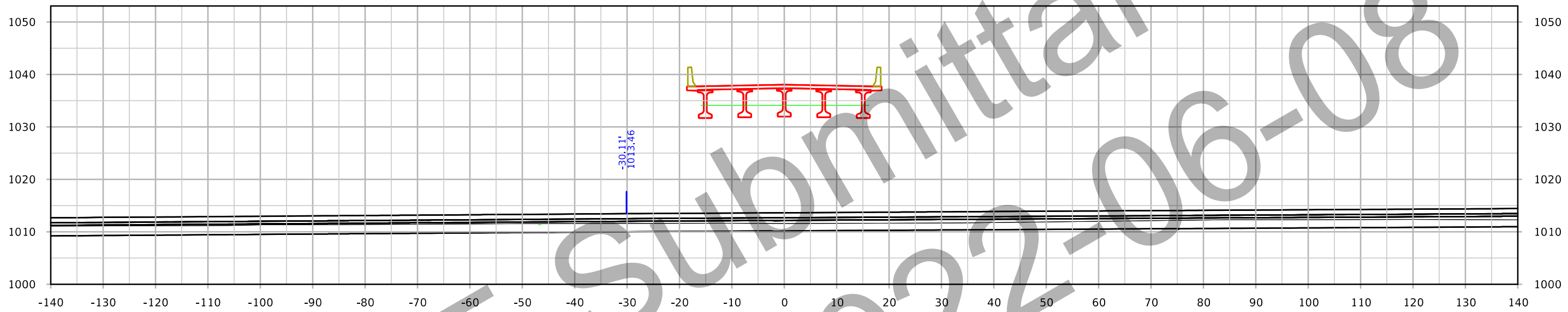

STA. 399+00.00

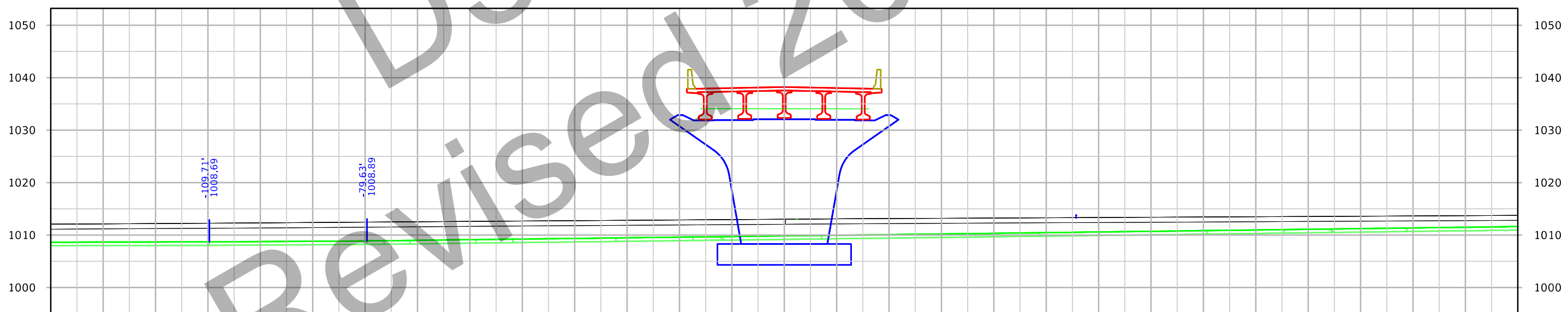

STA. 398+50.00

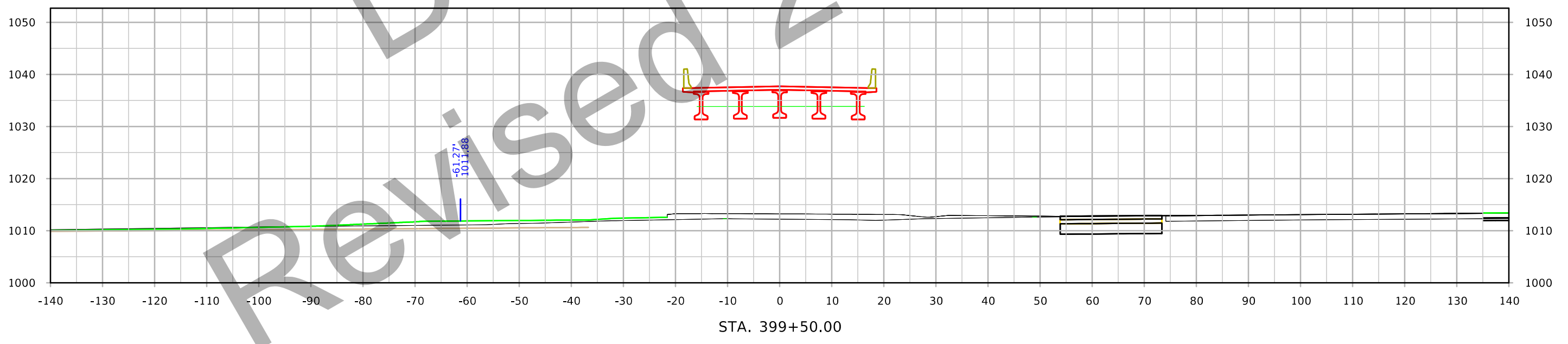
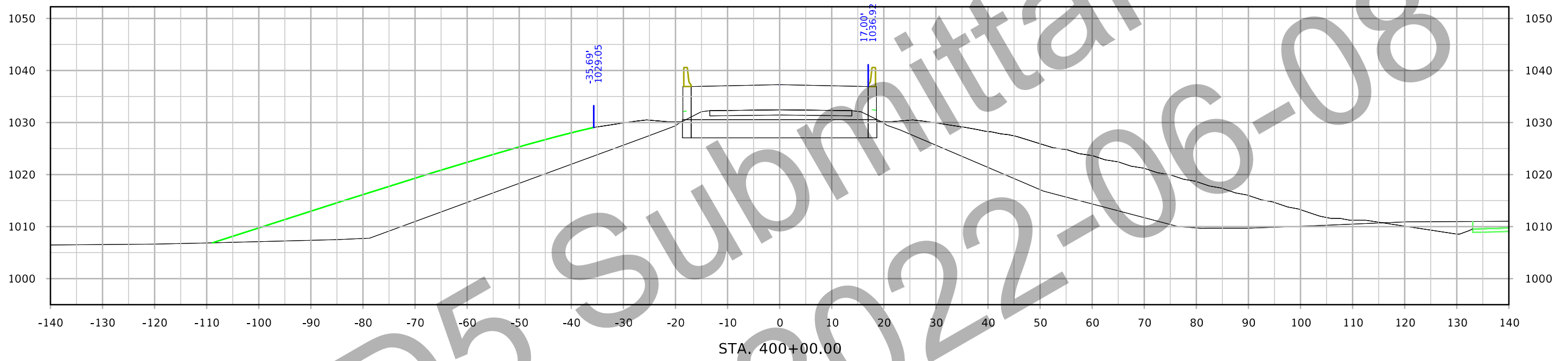

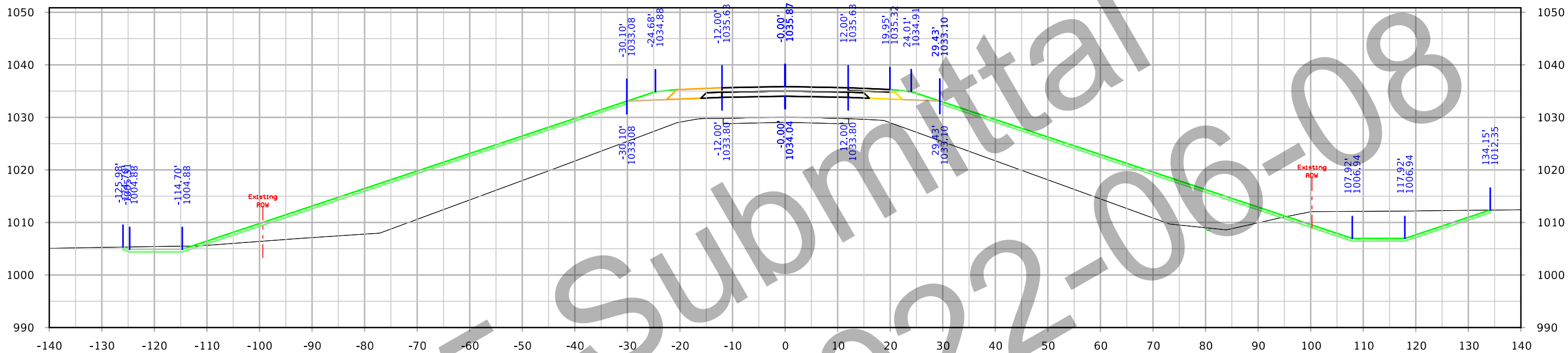

STA. 401+00.00

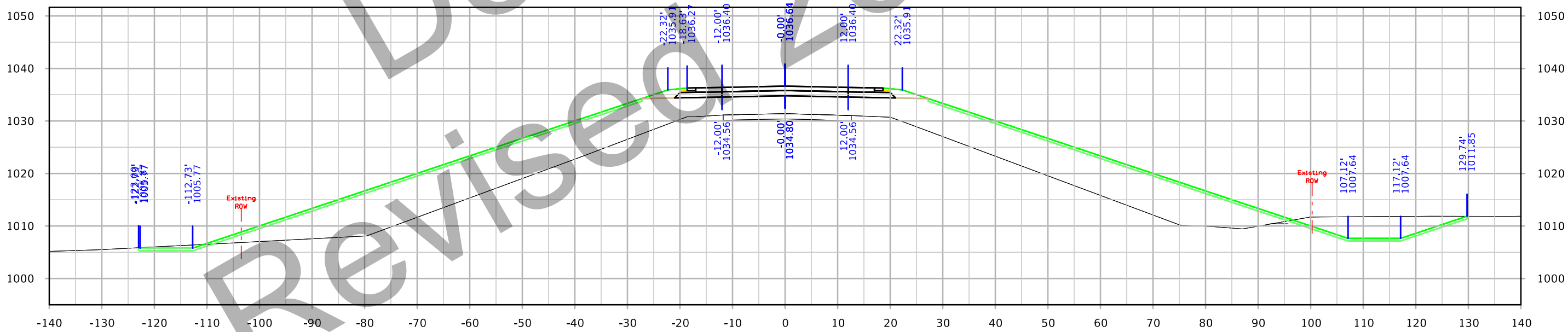

STA. 400+50.00

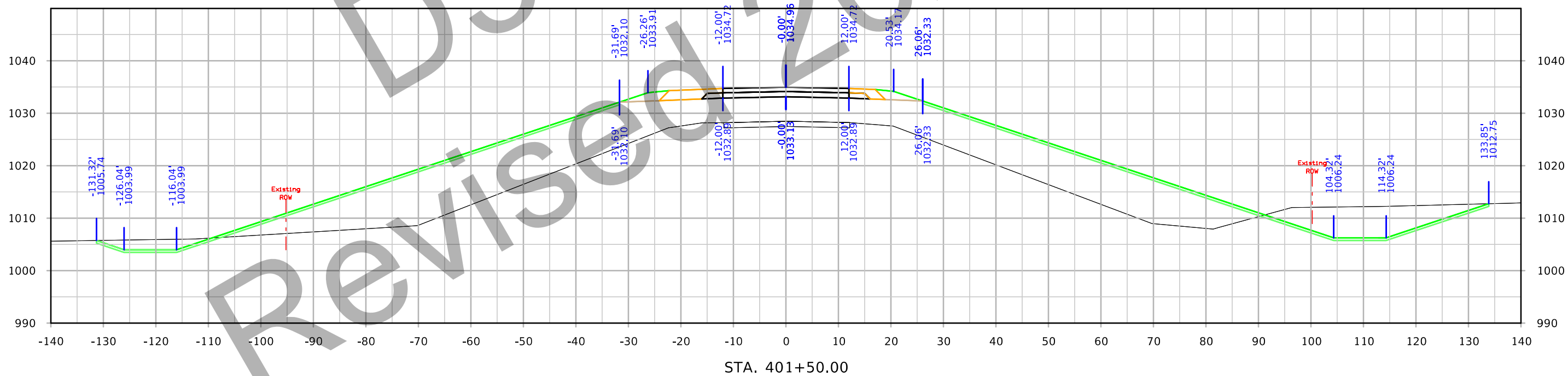
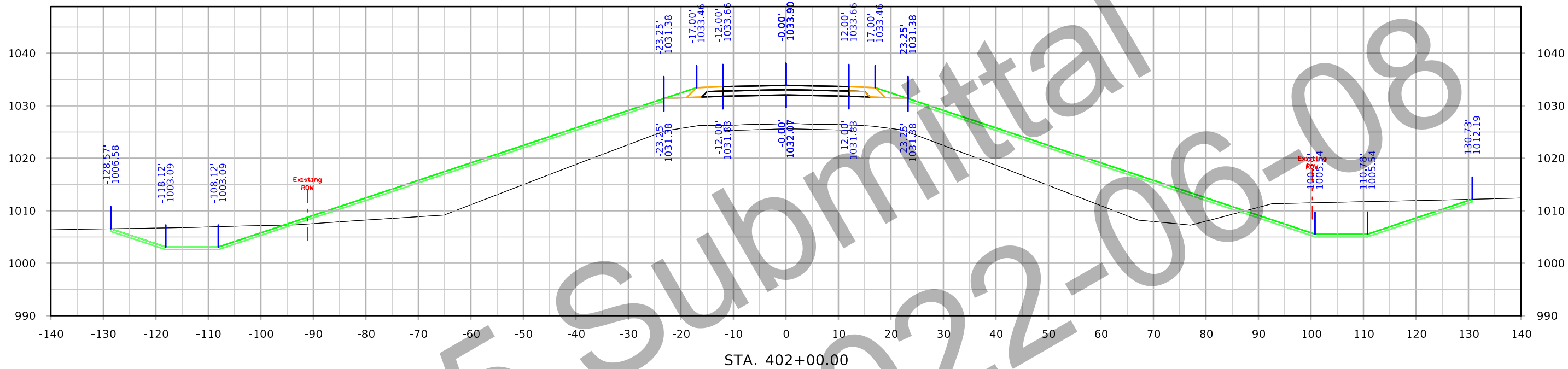

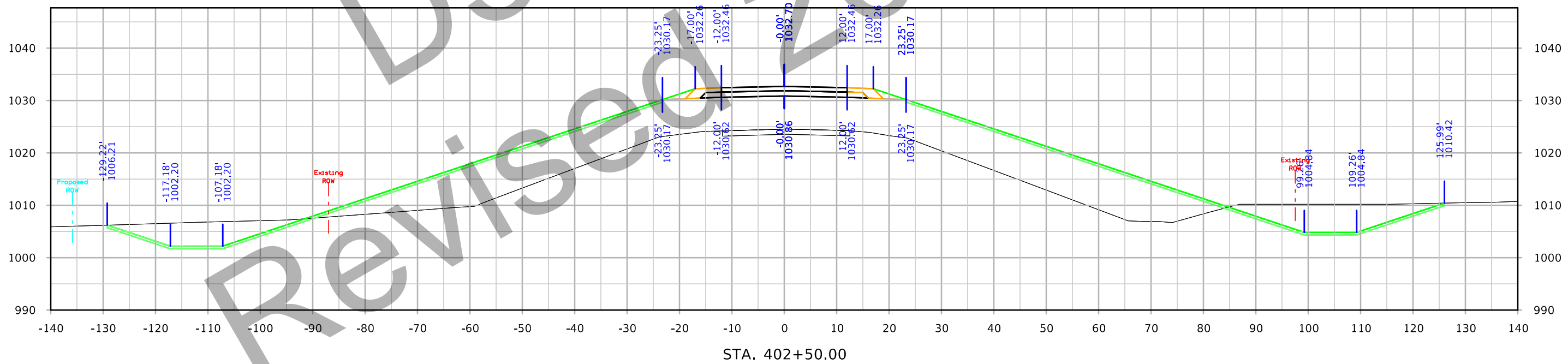
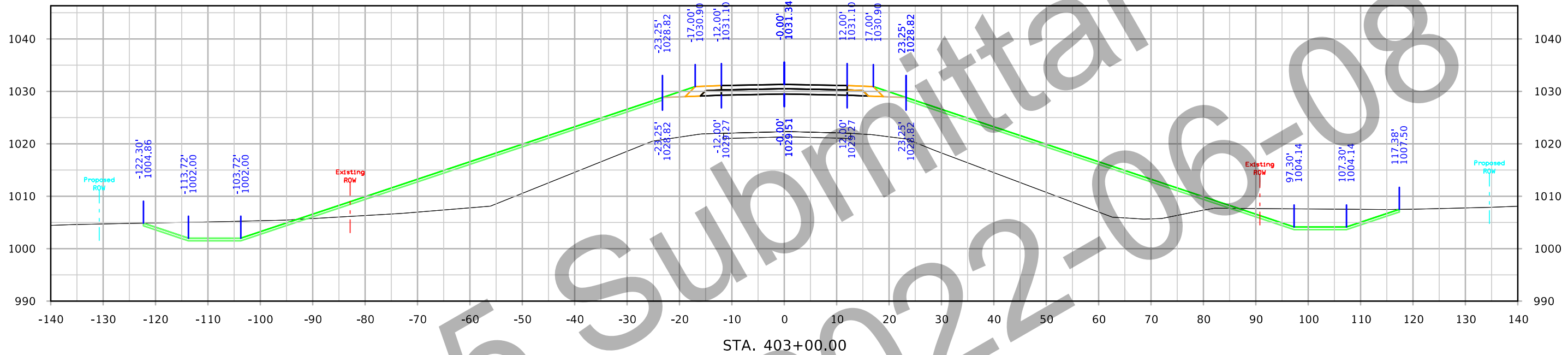

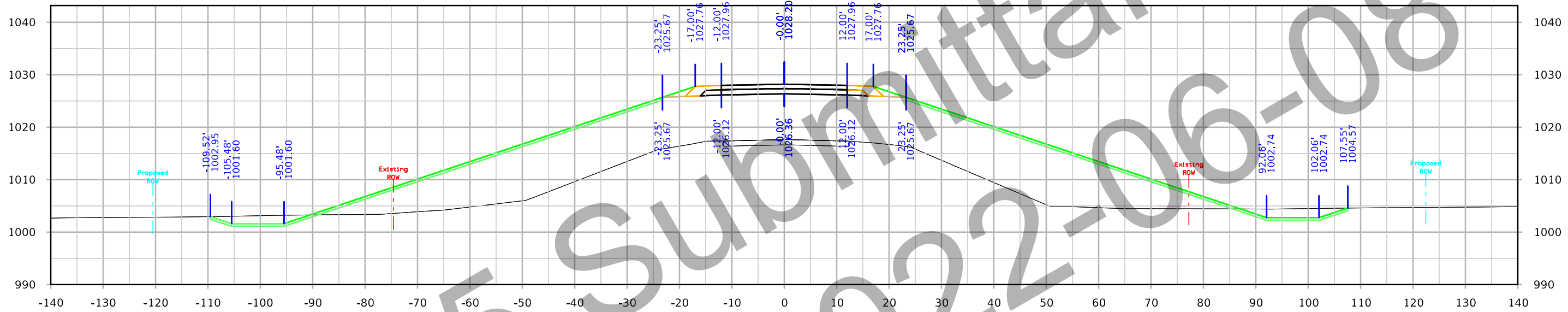

STA. 404+00.00

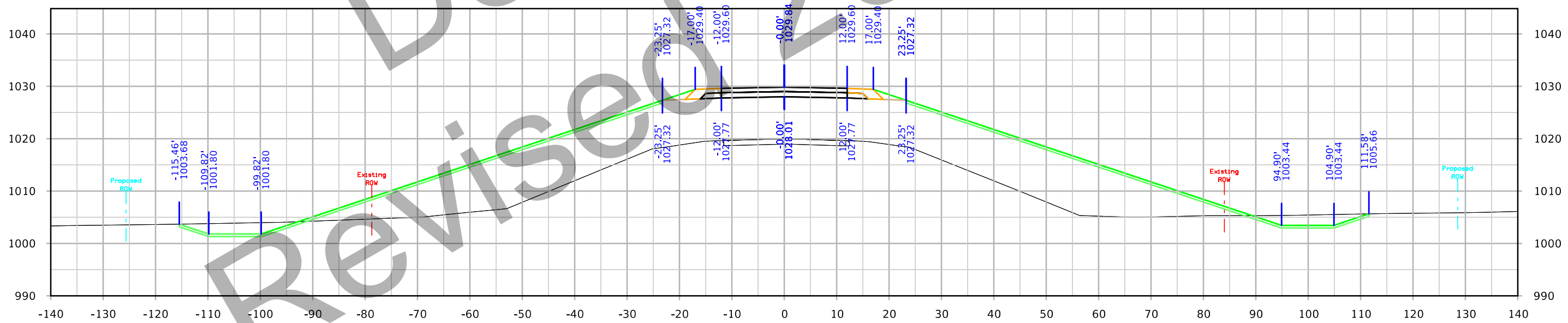

STA. 403+50.00

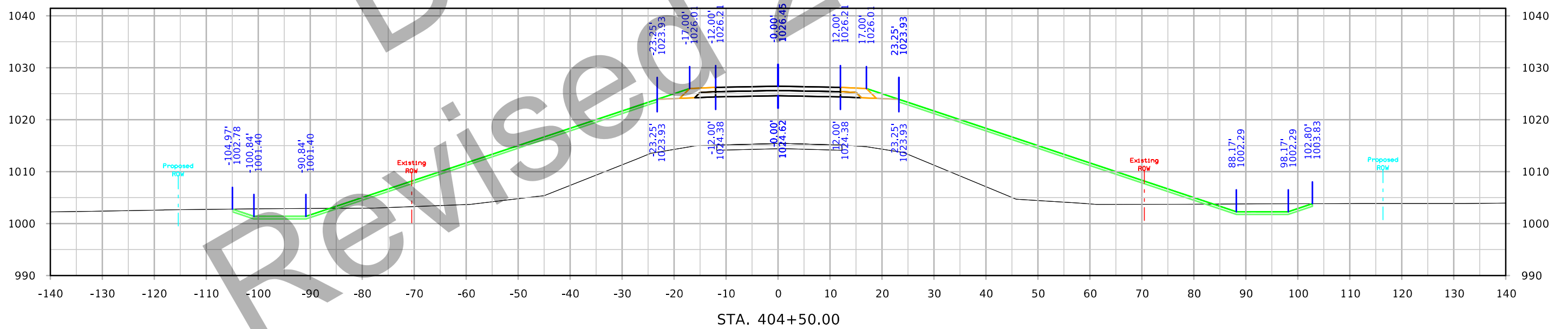
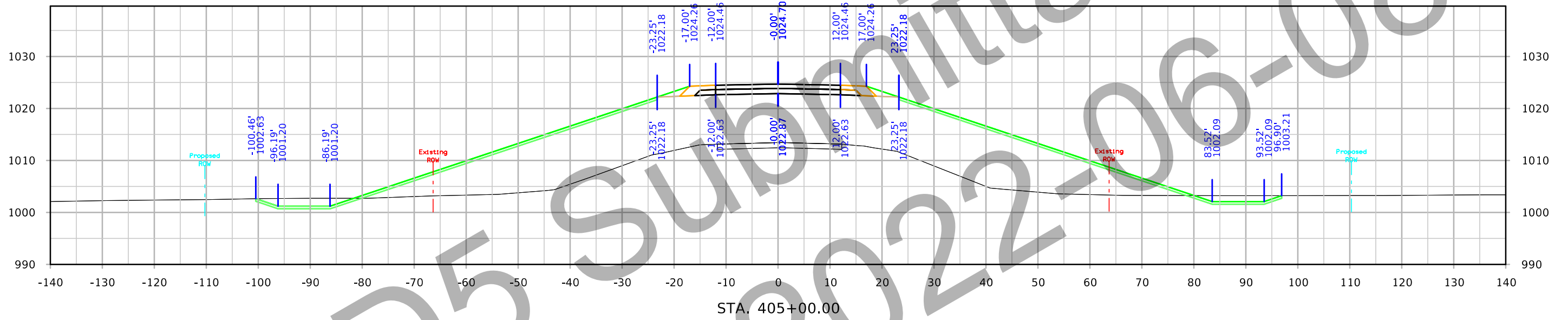

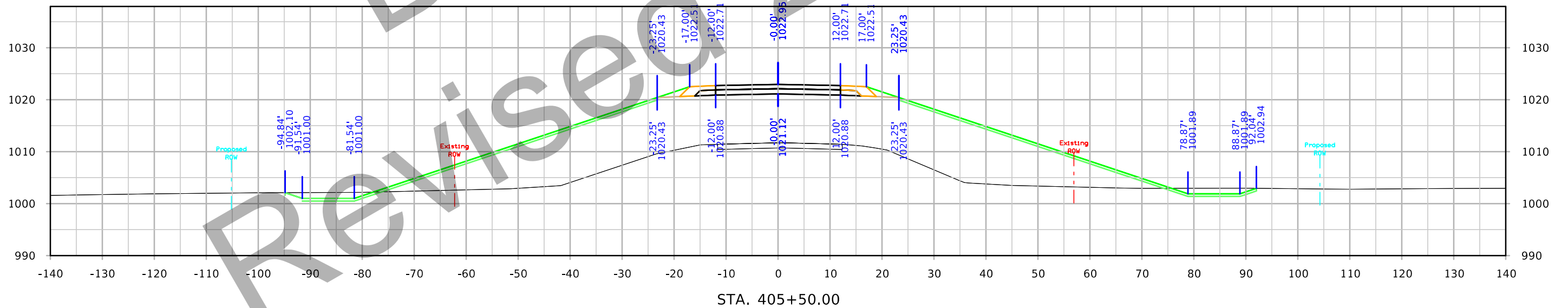
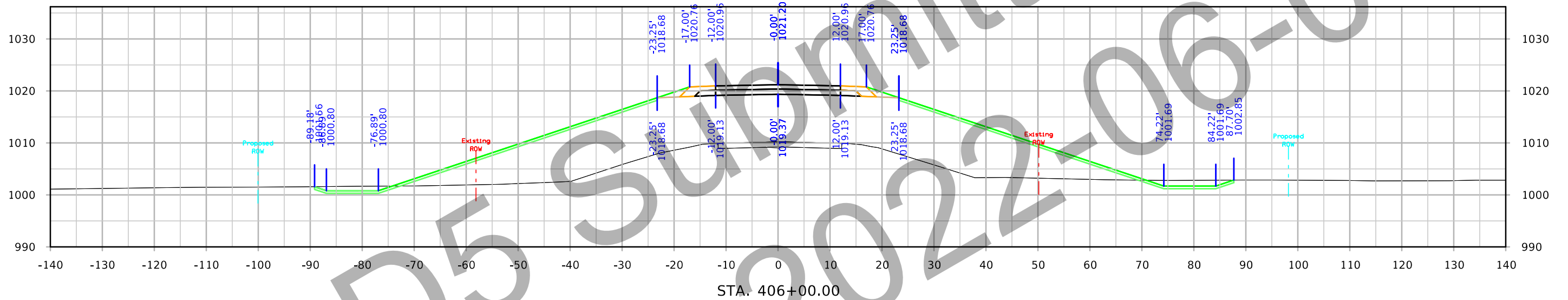

142nd Ave

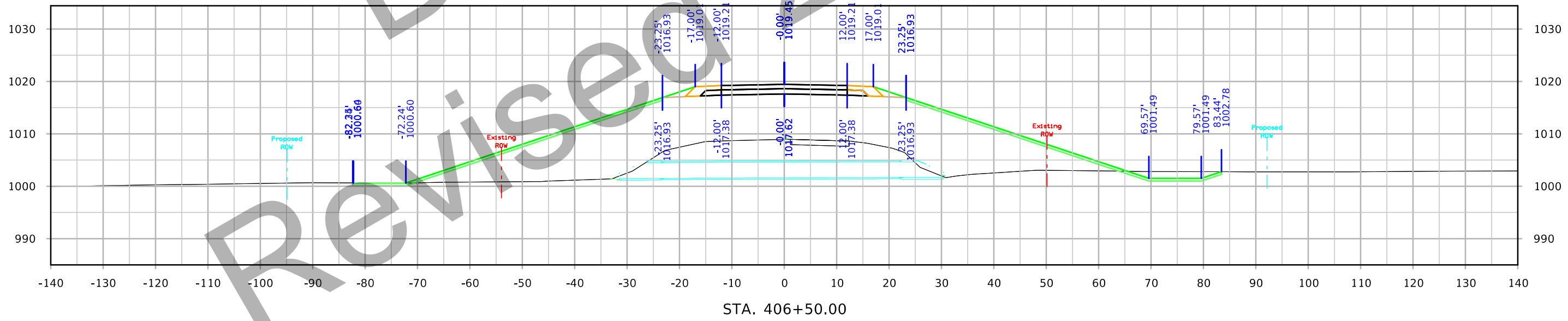
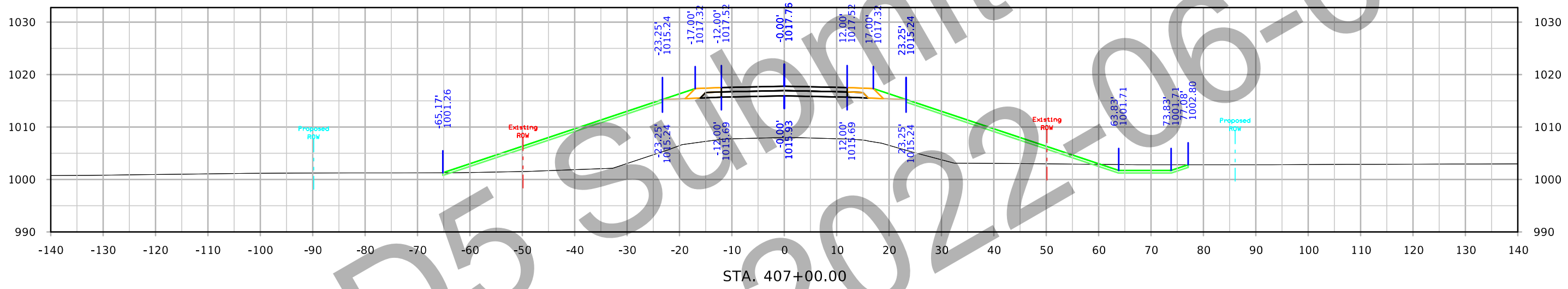
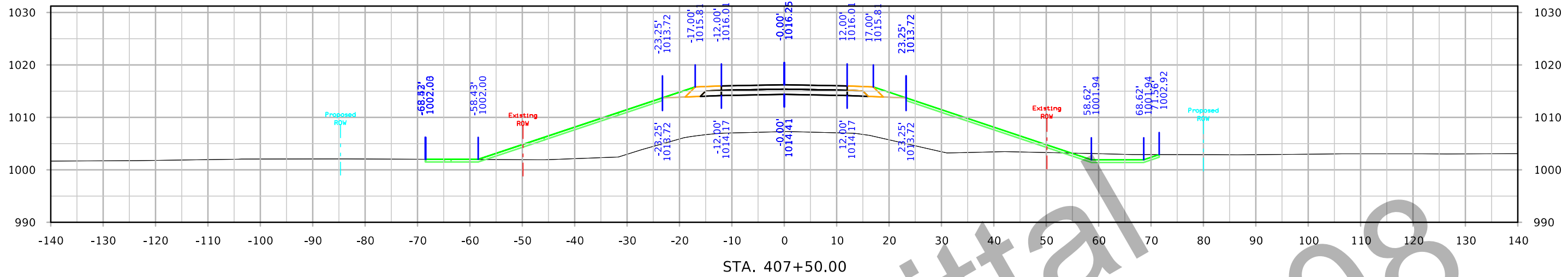

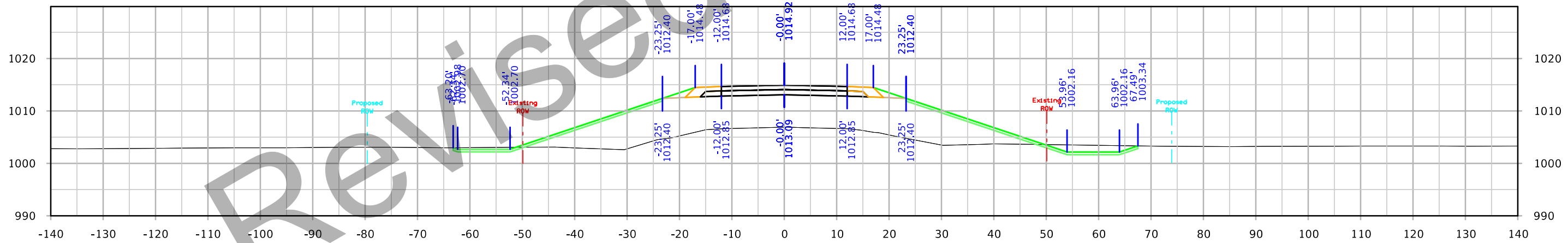
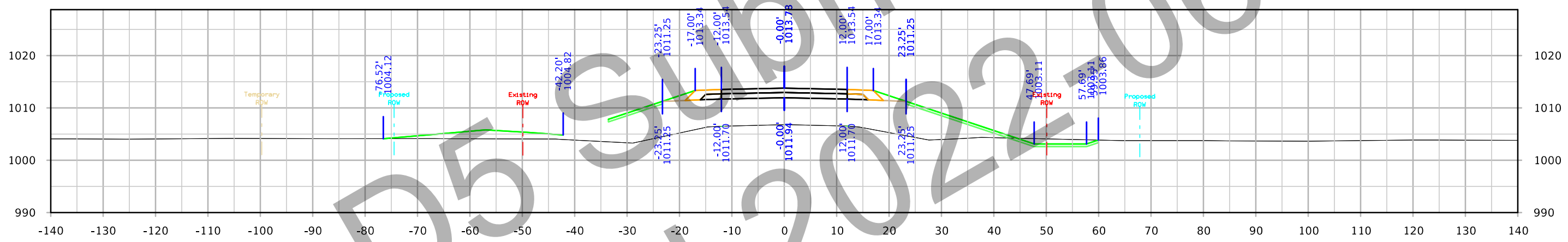
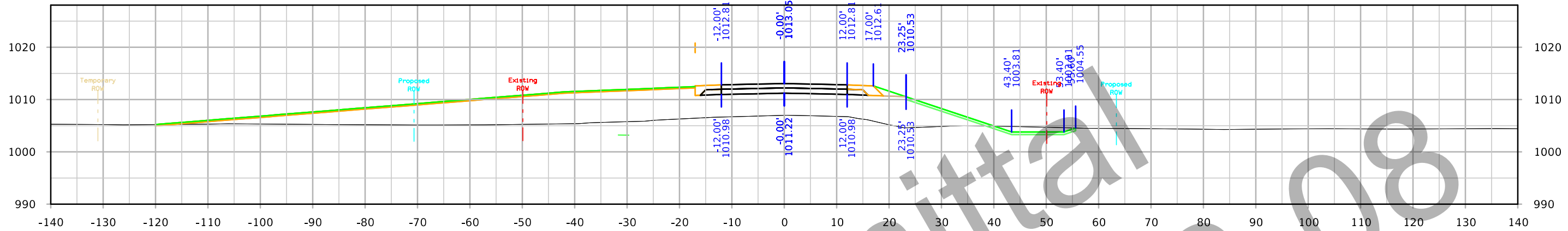

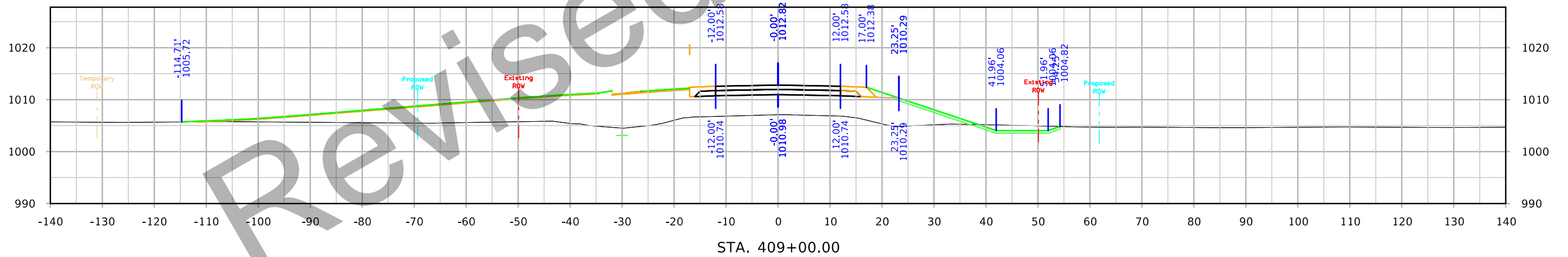
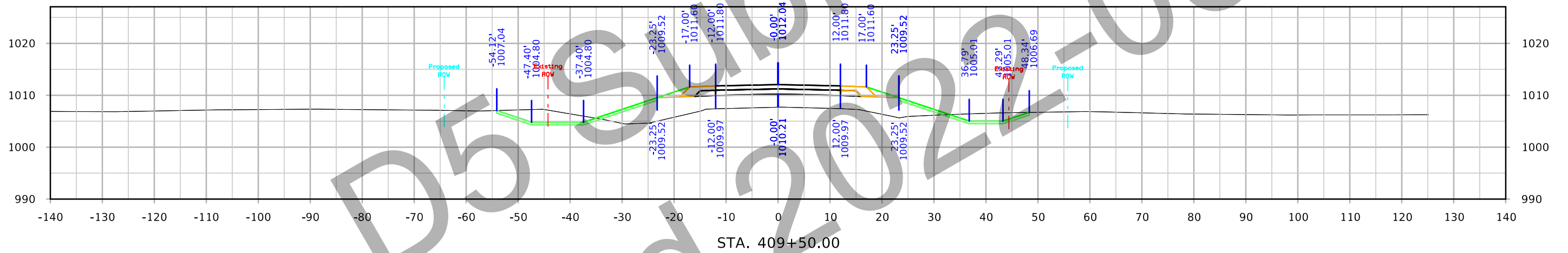
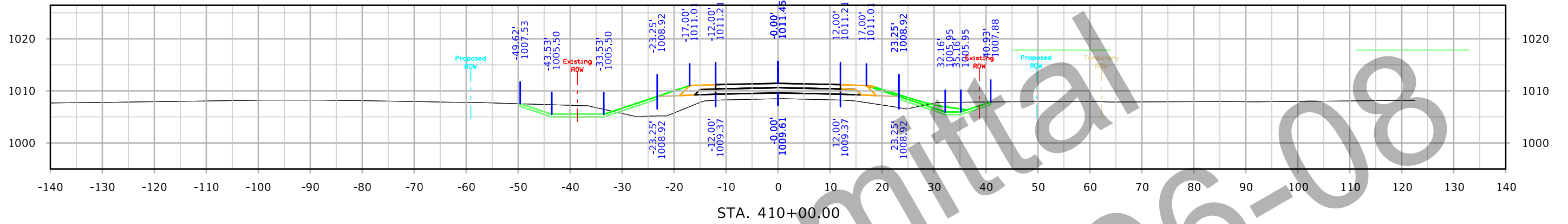

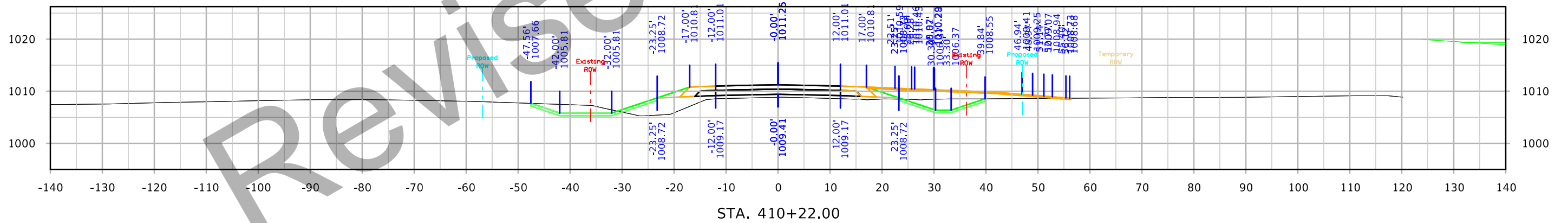
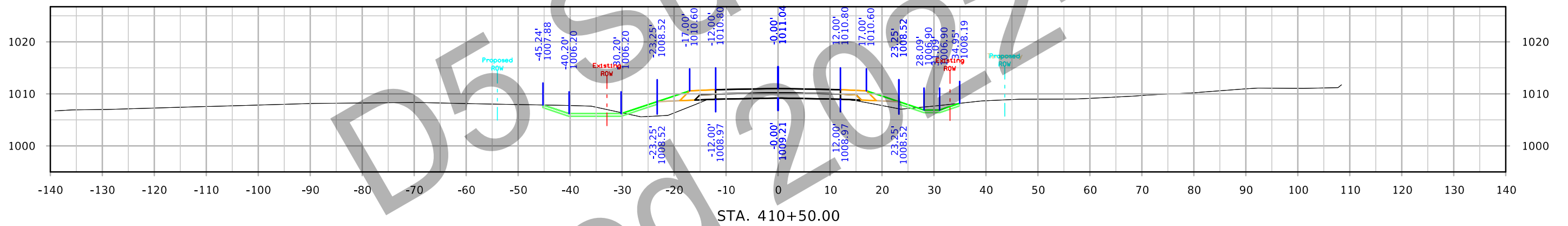
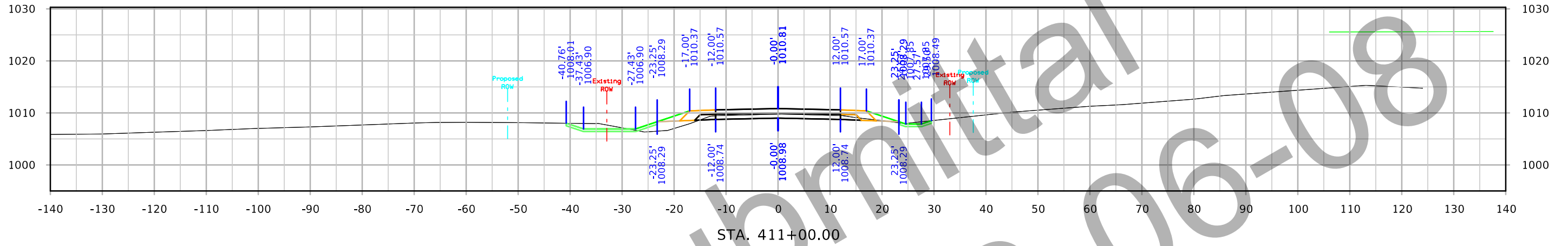

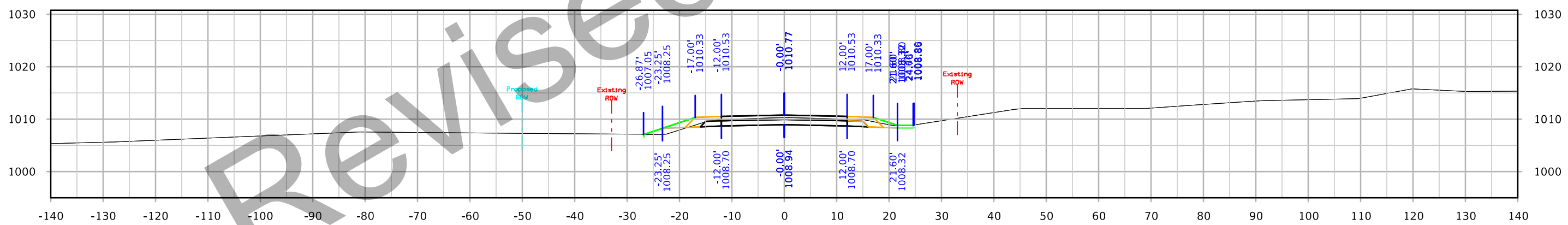
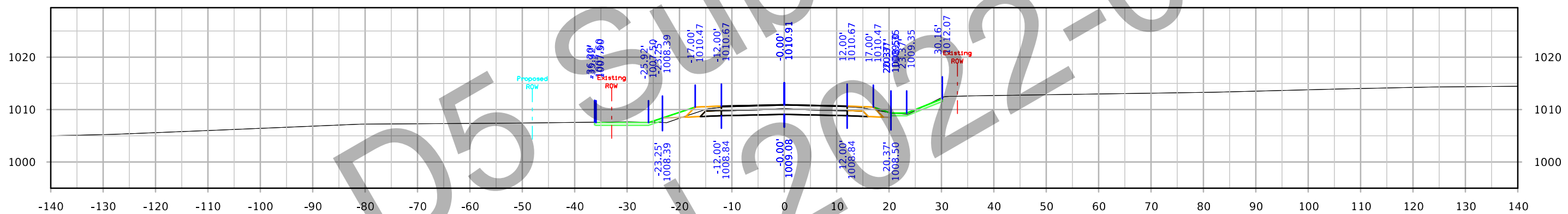
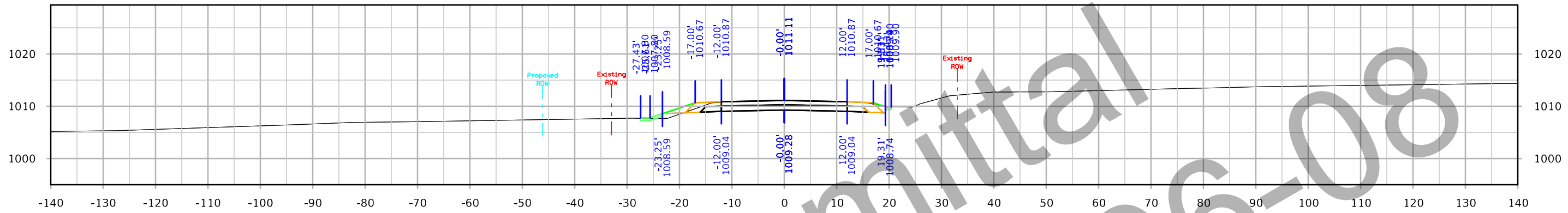

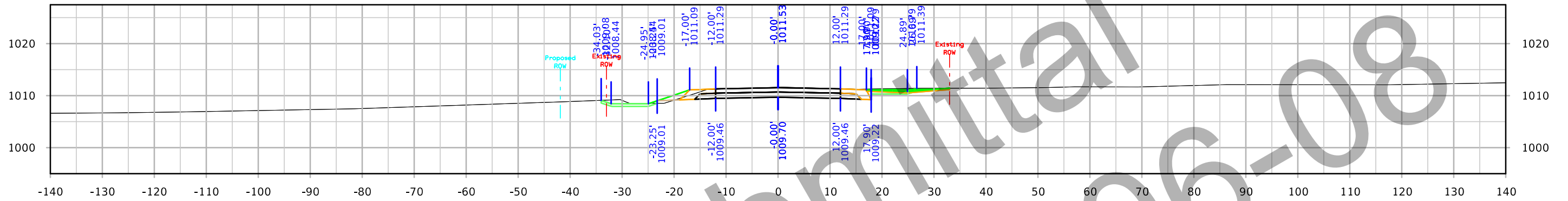

STA. 413+57.00

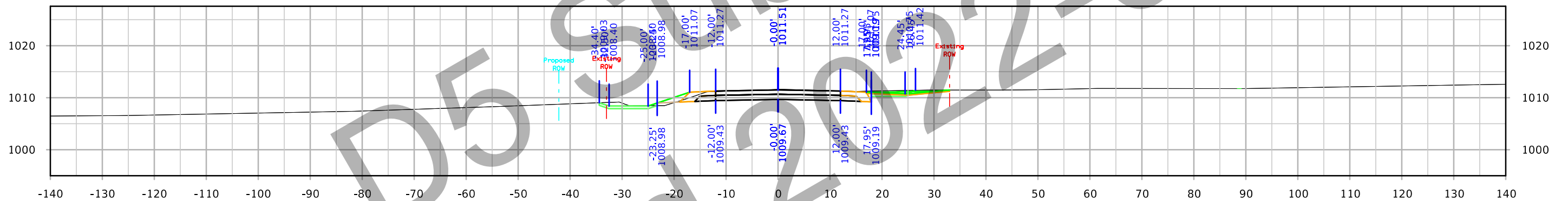

STA. 413+50.00

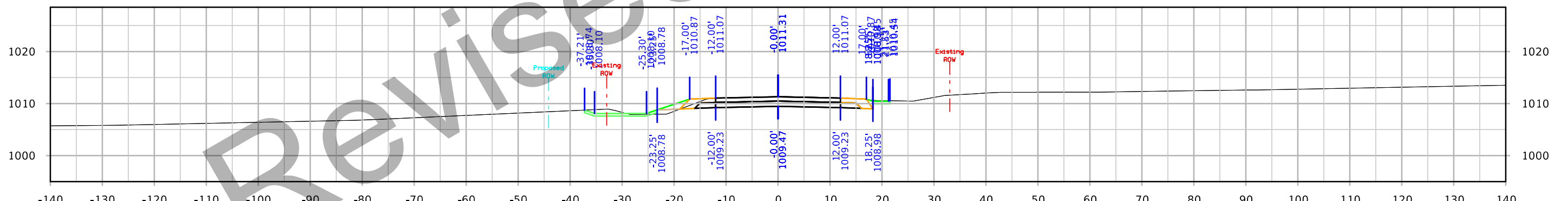

STA. 413+00.00

Revised 2022-06-08
D5 Submittal

