

PLAN

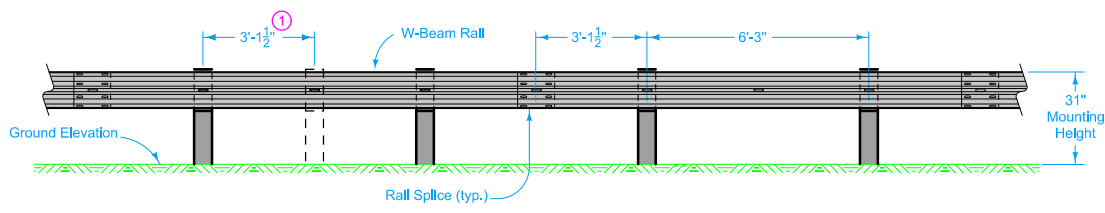

ELEVATION

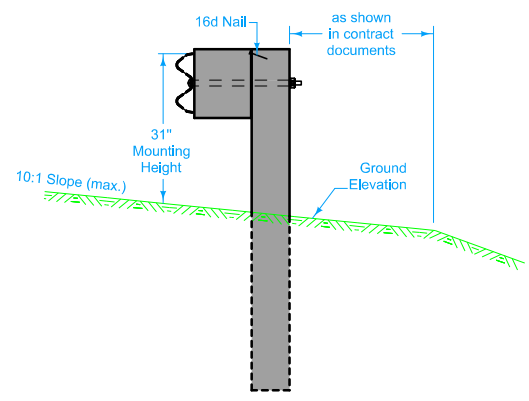

SECTION

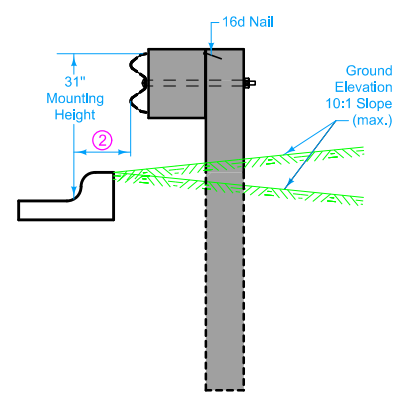

SECTION WITH CURB

W-BEAM INSTALLATION

At Bridge End Drains, cut Scour Protection (Transition Mat and Turf Reinforcement Mat) or remove rock as required to place post(s) such that Bridge End Drains abut post(s).

- ① When specified by the contract documents, install posts at 3'-1 1/2" spacing.
- ② 6" maximum for 6" Standard or 6" Sloped curbs and for non-standard curbs.
- ③ Wood or composite only. Steel blockouts will not be allowed.

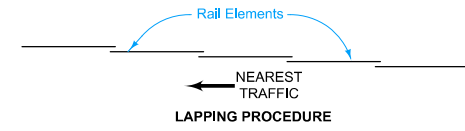

Possible Contract Item:
Steel Beam Guardrail

	REVISION
	4 10-18-16
STANDARD ROAD PLAN	BA-200
SHEET 1 of 4	
REVISIONS: Added holes on steel posts and corresponding blockouts.	
APPROVED BY DESIGN METHODS ENGINEER	
STEEL BEAM GUARDRAIL COMPONENTS	

STEEL POST AND BLOCKOUT DETAILS

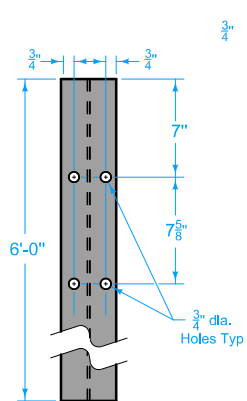

6'-0" STEEL POST
W6x9 or W6x8.5

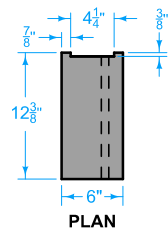

PLAN

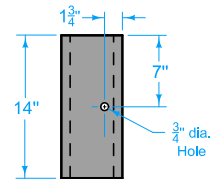

ELEVATION

W-BEAM BLOCKOUT ③

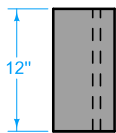

PLAN

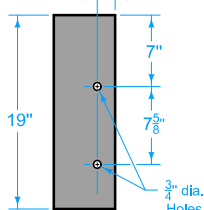

ELEVATION

THRIE-BEAM BLOCKOUT ③

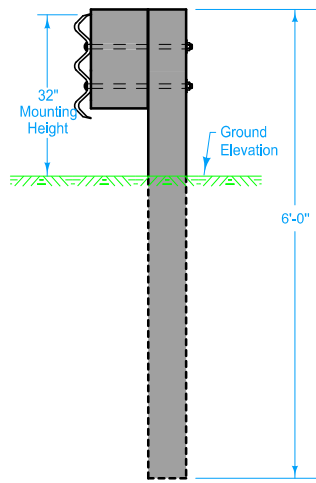

THRIE-BEAM INSTALLATION

③ Wood or composite only. Steel blockouts will not be allowed.

WOOD POST AND BLOCKOUT DETAILS

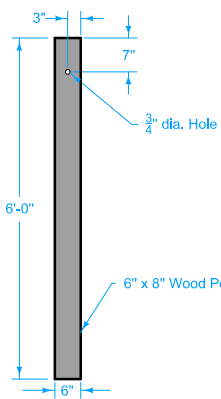

W-BEAM

POSTS

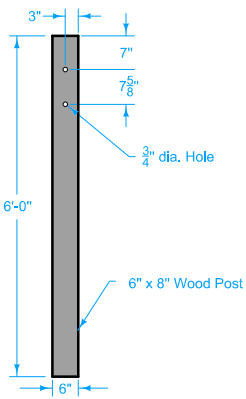

THRIE-BEAM

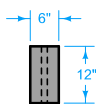

PLAN

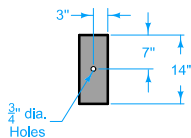

ELEVATION

W-BEAM BLOCKOUT ③

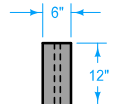

PLAN

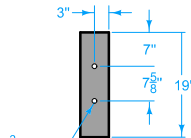

ELEVATION

THRIE-BEAM BLOCKOUT ③

BOLT DETAILS

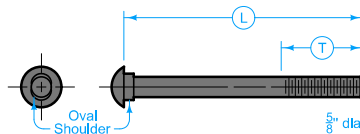

BOLT

APPLICATION	T	L
Splice Bolt	1 1/16"	1 1/4"
Bolt for Steel Post with 8" Blockout	2 1/2"	10"
Bolt for Steel Post with 12" Blockout	2 1/2"	14"
Bolt for Wood Post with 8" Blockout	2 1/2"	18"
Bolt for Wood Post with 12" Blockout	2 1/2"	22"

T = Min. Thread Length L = Bolt Length

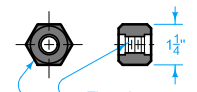

NUT

HARDWARE

<p>STANDARD ROAD PLAN</p>	REVISION 4 10-18-16
	BA-200 SHEET 2 of 4
	REVISIONS: Added holes on steel posts and corresponding blockouts.

Brian Smith
APPROVED BY DESIGN METHODS ENGINEER

STEEL BEAM GUARDRAIL COMPONENTS

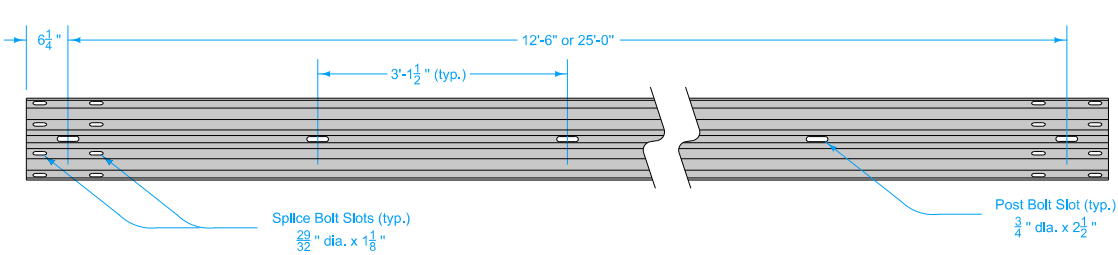

ELEVATION

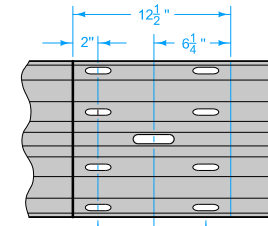

RAIL SPLICE

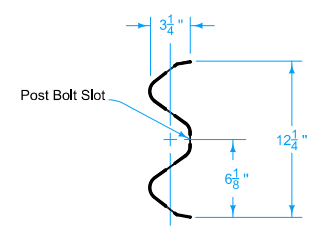

SECTION

W-BEAM RAIL

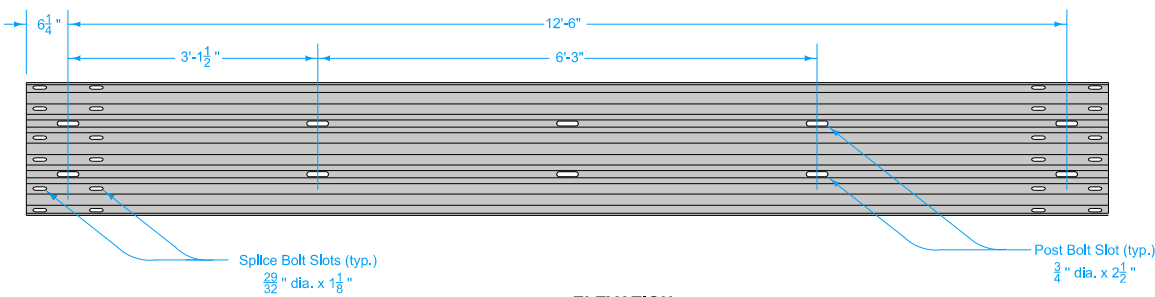

ELEVATION

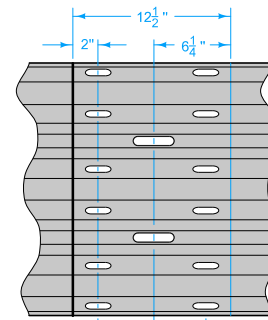

RAIL SPLICE

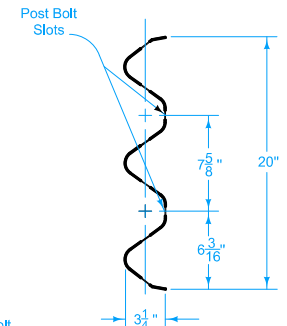

SECTION

THREE-BEAM RAIL

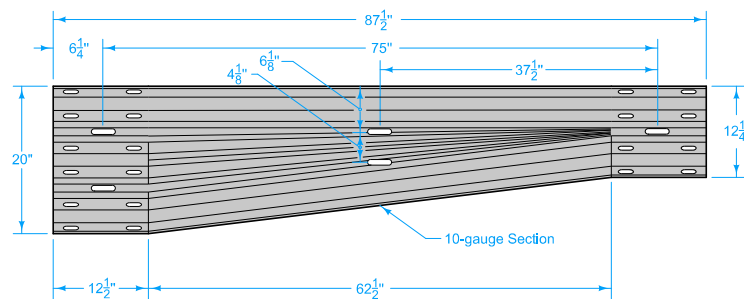

ASYMMETRICAL TRANSITION SECTION

<p>STANDARD ROAD PLAN</p> <p>REVISIONS: Added holes on steel posts and corresponding blockouts.</p> <p><i>Brian Smith</i> APPROVED BY DESIGN METHODS ENGINEER</p> <p>STEEL BEAM GUARDRAIL COMPONENTS</p>	<p>REVISION</p> <p>4 10-18-16</p>
	<p>BA-200</p> <p>SHEET 3 of 4</p>

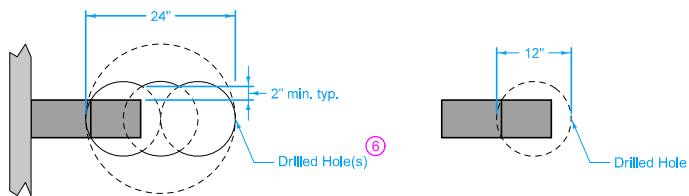
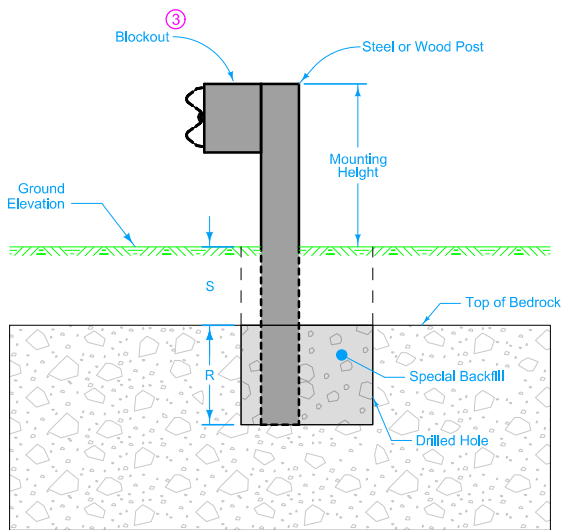

PLAN - CASE A

PLAN - CASE B

Post Embedment (4)		
Case	Depth to Bedrock	Minimum Depth to Drill into Bedrock
A	S = 0" to 16"	R = 24"
B	S = 16" to 52"	R = Post Length - Mounting Height - S

POST INSTALLED IN BEDROCK

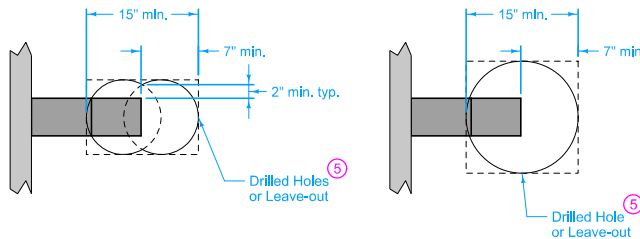
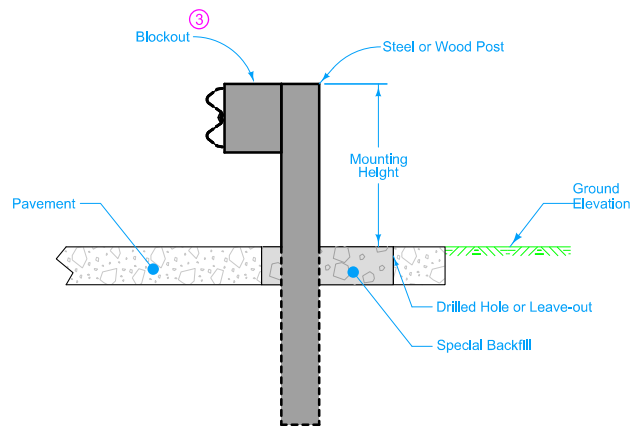

PLAN - PAVEMENT THICKNESS <= 8"
Either approach is acceptable.

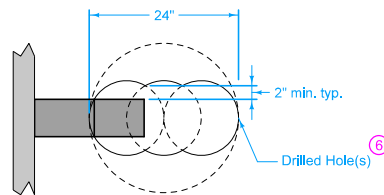

PLAN - PAVEMENT THICKNESS > 8"

POST INSTALLED IN PAVEMENT

Installation information applies to both wood and steel posts.

- (3) Wood or composite only. Steel blockouts will not be allowed.
- (4) Post extends to bottom of hole in all cases. Trim top of post as required and treat with preservative according to Section 4161 of the Standard Specifications.
- (5) Use a 12 inch bit with two drills or a 15 inch bit with one drill. If placing post before paving, provide required leave-out area. If placing post after paving, drill or cut required area. Leave-out may be round or square.
- (6) Use a 12 inch bit with three drills or a 24 inch bit with one drill.

	REVISION	4	10-18-16
	STANDARD ROAD PLAN	BA-200	
			SHEET 4 of 4

REVISIONS: Added holes on steel posts and corresponding blockouts.

Brian Smith
APPROVED BY DESIGN METHODS ENGINEER

STEEL BEAM GUARDRAIL COMPONENTS