

JOHNSON CO. RCB CULVERT REPLACEMENT - TWIN BOX
BRF-001-5(108)--38-52

LETTING DATE
10/15/2019



Highway Division

PLANS OF PROPOSED IMPROVEMENT ON THE

PRIMARY ROAD SYSTEM
JOHNSON COUNTY
RCB CULVERT REPLACEMENT - TWIN BOX

Stream 2.1 mi S of Co Rd F52

SCALES: As Noted

Refer to the Proposal Form for list of applicable specifications.

Value Engineering Saves. Refer to Article 1105.14 of the Specifications.



REVISIONS

TOTAL

16

PROJECT IDENTIFICATION NUMBER

15-52-001-010

PROJECT NUMBER

BRF-001-5(108)--38-52

R.O.W. PROJECT NUMBER

NHSN-001-5(109)--2R-52

INDEX OF SHEETS

No.	DESCRIPTION
A Sheets	Title Sheets
A.1	Title Sheet & Location Map
B Sheets	Typical Cross Sections and Details
B.1 - 4	Typical Cross Sections and Details
D Sheets	Mainline Plan and Profile Sheets
* D.1	Plan & Profile Legend & Symbol Information Sheet
* D.2 - 3	IA 1
G Sheets	Survey Sheets
G.1 - 3	Reference Ties and Bench Marks
J Sheets	Traffic Control and Staging Sheets
* J.1	Traffic Control Plan
W Sheets	Mainline Cross Sections
W.1 - 4	IA 1
	* Color Plan Sheets

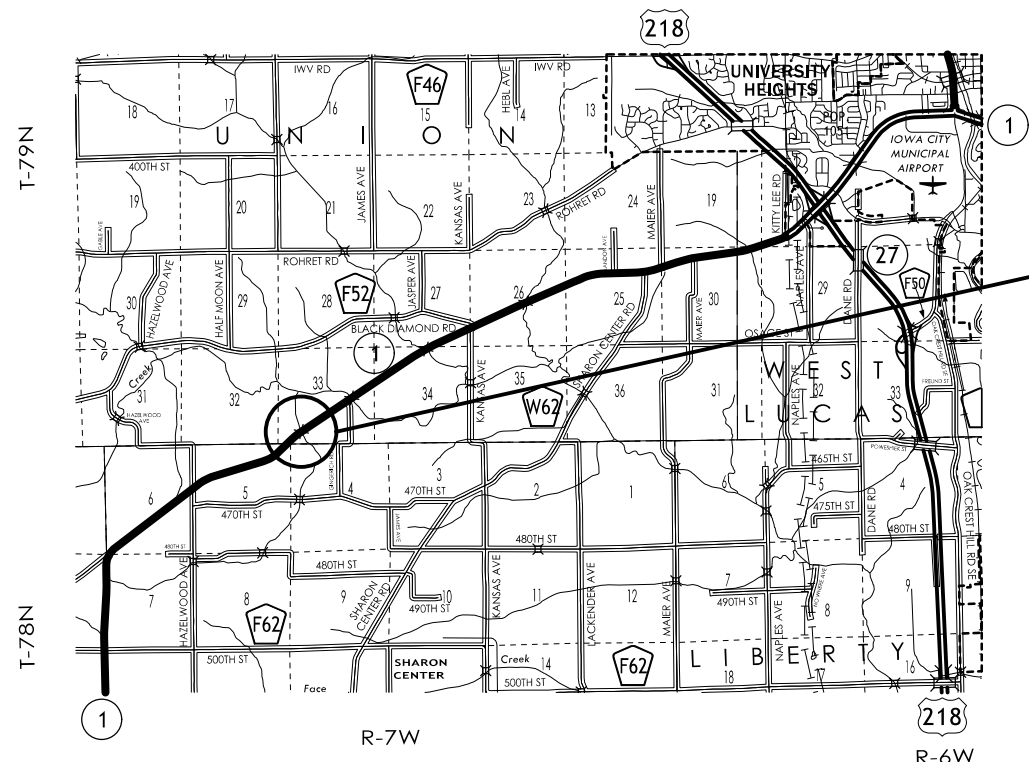

Project Location
Maint. No. 5277.3S001
FHWA No. 31670

CUT	(ML)	1,100 CY
FILL+30%	(ML)	5,900 CY
CONTRACTOR FURNISH		4,800 CY

DATES:
D4 PLAN - JUNE 18, 2019

DESIGN DATA RURAL

2018 AADT	7100	V.P.D.
2038 AADT	8200	V.P.D.
20-- DHV	--	V.P.H.
TRUCKS	7-8	%
Total Design ESALs	--	

INDEX OF SEALS

SHEET NO.	NAME	TYPE
A.1	Kelly C. Bell	Primary Signature Block

PRELIMINARY PLANS

Subject to change by final design.

D5 PLAN - Date: February 2, 2018

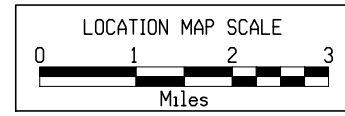
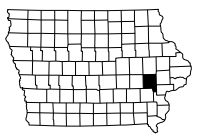

Normal section shown may be modified appropriately in areas of superelevated curves or other locations specifically designated by the Engineer.

See Plan & Profile sheets and cross sections for additional details of ditches and backslopes.

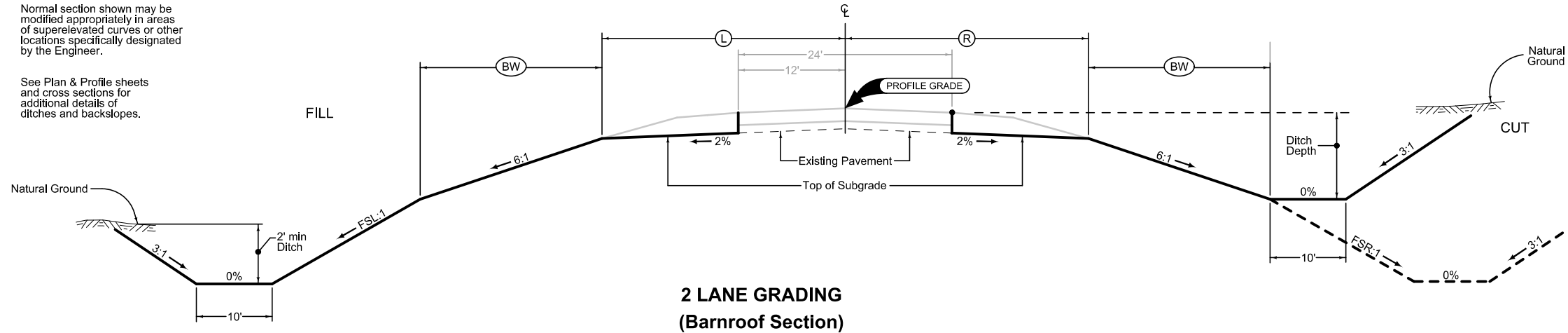

**2 LANE GRADING
(Barnroof Section)**

LOCATION		DIMENSIONS						
ROAD IDENTIFICATION	STATION TO STATION	Ⓛ Feet	Ⓡ Feet	Ⓛ Feet	Ⓡ Feet	Ⓛ Feet	Ⓡ Feet	
IA 1	517+90.00	518+75.00	--	29.6	--	0	--	6:1-4:1
IA 1	518+75.00	519+05.45	--	29.6-28.9	--	0	--	4:1-3:25:1
IA 1	519+05.45	519+27.99	--	28.9-32.0	--	0	--	3:25:1-3:1
IA 1	519+27.99	519+72.63	--	32.0	--	0-12	--	3:1-1.95:1
IA 1	519+72.63	520+46.93	--	32.0	--	12	--	1.95:1-2.15:1
IA 1	520+46.93	520+90.00	--	32.0	--	12-0.45	--	2.15:1-2.25:1
IA 1	520+90.00	520+92.41	--	32.0-31.9	--	0.45-0	--	2.25:1-3:1
IA 1	520+92.41	521+14.11	--	31.9-28.6	--	0	--	3:1
IA 1	521+14.11	522+15.00	--	28.6	--	0	--	3:1
IA 1	517+90.00	518+00.00	32.0-29.6	--	0	--	6:1-4:1	--
IA 1	518+00.00	518+50.00	29.6-28.6	--	0	--	4:1-3:1	--
IA 1	518+50.00	519+05.48	28.6	--	0	--	3:1	--
IA 1	519+05.48	519+27.99	28.6-32.0	--	0	--	3:1	--
IA 1	519+27.99	519+72.66	32.0	--	0-12	--	3:1	--
IA 1	519+72.66	520+30.20	32.0	--	12	--	3:1-3.6:1	--
IA 1	520+30.20	520+65.00	32.0	--	12	--	3.6:1-3:1	--
IA 1	520+65.00	520+90.00	32.0	--	12	--	3:1	--
IA 1	520+90.00	520+93.66	32.0	--	12-2.02	--	3:1	--
IA 1	520+93.66	520+95.00	32.0-28.6	--	2.02-0	--	3:1	--
IA 1	520+95.00	522+15.00	28.6	--	0	--	3:1	--

Combination Shoulder

Shoulder Jointing:
Longitudinal joint: B

		2_C_ Modified	
STATION TO STATION		(P) Feet	(G) Feet
517+90.00	522+15.00	6.0	4.0

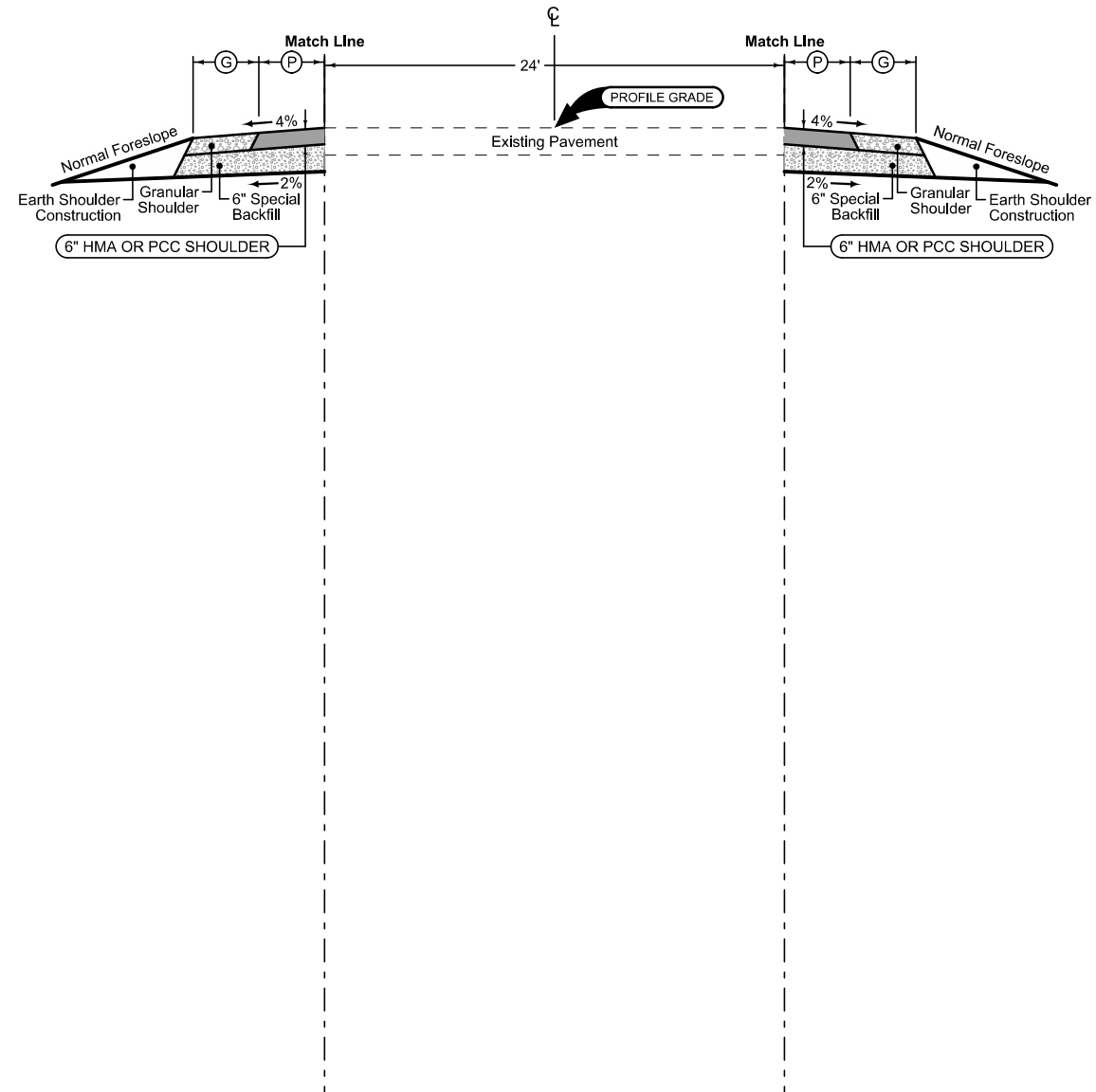

Combination Shoulder

Shoulder Jointing:
Longitudinal joint: B

		2_C_ Modified	
STATION TO STATION		(P) Feet	(G) Feet
517+90.00	522+15.00	6.0	4.0

See Tab 100-24 or 100-25 for pavement quantities.
See Tab 112-9 for shoulder quantities.

Iowa Highway 1

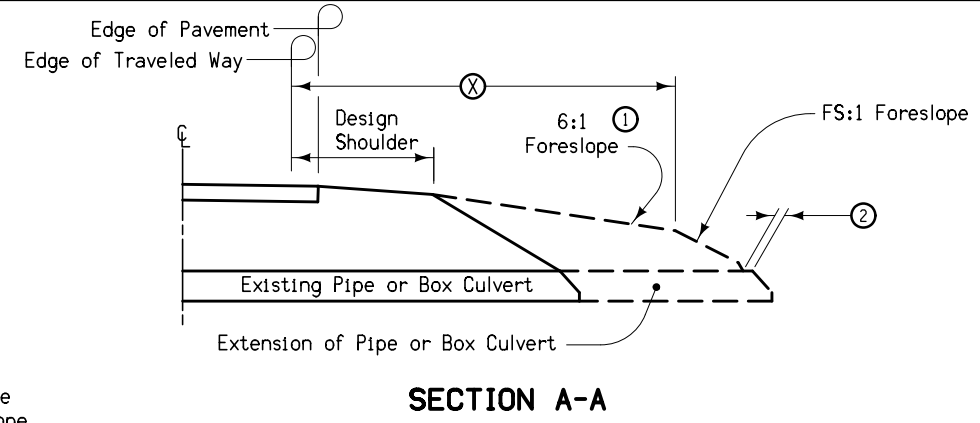
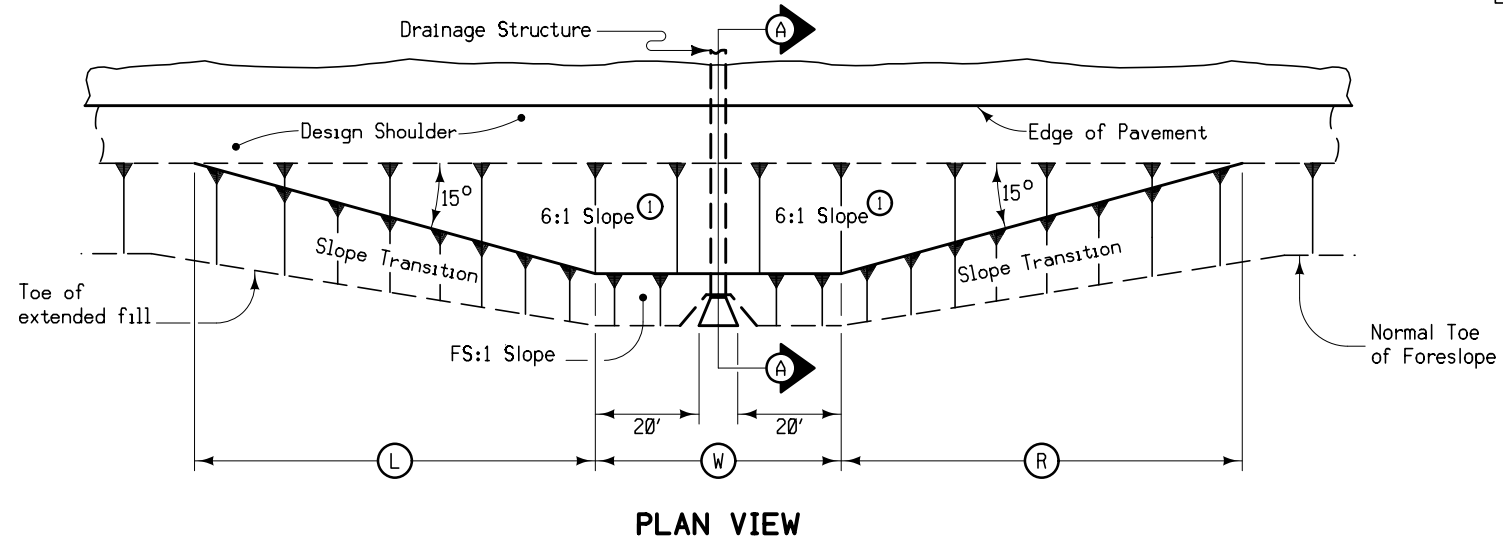

STRUCTURE LOCATION		(W)	(L)	(R)	(X)	(FS)
STATION	SIDE	Feet	Feet	Feet	Feet	
520+10.00	Rt	82	67	67	32	3:1
520+10.00	Lt	117	5	67	32	3:1

- Notes:
- At locations where an extended or newly constructed drainage structure extends beyond the normal foreslope cover, flatten the foreslope as indicated so as to cover the structure. Minimum earth cover is 6".
 - ① Slope may be flatter than 6:1.
 - ② 6" Minimum for pipe installations or to top of headwall on R.C.B.
 - (W) = Pipe or R.C.B. opening width plus 20 feet each side.

**BARNROOF FORESLOPE
AT DRAINAGE STRUCTURE**

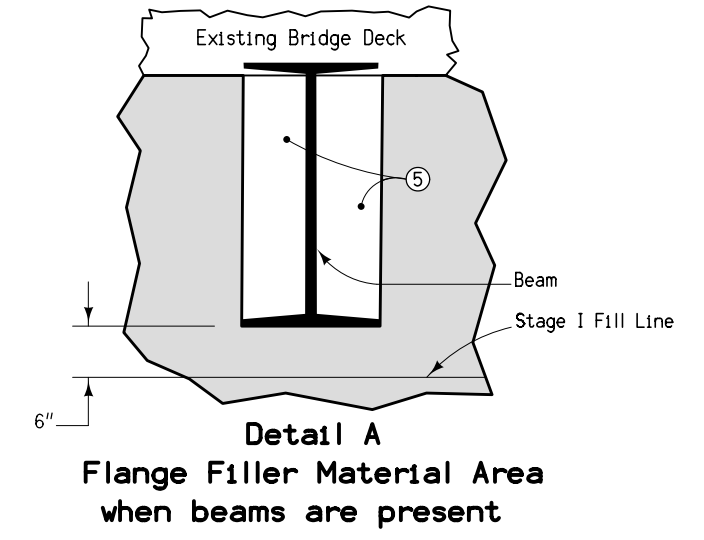
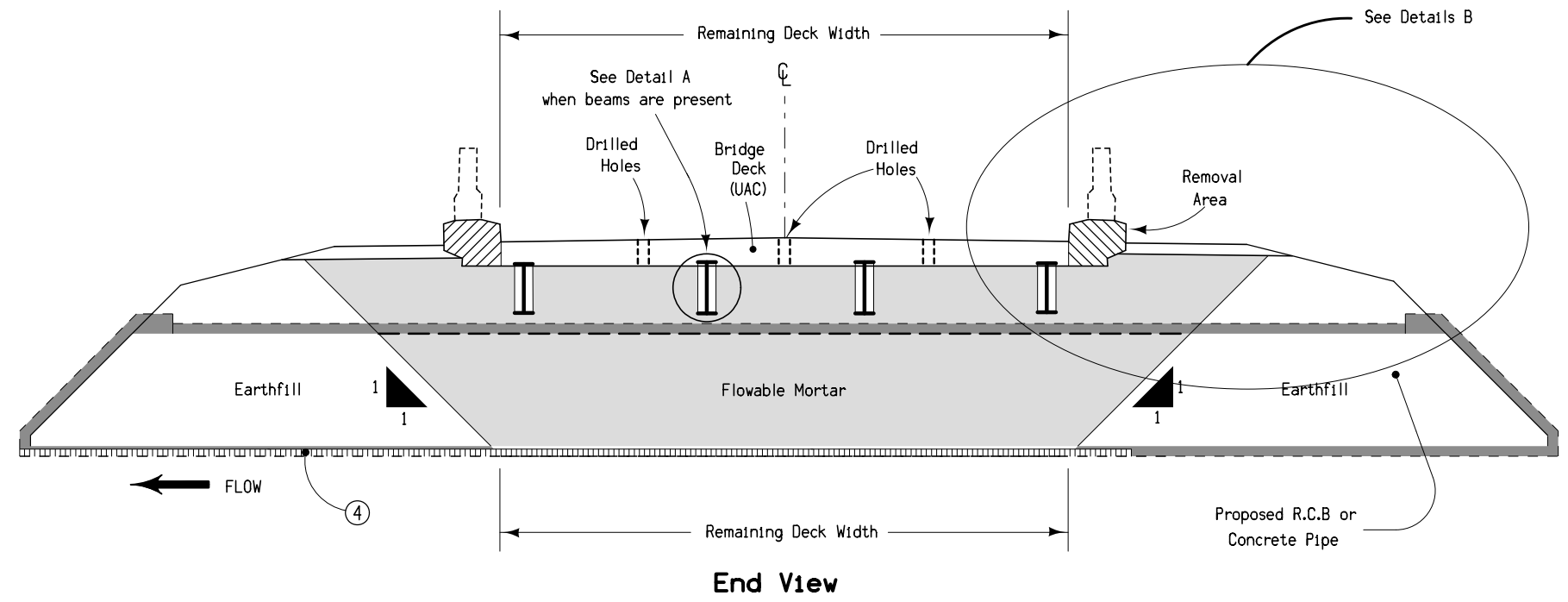

Detail A
Flange Filler Material Area
when beams are present

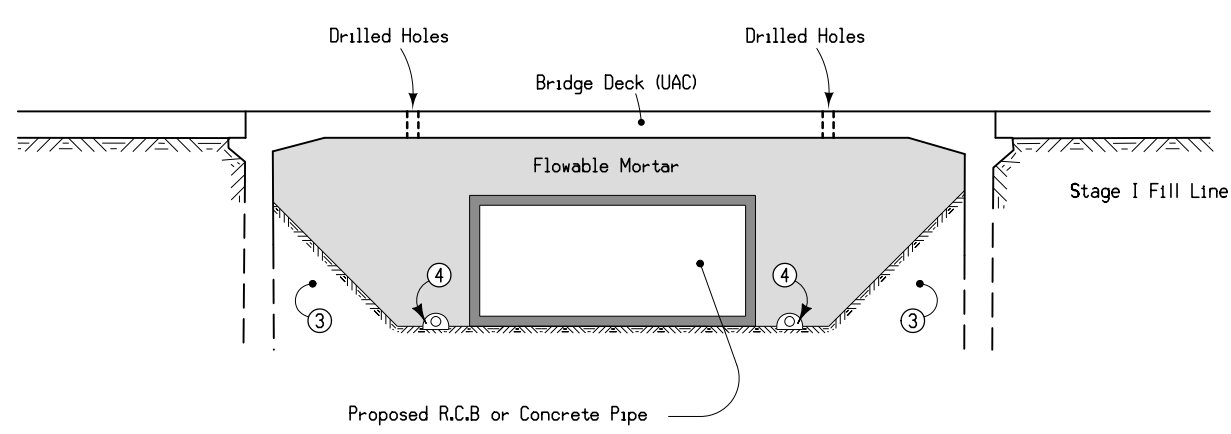

Section at Centerline

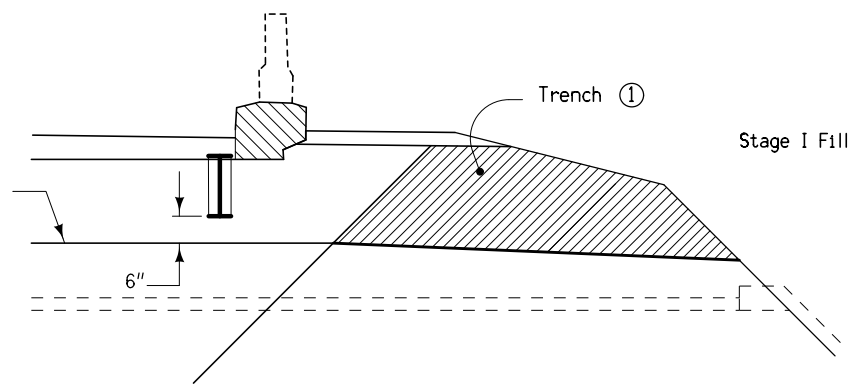

Detail B (Beam Bridge)

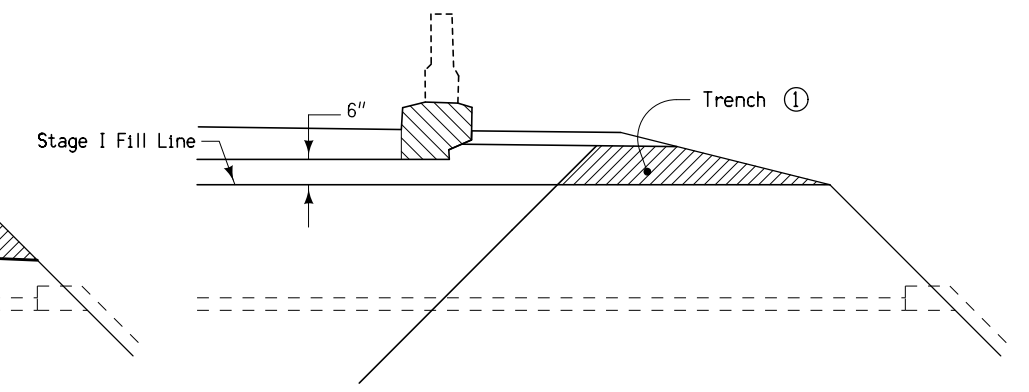

Detail B (Slab Bridge)

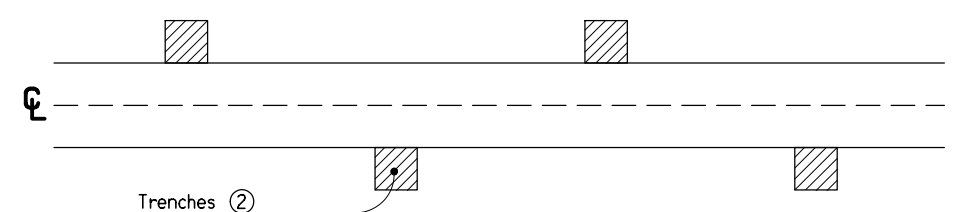

Trench Layout

- ① Cut trenches in the soil plug to provide drainage for the flowable mortar. Backfill the trenches with open graded crushed stone, gravel, or recycled PCC to allow water to drain. Backfill material is incidental to flowable mortar.
- ② Place trenches at 20' spacing with a minimum of two trenches on each side of the roadway.
- ③ Existing embankment.
- ④ 4" Subdrain with 4" cover of porous backfill at flowline elevation of culvert.
- ⑤ Place Flange Filler Material to fill pocket area between flanges to prevent flowable mortar from building up. Flange Filler Material is incidental to flowable mortar.

**FILL FOR CULVERT USED
IN BRIDGE REPLACEMENTS
WITH RESTRICTED HEIGHT**

SURVEY SYMBOLS

- OUT Tile Outlet
- D Centerline Draw or Stream (Down)
- BL Topo Breakline
- TIL Tile Line
- TW Top of Water
- RIP Rip-Rap
- DU Centerline Draw or Stream (Up)
- TEV Evergreen Tree
- SI Sign
- TDC Tree Deciduous
- FW Wire Fence
- TLNL Tree Line Left
- D Centerline Draw or Stream (Down)
- DU Centerline Draw or Stream (Up)

UTILITY LEGEND

- F0 - FO1D Fiber Optic (ICN) Iowa Communications Network - Quality D
- F02 - FO2D Fiber Optic (KAT) Kalona Cooperative Telephone - Quality D
- PPA Power Pole Eastern Iowa Light & Power
- G - G01 Gas Line

PLAN VIEW COLOR LEGEND OF PLAN AND PROFILE SHEETS

LINEWORK	Design Color No.	Description
Green	(2)	Existing Topographic Features and Labels
Blue	(1)	Proposed Alignment, Stationing, Tic Marks, and Alignment Annotation
Magenta	(5)	Existing Utilities
SHADING		
Design Color No.	Description	
Yellow	(4)	Highlight for Critical Notes or Features
Red	(3)	Delineates Restricted Areas
Lavender	(9)	Temporary Pavement Shading
Gray, Light	(48)	Proposed Pavement Shading
Gray, Med	(80)	Proposed Granular Shading
Gray, Dark	(112)	Proposed Grade and Pave Shading "In conjunction with a paving project"
Brown, Light	(236)	Grading Shading
Tan	(8)	Proposed Sidewalk Shading
Blue, Light	(230)	Proposed Sidewalk Landing Shading
Pink	(11)	Proposed Sidewalk Ramp Shading

PROFILE VIEW COLOR LEGEND OF PLAN AND PROFILE SHEETS

LINEWORK	Design Color No.	Description
Green	(2)	Existing Ground Line Profile
Blue	(1)	Proposed Profile and Annotation
Magenta	(5)	Existing Utilities
Blue, Light	(230)	Proposed Ditch Grades, Left
Black	(0)	Proposed Ditch Grades, Median
Rust	(14)	Proposed Ditch Grades, Right

- Reference Point
- Station
- Survey Line
- Section Corner
- Ground Line Intercept
- Saw Cut
- Guardrail
- Trench Drain
- High Tension Cable Guardrail
- Sheet Pile
- Pavement Removal
- Clearing & Grubbing Area

RIGHT-OF-WAY LEGEND

- Proposed Right-of-Way
- Existing Right of Way
- Existing and Proposed Right-of-Way
- Easement and Existing Right-of-Way
- Easement (Temporary)
- Easement
- Access Control
- Property Line

PLAN AND PROFILE LEGEND AND SYMBOL INFORMATION SHEET

(COVERS SHEET SERIES D)

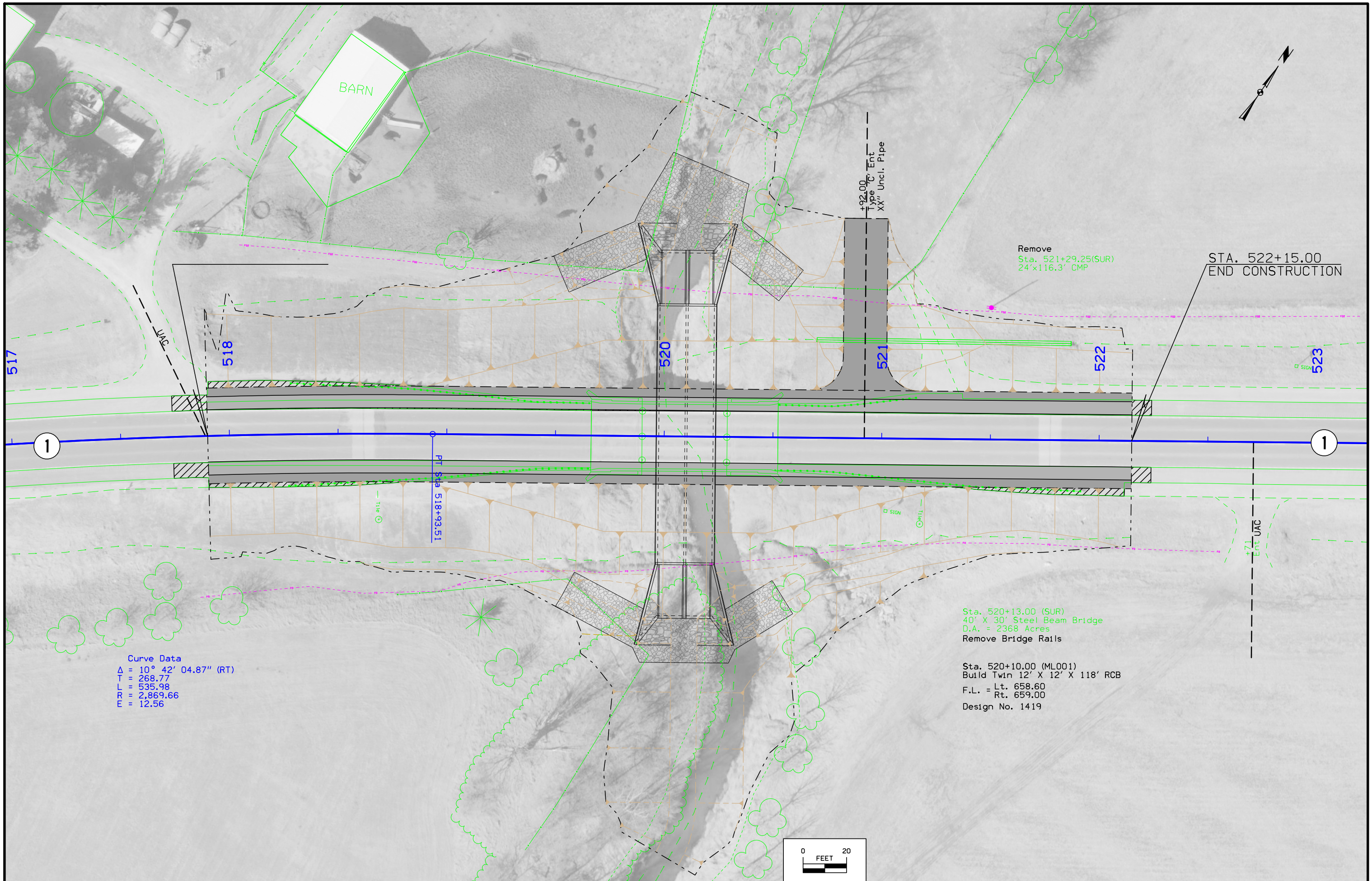

Curve Data
 $\Delta = 10^\circ 42' 04.87''$ (RT)
 T = 268.77
 L = 535.98
 R = 2,869.66
 E = 12.56

Sta. 520+13.00 (SUR)
 40' X 30' Steel Beam Bridge
 D.A. = 2368 Acres
 Remove Bridge Rails

Sta. 520+10.00 (ML001)
 Build Twin 12' X 12' X 118' RCB
 F.L. = Lt. 658.60
 Rt. 659.00
 Design No. 1419

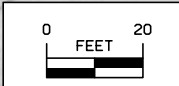

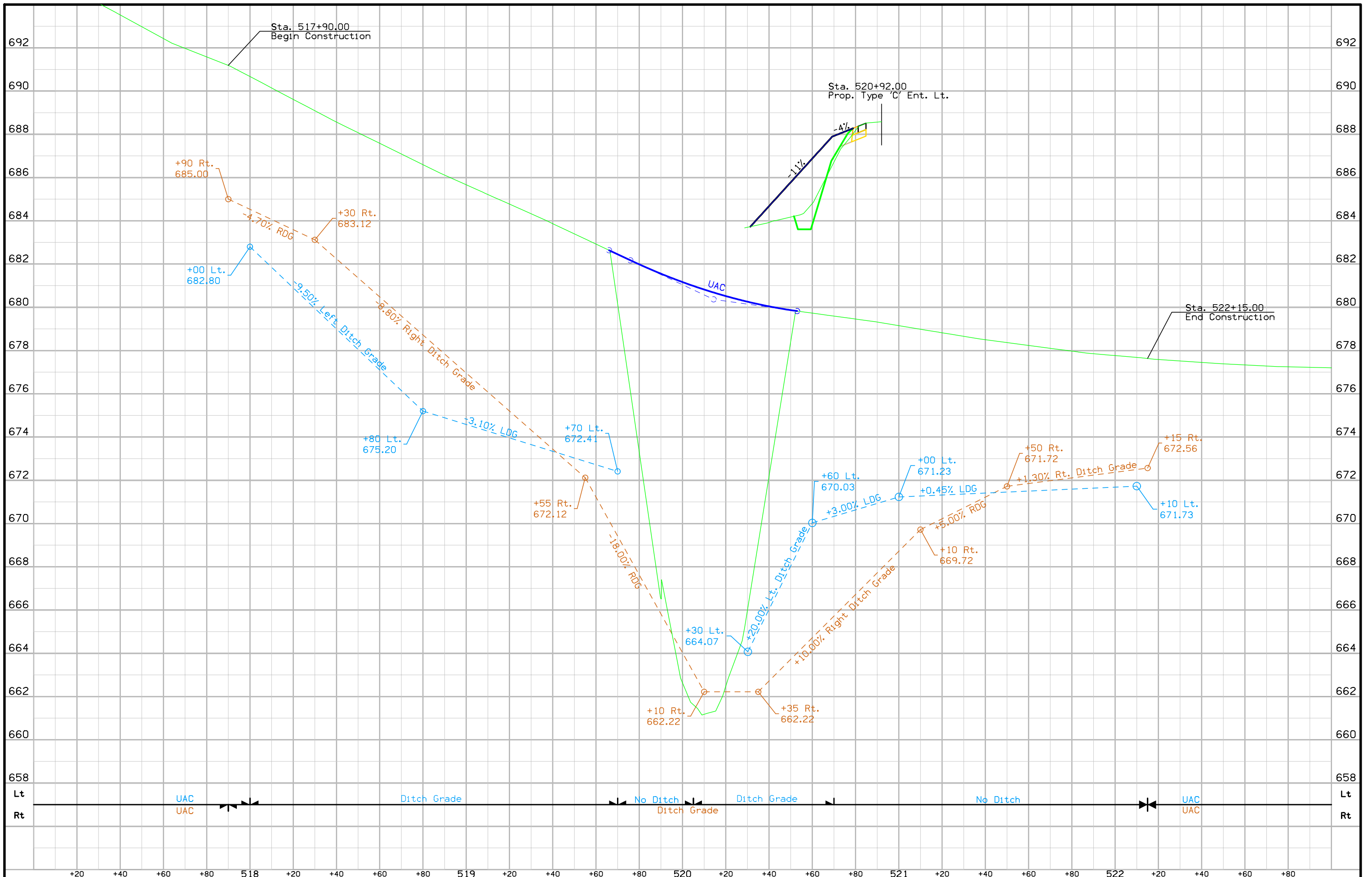

Survey Information

SAP 834.1
County: Johnson
PIN: 15-52-001-010
Project Number: BRF-001-5(108)--38-52
Location: Stream 2.1 mi S of Co Rd F52
Type of Work: RCB Culvert Replacement - Twin Box
Project Directory: 5200101015

General Information

Measurement units for this survey are US survey feet. This survey is for replacement of bridge with a twin 10 ft. x 12 ft. x 112ft. reinforced concrete box culvert on existing profile, using the flowable mortar method of construction. Project datum and control information is provided by Design Survey Office. This project is a Partial DTM with Photo control.

Vertical Control

Vertical datum for this survey is NAVD88 (Computed using Geoid12A). Benchmarks were placed throughout the project using post processed static observations relative to Pts. 1 and Johnson County Pt. 220. A minimum of 6hrs of data was simultaneously collected on each of these primary control points.

This survey observed 1 Johnson County Control Monument with published NAVD88 Geoid03 heights to compare to local ground control:
Point name 220 Elev. of 758.49'
Survey Elev. = 758.46'

Horizontal Control

The project coordinate system for this survey is Modified Iowa State Plane South Zone (U.S. Survey Feet). This survey control is relative to IaRTN reference stations. IaRTN Reference Station coordinates are relative to the National Reference Station network datum: NAD83 (2011) for Epoch 2010.00.

The project coordinate system is modified from Iowa State Plane South at project point 1 project coordinates of N= 591605.026, E= 2144428.984 (US ft.) All project points are scaled about this point using a scale factor of 1.000052919307.

Additional control points were placed throughout the project using post processed static observations relative to Pts. 1 and 2. A minimum of 6hrs of data was simultaneously collected on each point.

Alignment Information

The horizontal alignment for this survey is a retrace of As-built Plans No F-9(7) .Survey stationing was equated to the plan PC station 493+15.7 and run ahead without equation throughout the survey.

Utility Information

Sub-Surface Utility Mapping Quality Level is in accordance with CI/ASCE 38-02 Standard Guidelines for the Collection and Depiction of Existing Subsurface Utility Data.

Remark abbreviations
QLD – Quality Level D Lowest guideline quality level

All utilities were located within a week and to the boundaries requested. Locates had to be recalled due to the land owner to the North pulling the flags. Land owner admitted this in a conversation on 9/12/16.

Locate Request (#161930201) on 7/12/2016. The following companies were notified:

CONTROL POINT VICINITY MAP

This map is a guide to the vicinity of the primary project control points
Primary control is for use with RTK base stations and for RTN validation.
Future surveys will use primary project control to establish temporary
control as needed for construction or other surveying applications.

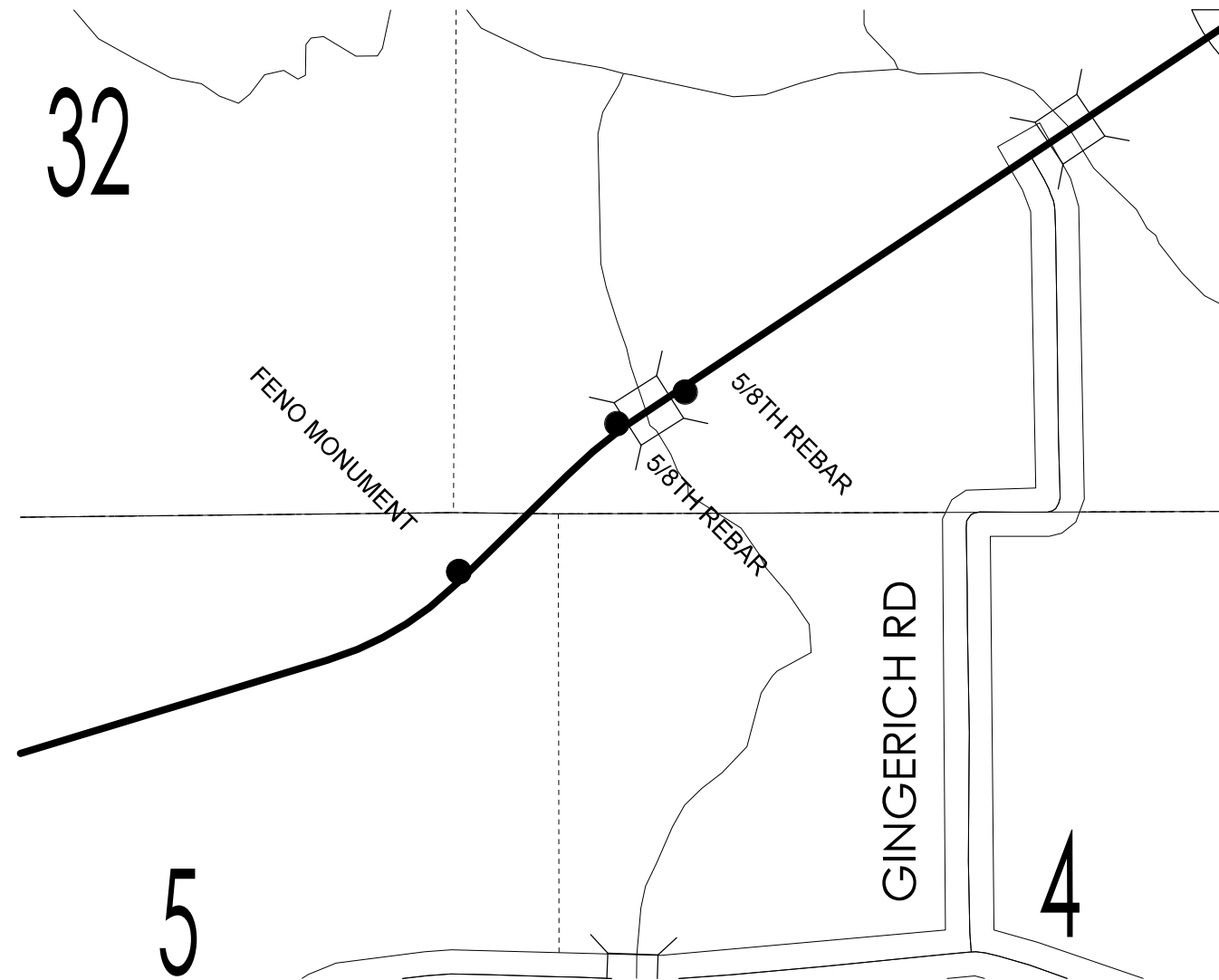

HORIZ. DATUM: NAD83(2011) EPOCH 2013.00

VERT. DATUM: NAVD88

State Plane South

Coordinate listing from next sheet will be used with laRTN for monument
recovery. No other reference ties are given.

HORIZONTAL AND VERTICAL PROJECT CONTROL COORDINATE LISTING

HORIZ. DATUM: NAD83(2011) EPOCH 2013.00

VERT. DATUM: NAVD88

State Plane South

Point Name	Northing	Easting	Elevation	Feature	Description
4	587753.9	2138922.01	742.91	CP	FENO MONUMENT
104	588723.31	2139958.3	689.08	CP	5/8TH REBAR
4002	588930.39	2140406.05	675.79	CP	5/8TH REBAR

IA 1 D5 Submittal

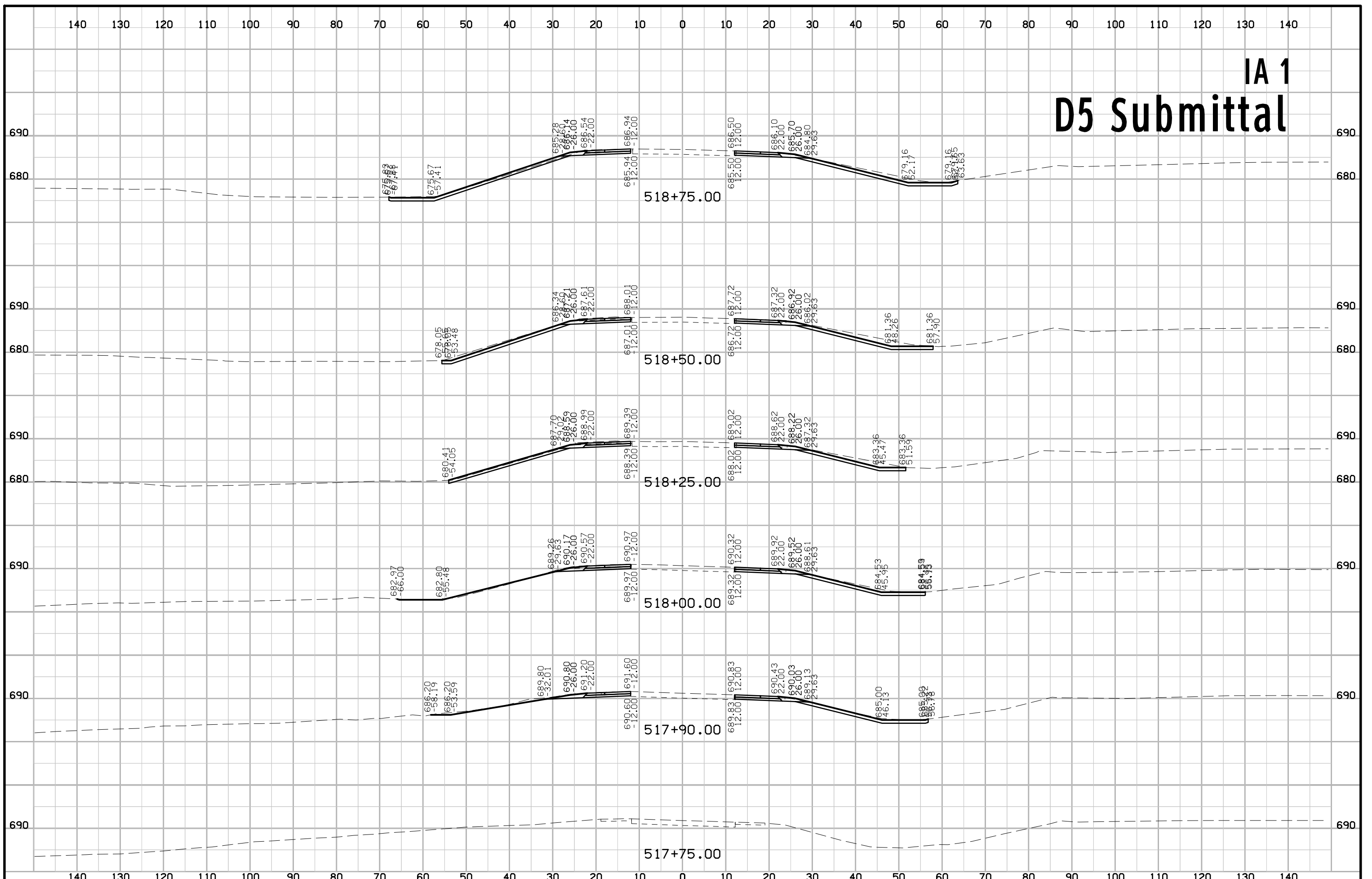

IA 1 D5 Submittal

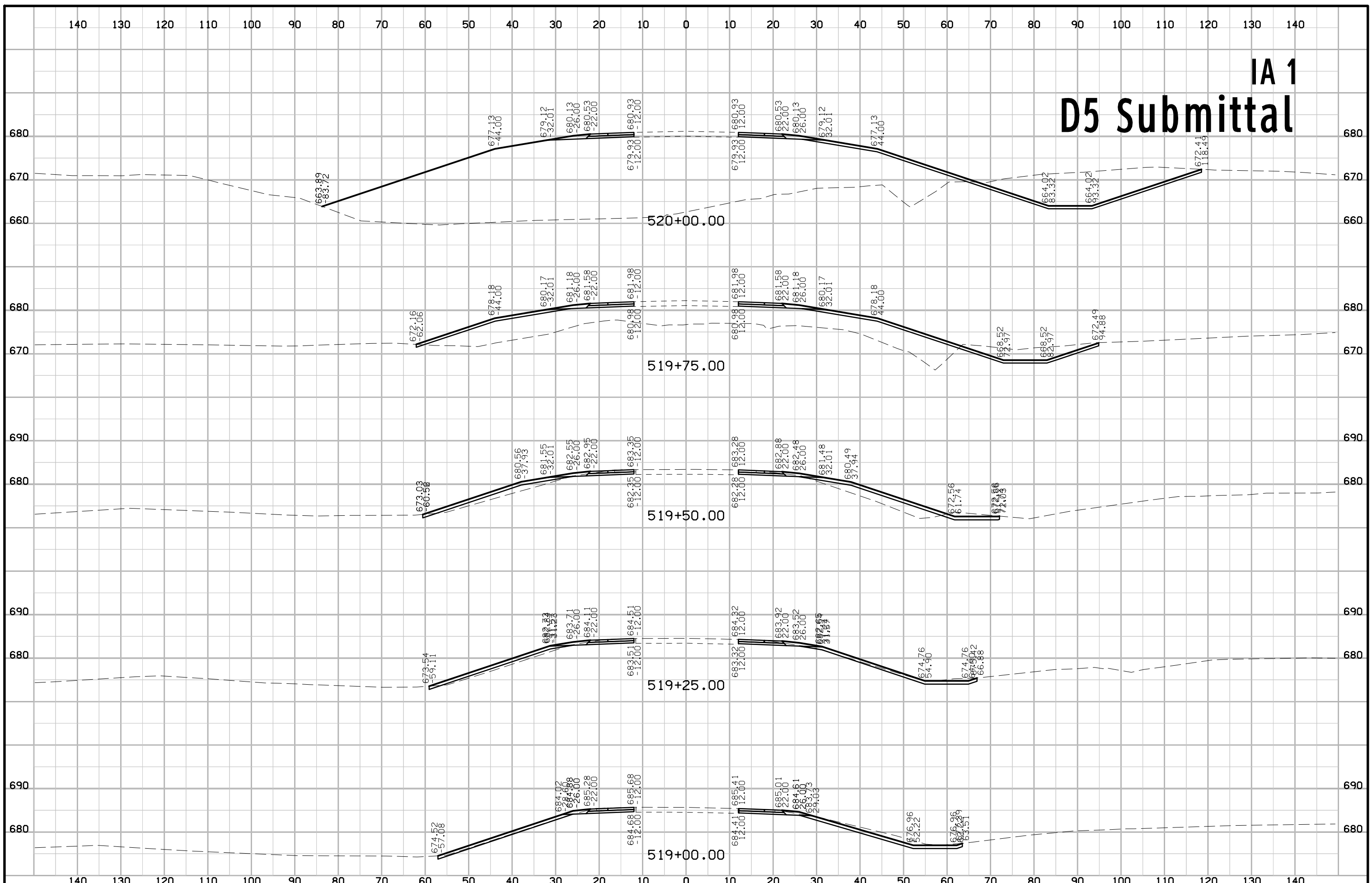

IA 1 D5 Submittal

